Battery
Accommodation



Contents

Steel Stands	2
Constructional & Component Details	2
Stand Dimensions, Sizing Method & Examples	3-5
a) PowerSafe® V	
b) PowerSafe® V Front Terminal	
Electrical Connections	6
a) Single Series Battery on Single Row Stand	
b) Single Series Battery on Double Row Stand	
c) Series Parallel Batteries	
d) Transition Boxes	
Battery Room Layout	7-9
a) Height	
b) Width	
c) Length	
d) Examples	
PowerSafe® V General Specifications	10



Steel Stands

A comprehensive range of steel stands has been specifically designed to provide a compact and effective arrangement for PowerSafe® V batteries whilst retaining the requirements of electrical and mechanical safety, ease of installation and access during operation for taking meter readings.

Steel stands are available as free standing units (complete with adjustable insulating feet), anti-shock units (for offshore or

unpredictable environments) or seismic units (for areas of geological unpredictability or sites such as nuclear power stations). Each stand type is configured to provide optimum access for both installation and maintenance and supplied complete with accessories for wall or floor fixing and attachment of ancillary equipment.

Cabinets and other special designs can be engineered and supplied to meet particular specifications.

Constructional & Component Details

Each stand assembly, which is individually tailored to the battery type, is built from 3 basic components:

- frame, fabricated from square steel tube
- runner, fabricated from square steel tube
- flat steel tie-bar

These component parts are factory finished with a high quality electro-statically deposited epoxy powder coating which, in addition to its high dielectric resistance, is acid and saline resistant, fireproof, vermin proof, scratch resistant and impact resistant.

The base of each frame leg is fitted with an adjustable insulating foot assembly to allow precise levelling on uneven floors. Each stand kit includes all the necessary fastener sets, which are dimensionally matched to the pre-drilled holes in frames, runners and tie-bars, to ensure a rigid assembly.

For front terminal monoblocs, the rear runner of each tier has an extended top back edge for locating the rear face of the unit during battery installation.

- 1 Runner hole plug
- 2 Set-screw
- 3 Runner end bung
- 4 Runner
- 5 Crossbearer
- 6 Frame end bung
- 7 Plain washer
- 8 Spring washer
- 9 Nut
- 10 Nut-cap
- 11 Plain washer
- 12 Spring washer
- 13 Set-screw
- 14 Nut-cap
- 15 Tie-bar
- 16 Frame plug
- 17 Threaded insert
- 18 Plain washer
- 19 Lock-nut
- 20 Adjustable foot

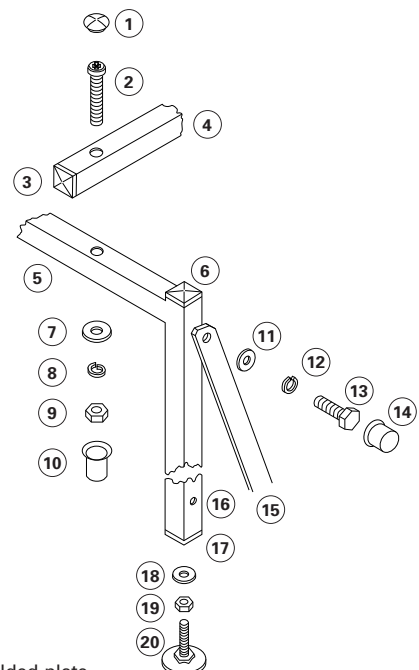

Note: Item 17 (threaded insert) is replaced by a welded plate drilled and tapped to suit the foot for heavy duty applications.

Stand Dimensions, Sizing Method & Examples













By following the simple guidelines hereafter, the user can readily calculate the space required by the various standard range of steel stand options to make best use of the accommodation available.







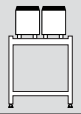

a) PowerSafe® V

For these stand designs, cells/units of rectangular plan dimensions (ie. all except 12V80) are accommodated in a 'side-by-side' arrangement along the stand to minimise battery length dimension. If depth of accommodation is restricted, non-standard design steel

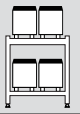
stands can be provided to accommodate an 'end to end' cell/unit configuration, but this will result in an increase of required stand length (approx 1.5 times increase).

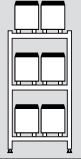
DIMENSIONS		Single Tier Single Row	Single Tier Double Row	Double Tier Single Row	Double Tier Double Row	Triple Tier Single Row	Triple Tier Double Row	4 Tier Single Row	4 Tier Double Row	5 Tier Double Row	6 Tier Double Row
Types	Dimensions (mm)										
12V45	Width	275	450	275	450	275	450	305	480	480	480
	Height over Terminals	621	621	791	791	1186	1186	1581	1581	1976	2371
	Overall Height Required	771	771	941	941	1336	1336	1731	1731	2126	2521
	Cell Centres	220	220	220	220	220	220	220	220	220	220
12V55	Width	275	450	275	450	275	450	305	480	480	480
	Height over Terminals	621	621	791	791	1186	1186	1581	1581	1976	2371
	Overall Height Required	771	771	941	941	1336	1336	1731	1731	2126	2521
	Cell Centres	273	273	273	273	273	273	273	273	273	273
12V70	Width	275	450	275	450	275	450	305	480	480	480
	Height over Terminals	621	621	791	791	1186	1186	1581	1581	1976	2371
	Overall Height Required	771	771	941	941	1336	1336	1731	1731	2126	2521
	Cell Centres	316	316	316	316	316	316	316	316	316	316
12V80	Width	320	520	320	520	320	520	320	520	520	520
	Height over Terminals	800	800	800	800	1195	1195	1590	1590	1985	2380
	Overall Height Required	950	950	950	950	1345	1345	1740	1740	2135	2530
	Cell Centres	368	368	368	368	368	368	368	368	368	368
4V105 6V105	Width	320	520	320	520	320	520	320	520	520	520
	Height over Terminals	800	800	800	800	1195	1195	1590	1590	1985	2380
	Overall Height Required	950	950	950	950	1345	1345	1740	1740	2135	2530
	Cell Centres	193	193	193	193	193	193	193	193	193	193
6V130	Width	325	550	325	550	325	550	355	580	580	580
	Height over Terminals	635	635	805	805	1200	1200	1595	1595	1990	2385
	Overall Height Required	785	785	955	955	1350	1350	1745	1745	2140	2535
	Cell Centres	245	245	245	245	245	245	245	245	245	245
4V155	Width	320	520	320	520	320	520	320	520	520	520
	Height over Terminals	800	800	800	800	1195	1195	1590	1590	1985	2380
	Overall Height Required	950	950	950	950	1345	1345	1740	1740	2135	2530
	Cell Centres	204	204	204	204	204	204	204	204	204	204
6V155	Width	430	700	430	700	430	700	430	700	700	700
	Height over Terminals	800	800	800	800	1195	1195	1590	1590	1985	2380
	Overall Height Required	950	950	950	950	1345	1345	1740	1740	2135	2530
	Cell Centres	204	204	204	204	204	204	204	204	204	204
6V170	Width	430	700	430	700	430	700	430	700	700	700
	Height over Terminals	825	825	825	825	1220	1220	1615	1615	2010	2405
	Overall Height Required	975	975	975	975	1370	1370	1765	1765	2160	2555
	Cell Centres	177	177	177	177	177	177	177	177	177	177

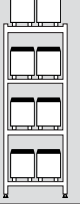
Stand Dimensions, Sizing Method & Examples

DIMENSIONS		Single Tier Single Row	Single Tier Double Row	Double Tier Single Row	Double Tier Double Row	Triple Tier Single Row	Triple Tier Double Row	4 Tier Single Row	4 Tier Double Row	5 Tier Double Row	6 Tier Double Row
Types	Dimensions (mm)										
2V200	Width	325	550	325	550	325	550	355	580	580	580
	Height over Terminals	661	661	831	831	1226	1226	1621	1621	2016	2411
	Overall Height Required	811	811	981	981	1376	1376	1771	1771	2166	2561
	Cell Centres	112	112	112	112	112	112	112	112	112	112
4V230	Width	430	700	430	700	430	700	430	700	700	700
	Height over Terminals	800	800	800	800	1195	1195	1590	1590	1985	2380
	Overall Height Required	950	950	950	950	1345	1345	1740	1740	2135	2530
	Cell Centres	204	204	204	204	204	204	204	204	204	204
2V275	Width	250	400	250	400	250	400	280	430	430	430
	Height over Terminals	661	661	831	831	1226	1226	1621	1621	2016	2411
	Overall Height Required	811	811	981	981	1376	1376	1771	1771	2166	2561
	Cell Centres	209	209	209	209	209	209	209	209	209	209
2V310	Width	320	520	320	520	320	520	320	520	520	520
	Height over Terminals	800	800	800	800	1195	1195	1590	1590	1985	2380
	Overall Height Required	950	950	950	950	1345	1345	1740	1740	2135	2530
	Cell Centres	204	204	204	204	204	204	204	204	204	204
2V320	Width	320	520	320	520	320	520	320	520	520	520
	Height over Terminals	815	815	815	815	1210	1210	1605	1605	2000	2395
	Overall Height Required	965	965	965	965	1360	1360	1755	1755	2150	2545
	Cell Centres	209	209	209	209	209	209	209	209	209	209
2V400/2	Width	320	520	320	520	320	520	320	520	520	520
	Height over Terminals	840	840	840	840	1235	1235	1630	1630	2025	2420
	Overall Height Required	990	990	990	990	1385	1385	1780	1780	2175	2570
	Cell Centres	209	209	209	209	209	209	209	209	209	209
2V460/4	Width	430	700	430	700	430	700	430	700	700	700
2V460/6	Height over Terminals	800	800	800	800	1195	1195	1590	1590	1985	2380
	Overall Height Required	950	950	950	950	1345	1345	1740	1740	2135	2530
	Cell Centres	204	204	204	204	204	204	204	204	204	204
2V500/2	Width	350	600	350	600	350	600	380	630	630	630
	Height over Terminals	661	661	831	831	1226	1226	1621	1621	2016	2411
	Overall Height Required	811	811	981	981	1376	1376	1771	1771	2166	2561
	Cell Centres	209	209	209	209	209	209	209	209	209	209
2V500/6	Width	430	700	430	700	430	700	430	700	700	700
	Height over Terminals	815	815	815	815	1210	1210	1605	1605	2000	2395
	Overall Height Required	965	965	965	965	1360	1360	1755	1755	2150	2545
	Cell Centres	209	209	209	209	209	209	209	209	209	209

METHOD

- Battery height:** Dimension as per table according to number of tiers (1, 2, 3, 4, 5 or 6) selected
- Battery width:** Dimension as per table according to number of rows (single or double) selected
- Battery length:**
- 1) Calculate stand runner length L_1 by applying formula $L_1 = (\text{number of cells/units per row} \times \text{cell centres}) + 25\text{mm}$
 - 2) Add 100mm (50mm per end) for inter-tier connectors
Hence, battery length $L = L_1 + 100\text{mm}$

EXAMPLE

Example: 56 units type 6V105 on TTDR steel stand

- Battery height: 1195mm (over terminals)
- Battery width: 520mm
- Battery length:
 - 1) (a) Divide the total number of units by the total number of rows and round up to next full number
56 units / 6 rows = 9.33
Therefore stand needs to be '10 units long'
 - (b) $L_1 = (10 \times 193) + 25\text{mm} = 1955\text{mm}$
- 2) Add 100mm for inter-tier connectors
Battery length $L = 2055\text{mm}$

Note: The maximum length of a single stand is approximately 3 metres. For lengths in excess of 3 metres multiple stands are supplied.

b) PowerSafe® V Front Terminal

DIMENSIONS		Single Tier	Double Tier	Triple Tier	4 Tier	5 Tier	6 Tier
Types	Dimensions (mm)						
12V30F	Width	450	450	450	455	455	455
	Height	335	585	835	1085	1335	1585
	Unit Centres	107	107	107	107	107	107
12V38F	Width	450	450	450	455	455	455
	Height	360	635	910	1185	1460	1735
	Unit Centres	107	107	107	107	107	107
12V62F	Width	450	450	450	455	455	455
	Height	440	790	1140	1490	1840	2190
	Unit Centres	107	107	107	107	107	107
12V92F	Width	550	550	550	555	555	555
	Height	440	800	1160	1520	1880	2240
	Unit Centres	115	115	115	115	115	115
12V100FC	Width	550	550	550	555	555	555
	Height	463	838	1213	1588	1963	2338
	Unit Centres	118	118	118	118	118	118
12V101F	Width	700	700	700	705	705	705
	Height	411	786	1161	1536	1911	2286
	Unit Centres	120	120	120	120	120	120
12V125F	Width	750	750	750	755	755	755
	Height	492	892	1292	1692	2092	2492
	Unit Centres	115	115	115	115	115	115
12V155FS	Width	750	750	750	755	755	755
	Height	459	834	1209	1584	1959	2334
	Unit Centres	135	135	135	135	135	135
12V170FS	Width	750	750	750	755	755	755
	Height	459	834	1209	1584	1959	2334
	Unit Centres	135	135	135	135	135	135
12V170F	Width	750	750	750	755	755	755
	Height	492	892	1292	1692	2092	2492
	Unit Centres	135	135	135	135	135	135
12V190F	Width	750	750	750	755	755	755
	Height	492	892	1292	1692	2092	2492
	Unit Centres	135	135	135	135	135	135

METHOD

Battery height: Dimension as per table according to number of tiers (1, 2, 3, 4, 5 or 6) selected

Battery width: Dimension as per table depending upon type of unit

Battery length: Calculate stand length by applying formula $L = (\text{number of units per tier} \times \text{unit centres}) + 25\text{mm}$

EXAMPLE

Example: 12 units type 12V170F on 4 tier steel stand

- Battery height: 1692mm
- Battery width: 755mm
- Battery length:
 - 1) Divide the total number of units by the total number of tiers and round up to next full number
 $12 \text{ units} / 4 \text{ tiers} = 3$
 Therefore stand needs to be '3 units long'
 - 2) $L = (3 \times 135) + 25\text{mm} = 430\text{mm}$
 Battery length $L = 430\text{mm}$

Note: PowerSafe V front terminal batteries have been purposely designed for accommodation in customer power racks and cabinets where depth restrictions may preclude multi-row arrangements. In addition the standard inter-unit connector effects a 10mm space between units in accordance with EN 50272-2.

Electrical Connections

Where batteries are ordered complete with stands, all necessary inter-cell/unit connectors (including insulated inter-row and inter-tier connectors, depending upon battery type) are provided.

The following general notes indicate the standard methods employed for the electrical connection sequence within the battery and the resulting battery terminal position.

a) Single Series Battery on Single Row Stand

The series connector run is along the length of the stand and then, in the case of multi-tier stand vertically down, via inter-tier connector, to the next tier such that main battery terminals are located:

- at opposite ends of the stand for odd numbers of tiers or
- at the same end of the stand for an even number of tiers

b) Single Series Battery on Double Row Stand

The series connector run is along the length of the stand on back (or front) row then horizontal across to front (or back) row via the inter-row connector and back towards starting point end of the stand.

In the case of a multi-tier stand, the connection sequence is continued vertically down via the inter-tier connector and maintained by connecting along the row to the opposite end of the stand, followed by horizontal across row connection as the previous tier, such that the main battery terminals are at the same end of the stand irrespective of the number of tiers.

c) Series Parallel Batteries

It is normal practice to effect the electrical paralleling via the battery terminals as opposed to paralleling of individual cells. Therefore, where each series battery circuit is accommodated on its own stand and the parallel connection is made at a common bus bar point, the notes contained in a) and b) above are applicable.

However, where it is desirable to accommodate the total series parallel battery on the same stand, in order to effect a practical connection arrangement, it is essential that the stand design chosen not only matches the number of parallel strings involved (3 parallel strings on a single tier, double tier, 4 tier or 5 tier stand, would be impractical) but allows the main battery terminals to be suitably positioned to correspond with the desired locations of bus bars.

d) Transition Boxes

Transition boxes are also available to connect the battery main end leads (separate boxes for positive and negative) to outgoing cables or bus bars. Where necessary, it also affords a safe and convenient method of paralleling banks of cells. Transition boxes come complete with mounting plates and connectors.

Customers not using transition boxes should ensure that connections to the battery end terminals are well supported to avoid stress on the pillar seals.

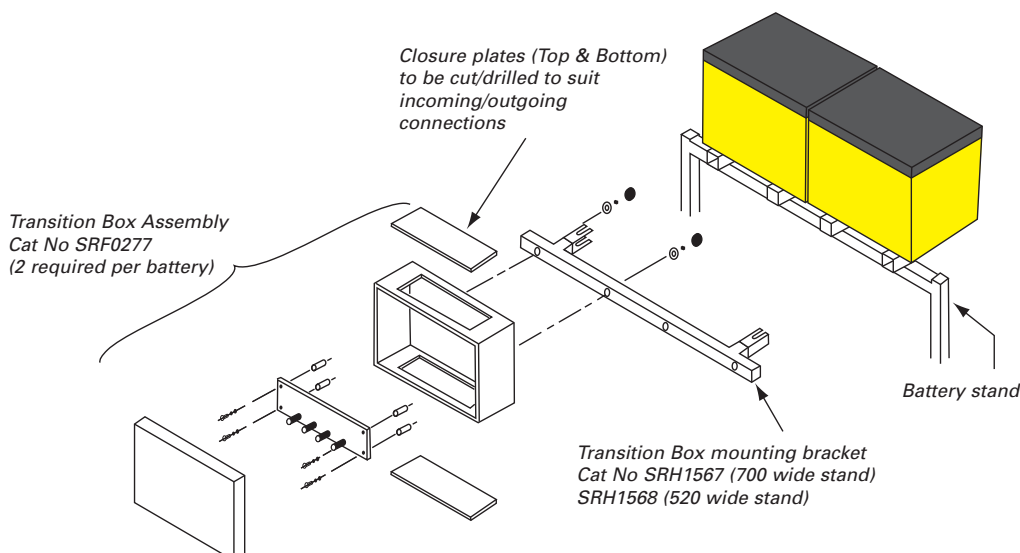

Space around a battery is not only highly desirable for safety reasons, but is a practical necessity to give sufficient access during installation and operation.

Batteries and stands should be installed in accordance with national/local standards (for instance EN 50272-2). In cases where there is currently no legislation to determine these aspects, the following minimum requirement recommendations are offered.

a) Height

The steel stands are designed to give sufficient working height above the units/cells. The overall height required dimension indicates the absolute minimum room height necessary to access the top tier cells/units (refer to tables on pages 3-5).

The main consideration in determining room height required is access for the operator (i.e. with low height battery arrangements, sufficient height for the operator to stand in and, with high battery arrangements, the need to reach up to the top tiers).

For safety reasons, brackets designed to steady the stand are supplied with stands of 5 tier and above, depending upon type. Please note that the space between the stand and wall may need to be reduced to accommodate the anchor bracket.

b) Width

The stands are designed so that they can be located along a wall with access from the front of the stand. In order to assemble the stand in situ, a minimum space of 100mm is required between the wall and the back of stand to facilitate the fitting of the stand tier-bar. In front of the stand, a working space of 600mm minimum will be necessary. This working space can be used as a common gangway if it is necessary to locate another battery on the opposite wall.

c) Length

In the case of a single stand located along a wall or where 2 stands are located, one along each side wall with centre gangway access, the minimum room length required is:

PowerSafe® V

the calculated battery length L (see pages 3-4)
+ 50mm at each end of the battery for access to connections etc.

Note: Where transition boxes are fitted, access of 600mm should be allowed at one end of the stand.

PowerSafe® V Front Terminal

the calculated battery length L (see page 5)
+ 100mm at each end of the stand.

Note: Where transition boxes are fitted, the minimum room length required is the calculated stand length L + 450mm at each end of the stand.

Note: Where multiple stands are to be accommodated, then access to battery room will need to be at one end in order to access each gangway. In this case, a minimum space of 600mm at the access end of the battery stand should be allowed.

Battery Room Layout

d) Examples

1. One stand located against wall

PowerSafe® V

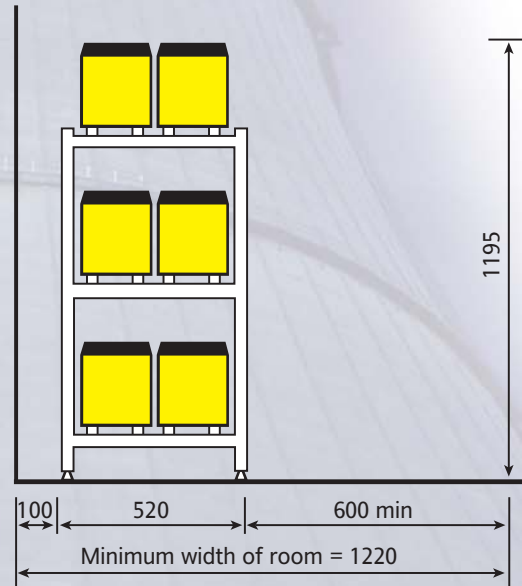
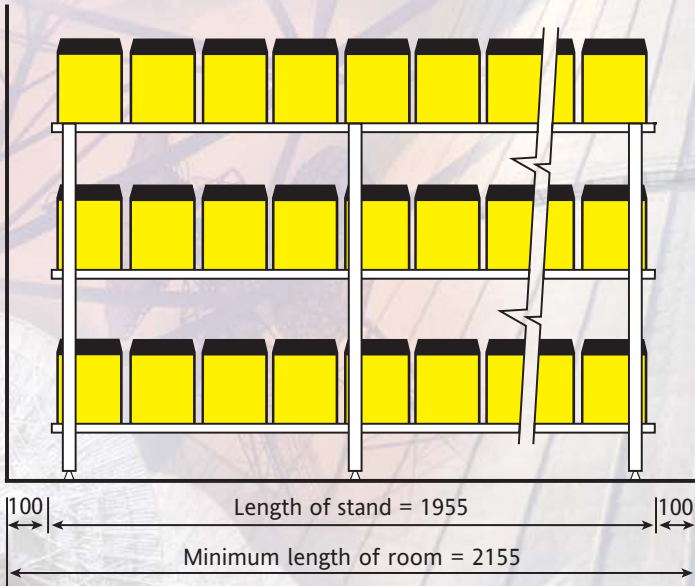

PowerSafe® V Front Terminal

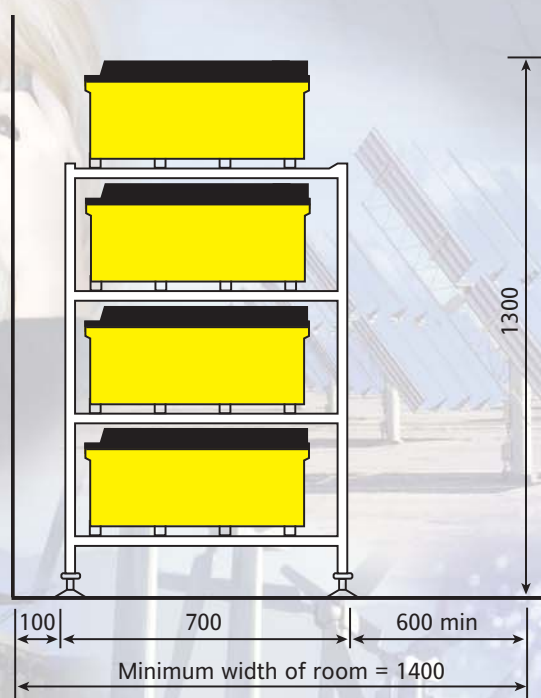
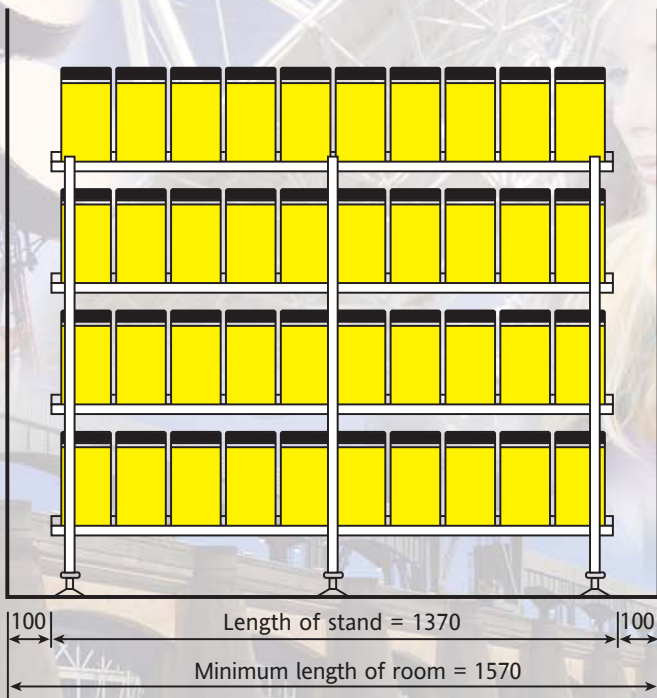

2. Two stands located against side walls

PowerSafe® V & V Front Terminal

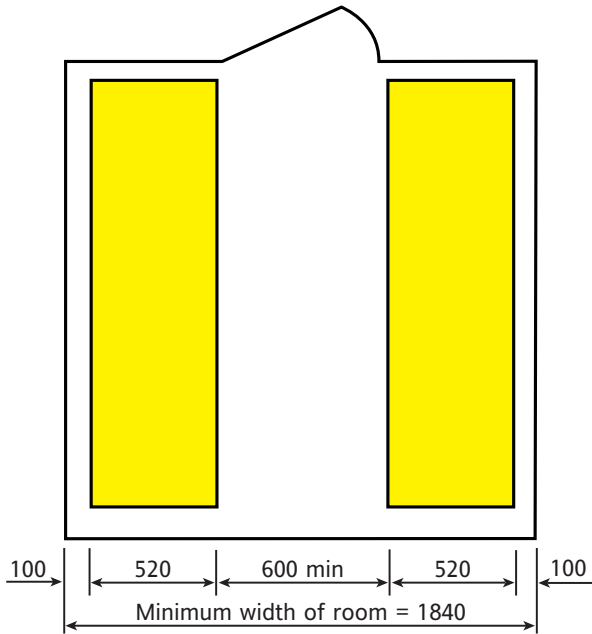

3. Multiple Stands in room

PowerSafe® V & V Front Terminal

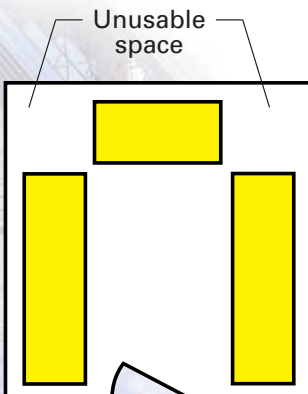
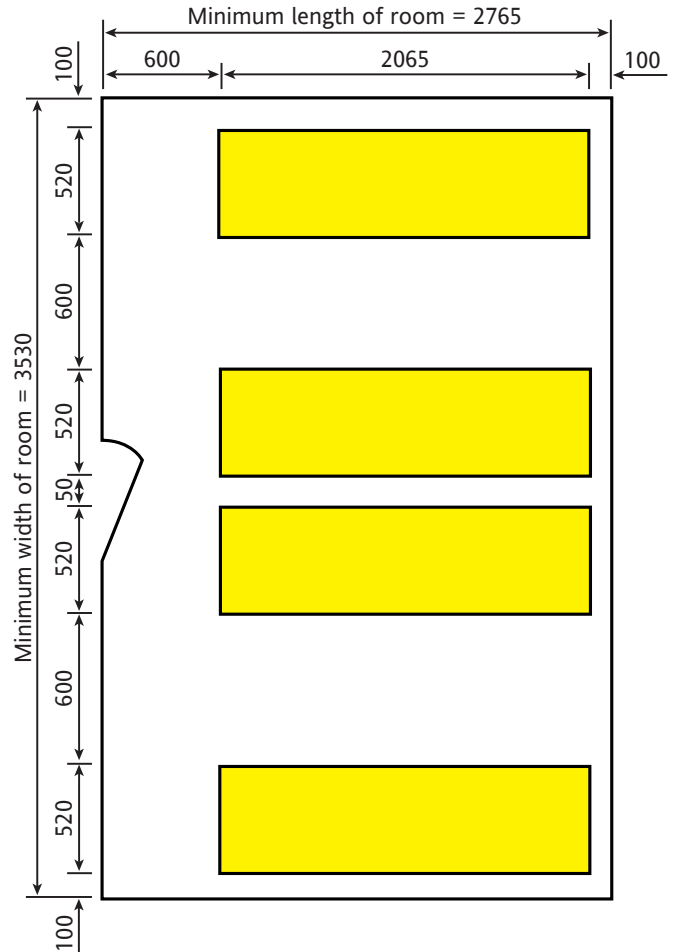

Note: Unusable Space

Where battery accommodation space is restricted to the extent that it is necessary to locate the battery around 2 (or 3) adjacent walls of the room, the corner space should not be used so that access to all the cells of the battery is available.

PowerSafe® V General Specifications

Battery Type	Number of Cells	Nominal Voltage (V)	Nominal Capacity (Ah)		Nominal Dimensions			Typical Weight kg	Short Circuit Current (A) ⁽²⁾	Internal Resistance (mΩ) ⁽²⁾	Terminals
			10 hr rate to 1.80Vpc @ 20°C	8 hr rate to 1.75Vpc @ 77°F	Length mm	Width ⁽¹⁾ mm	Overall Height mm				
12V45	6	12	46	47	218	164	224	18.9	1783	6.94	M6 Female
12V55	6	12	56	59	271	164	224	22.9	1962	6.31	M6 Female
12V70	6	12	68	70	314	164	224	26.7	2440	5.07	M6 Female
12V80	6	12	79	82	360	164	229	31.5	2717	4.55	M6 Female
4V105	2	4	103	103	191	202	235	16.5	2740	1.51	M8 Male
6V105	3	6	103	103	191	202	235	22.0	2740	2.26	M8 Male
6V130	3	6	132	134	243	206	242	27.9	4348	1.43	M8 Female
4V155	2	4	154	155	202	202	228	23.0	4800	0.80	M8 Male
6V155	3	6	154	155	292	202	228	33.0	4800	1.20	M8 Male
6V170	3	6	173	173	302	175	256	34.0	3814	1.62	M8 Female
2V200	1	2	200	194	110	208	269	13.9	5295	0.39	M8 Female
4V230	2	4	231	232	292	202	228	32.5	6082	0.68	M8 Male
2V275	1	2	275	267	142	208	269	18.5	6596	0.32	M8 Female
2V310	1	2	308	309	202	202	228	23.0	9259	0.22	M8 Male
2V320	1	2	320	329	195	208	245	22.0	9675	0.22	M8 Female
2V400/2	1	2	400	388	195	208	270	26.2	8836	0.24	M8 Female
2V460/4	1	2	462	464	292	202	228	32.5	10929	0.18	M8 Male
2V460/6	1	2	462	464	292	202	228	33.0	10929	0.18	M8 Male
2V500/2	1	2	500	484	238	208	269	32.5	9237	0.22	M8 Female
2V500/6	1	2	518	516	296	204	240	34.7	14857	0.14	M8 Female
12V30F	6	12	31	31	280	97	159	10.8	1327	9.87	M8 Female
12V38F	6	12	38	38	280	97	184	12.5	1500	8.53	M8 Female
12V62F	6	12	62	62	280	97	264	19.7	2100	5.87	M8 Female
12V92F	6	12	92	92	395	105	264	28.0	2500	5.05	M8 Female
12V100FC	6	12	100	100	395	108	287	30.8	1900	6.60	M8 Female
12V101F	6	12	100	101	510	110	235	33.5	2108	5.92	M8 Female
12V125F	6	12	125	126	561	105	316	46.5	2223	5.49	M6 Male
12V155FS	6	12	150	155	561	125	283	50.0	2790	4.44	M6 Male
12V170FS	6	12	170	170	561	125	283	50.5	2950	4.30	M6 Male
12V170F	6	12	170	170	561	125	316	60.0	3131	3.94	M6 Male
12V190F	6	12	190	190	561	125	316	57.3	3625	3.50	M6 Male

Notes:

⁽¹⁾ In horizontal installation, the width of PowerSafe V top terminal blocs becomes the height, irrespective of positive and negative polarities.

⁽²⁾ Figures obtained via IEC method.

EnerSys

P.O. Box 14145
Reading, PA 19612-4145
USA
Tel: +1-610-208-1991
+1-800-538-3627
Fax: +1-610-372-8613

EnerSys Europe

Löwenstrasse 32
8001 Zurich
Switzerland

EnerSys Asia

152 Beach Road
Gateway East Building
Level 11
189721 Singapore
Tel. +65 6508 1780

EnerSys Ltd.

Oak Court
Clifton Business Park
Wynne Avenue
Swinton
Manchester M27 8FF
UK
Tel: +44 (0)161 794 4611
Fax: +44 (0)161 727 3809

Contact:

© 2011 EnerSys. All rights reserved.
Trademarks and logos are the property of EnerSys and its affiliates unless otherwise noted.



www.enersys-emea.com