

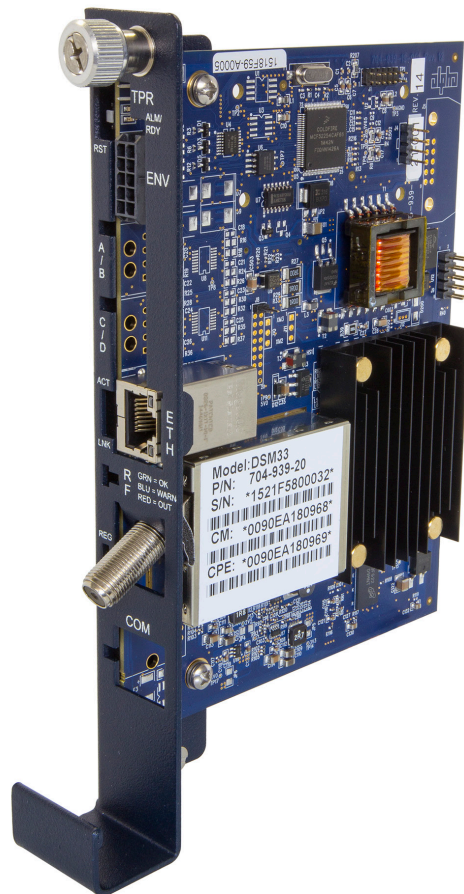

# AlphaNet™ DM3.0 Series DOCSIS® Status Monitor for XM3 Technical Manual

Effective: January 2017



## Safety Notes

Alpha considers customer safety and satisfaction its most important priority. To reduce the risk of injury or death and to ensure continual safe operation of this product, certain information is presented differently in this manual. Alpha tries to adhere to ANSI Z535 and encourages special attention and care to information presented in the following manner:



### **WARNING! GENERAL HAZARD**

GENERAL HAZARD WARNING provides safety information to PREVENT INJURY OR DEATH to the technician or user.



### **WARNING! ELECTRICAL HAZARD**

ELECTRICAL HAZARD WARNING provides electrical safety information to PREVENT INJURY OR DEATH to the technician or user.



### **WARNING! FUMES HAZARD**

FUMES HAZARD WARNING provides fumes safety information to PREVENT INJURY OR DEATH to the technician or user.



### **WARNING! FIRE HAZARD**

FIRE HAZARD WARNING provides flammability safety information to PREVENT INJURY OR DEATH to the technician or user.

There may be multiple warnings associated with the call out. Example:



### **WARNING! ELECTRICAL & FIRE HAZARD**

This WARNING provides safety information for both Electrical AND Fire Hazards



### **CAUTION!**

CAUTION provides safety information intended to PREVENT DAMAGE to material or equipment.



### **NOTICE:**

NOTICE provides additional information to help complete a specific task or procedure.

### **ATTENTION:**

ATTENTION provides specific regulatory/code requirements that may affect the placement of equipment and /or installation procedures.

The following sections contain important safety information that must be followed during the installation and maintenance of the equipment and batteries. Read all of the instructions before installing or operating the equipment, and save this manual for future reference.

# AlphaNet™ DM3.0 Series DOCSIS® Status Monitor for XM3

## Technical Manual

704-939-B0-001 Rev. A2

Effective Date: January 2017

© 2017 by Alpha Technologies, Inc.

member of The  Group™

## Disclaimer

Images contained in this manual are for illustrative purposes only. These images may not match your installation.

Operator is cautioned to review the drawings and illustrations contained in this manual before proceeding. If there are questions regarding the safe operation of this powering system, please contact Alpha Technologies or your nearest Alpha representative.

Alpha shall not be held liable for any damage or injury involving its enclosures, power supplies, generators, batteries or other hardware if used or operated in any manner or subject to any condition not consistent with its intended purpose or is installed or operated in an unapproved manner or improperly maintained.

## Contact Information

Sales information and customer service in USA  
(7AM to 5PM, Pacific Time):

1 800 322 5742

Complete technical support in USA  
(7AM to 5PM, Pacific Time or 24/7 emergency support):

1 800 863 3364

Sales information and technical support in Canada:

1 888 462 7487

Website:

[www.alpha.com](http://www.alpha.com)

# Table of Contents

|  |    |
|--|----|
| 1.0 Introduction . . . . .   | 8  |
| 2.0 Overview . . . . .   | 10 |
| 2.1 System Diagram . . . . .   | 10 |
| 2.2 Network Connectivity . . . . .   | 11 |
| 2.3 System Configuration and Installation . . . . .                                  | 11 |
| 2.4 DM3.0 Series Start Up and Reboot Routine . . . . .                               | 12 |
| 3.0 Network Configuration . . . . .  | 13 |
| 3.1 Provisioning the DHCP Server with the MAC Addresses . . . . .                    | 13 |
| 3.2 Establishing IP Connectivity . . . . .   | 14 |
| 3.3 The DOCSIS Configuration File . . . . .  | 14 |
| 3.3.1 Setting Modem Community Strings - docsDevNmAccess Method (IPv4 Only) . . . . . | 15 |
| 3.3.2 Setting Modem Community Strings - Coexistence Method . . . . .                 | 16 |
| 3.3.3 Setting SNMP Trap Destination Addresses - docsDevNmAccess Method . . . . .     | 17 |
| 3.3.4 Setting SNMP Trap Destination Addresses - Coexistence Method . . . . .         | 18 |
| 3.3.5 Sample DOCSIS Configuration File Entries - docsDevNmAccess Method . . . . .    | 19 |
| 3.3.6 Sample DOCSIS Configuration File Entries - Coexistence Method . . . . .        | 20 |
| 3.3.7 Proprietary Configuration File 'atidoc33.cfg' . . . . .                        | 21 |
| 3.3.8 Changing Default atidoc33.cfg Download Settings . . . . .                      | 22 |
| 3.4 Setting Communication Options . . . . .  | 23 |
| 4.0 Web Interface . . . . .  | 24 |
| 4.1 Local Web Server Access . . . . .  | 24 |
| 4.2 Remote Web Server Access . . . . .   | 27 |
| 4.3 Navigating the Web Page . . . . .  | 28 |
| 4.3.1 Web Interface Security Levels . . . . .  | 29 |
| 4.4 Verifying Communication Parameters . . . . .                                     | 30 |
| 4.5 Verifying Power Supply and Battery Parameters . . . . .                          | 31 |
| 4.6 Remote Self Tests via the Web Page . . . . .                                     | 31 |
| 4.7 Viewing HMS Alarm Status via the Web Page . . . . .                              | 32 |
| 4.8 Setting the I/O Controller via the Web Page . . . . .                            | 33 |
| 4.9 Viewing and Configuring Power Supply Settings via the Web Page . . . . .         | 34 |
| 4.10 Viewing and Configuring Generator Settings Via the Web Page . . . . .           | 37 |
| 4.11 Tools Menu - Constellation, Microreflections, and Spectrum . . . . .            | 38 |
| 4.11.1 QAM Constellation Tool . . . . .  | 38 |
| 4.11.2 QAM Constellation Common Impairments . . . . .                                | 39 |
| 4.11.3 Microreflections Tool . . . . .   | 44 |
| 4.11.4 Spectrum Tool . . . . .   | 45 |
| 4.12 Viewing AlphaApps Information via the Web Page . . . . .                        | 47 |
| 4.13 Battery Management . . . . .  | 48 |
| 4.14 Viewing Power Supply Event and Configuration Logs . . . . .                     | 50 |
| 4.15 Battery Event Log . . . . .   | 54 |
| 4.16 Viewing the Modem Event Log via the Web Page . . . . .                          | 54 |
| 5.0 Upgrading Firmware . . . . .   | 55 |
| 5.1 Upgrading DM3.0 Series Transponder Modem Firmware . . . . .                      | 55 |
| 5.1.1 Identifying the Modem and Obtaining Firmware Files . . . . .                   | 55 |
| 5.1.2 Modem Firmware Upgrade SNMP Parameters . . . . .                               | 55 |
| 5.1.3 Upgrading Manually by Setting SNMP Parameters . . . . .                        | 56 |
| 5.1.4 Upgrading via the DOCSIS Configuration File . . . . .                          | 56 |
| 6.0 Data Management . . . . .  | 57 |
| 6.1 SCTE-HMS MIBs . . . . .  | 57 |

# Table of Contents

|  |     |
|--|-----|
| 6.2 SCTE-HMS MIB Alarms . . . . .  | 58  |
| 6.2.1 SCTE-HMS Configurable Alarms. . . . .                              | 58  |
| 6.2.2 SNMP Traps . . . . .   | 65  |
| 6.2.3 General Power Supply Alarms . . . . .                              | 67  |
| 6.2.4 Battery Alarms . . . . .   | 69  |
| 7.0 Installation . . . . .   | 70  |
| 7.1 Verifying Power Supply Device Address . . . . .                      | 70  |
| 7.2 Installation / Replacement Procedure in XM3 Power Supplies . . . . . | 71  |
| 7.3 DM3 LEDs and Connections . . . . .                                   | 73  |
| 7.4 DM3X LEDs and Connections . . . . .                                  | 74  |
| 7.5 Connecting the RF Drop . . . . .                                     | 75  |
| 7.6 Front Panel Connections . . . . .                                    | 75  |
| 7.7 I/O Connections (TPR, ENV). . . . .                                  | 76  |
| 7.7.1 Tamper (TPR) Switch Interface. . . . .                             | 76  |
| 7.7.2 I/O Port Interface . . . . .                                       | 77  |
| 7.7.3 Configuring I/O Port Connections . . . . .                         | 77  |
| 7.7.4 I/O Port: Generic Device . . . . .                                 | 78  |
| 7.7.5 Connecting a Generic I/O Device . . . . .                          | 79  |
| 7.7.6 Configuring and Monitoring a Generic I/O Device . . . . .          | 79  |
| 7.7.7 I/O Port: Heater Mat Control . . . . .                             | 80  |
| 7.7.8 Connecting the Battery Heater Mat Controller . . . . .             | 81  |
| 7.7.9 Configuring the Battery Heater Mat Controller . . . . .            | 82  |
| 7.7.10 I/O Port: Emergency DC Generator (GEN) . . . . .                  | 82  |
| 7.7.11 Configuring and Monitoring the DC Emergency Generator . . . . .   | 83  |
| 8.0 Battery Sense Wire Kits . . . . .                                    | 84  |
| 8.1 36V Single and Dual Strings . . . . .                                | 84  |
| 9.0 Start Up and Verification . . . . .                                  | 85  |
| 9.1 Initial Start Up and Local Verification. . . . .                     | 85  |
| 9.2 Verifying Correct Hardware Interconnection . . . . .                 | 87  |
| 9.3 System Status Indicators and Reset Button . . . . .                  | 88  |
| 9.3.1 Detailed LED Descriptions . . . . .                                | 89  |
| 9.3.2 Resetting the Transponder . . . . .                                | 92  |
| 9.4 Verifying Communications via the Headend . . . . .                   | 92  |
| 9.5 Dual IP Mode. . . . .  | 93  |
| 9.5.1 Overview . . . . .   | 93  |
| 9.5.2 Web Comparison, Single IP Mode/Dual IP Mode . . . . .              | 94  |
| 9.5.3 Configuring Dual IP Mode . . . . .                                 | 95  |
| 9.5.4 Dual IP SNMP Community Strings . . . . .                           | 98  |
| 9.5.6 Security in Dual IP Mode . . . . .                                 | 99  |
| 10.0 Specifications . . . . .  | 101 |
| 11.0 Glossary. . . . .   | 103 |
| 11.1 Acronym Definitions. . . . .  | 103 |

# Figures

|   |    |
|---|----|
| Fig. 1-1, AlphaNet DM3X(EX)   | 8  |
| Fig. 1-2, AlphaNet DM3(E)   | 8  |
| Fig. 1-3, DM3.0 Series Transponder Components (DM3X Model Shown).                       | 9  |
| Fig. 2-1, Representative System Arrangement.  | 10 |
| Fig. 2-2, DM3.0 Series Transponder Start Up and Reboot Routine                          | 12 |
| Fig. 3-1, Locations of MAC Address Labels   | 13 |
| Fig. 4-1, DM3.0 Series Transponder Web Page   | 24 |
| Fig. 4-2, Local Area Connection Properties Screen, Windows® 7                           | 25 |
| Fig. 4-3, Internet Protocol (TCP/IP) Properties Screen, Windows® 7                      | 25 |
| Fig. 4-4, Local Area Connection Properties Screen, Windows® 8                           | 26 |
| Fig. 4-5, Internet Protocol (TCP/IP) Properties Screen, Windows® 8                      | 26 |
| Fig. 4-6, Web Server Home Page  | 27 |
| Fig. 4-7, Navigation Bar Items  | 28 |
| Fig. 4-8, Communication Parameters  | 30 |
| Fig. 4-9, Advanced Communication Parameters   | 30 |
| Fig. 4-10, Power Supply and Battery Parameters  | 31 |
| Fig. 4-11, HMS Alarm Configuration  | 32 |
| Fig. 4-12, HMS Alarm Configuration - Export Settings                                    | 32 |
| Fig. 4-13, Advanced I/O Controller Status Screen  | 33 |
| Fig. 4-14, Advanced Power Supply Settings Screen  | 34 |
| Fig. 4-15, Advanced Generator Status Screen   | 37 |
| Fig. 4-16, QAM Constellation Tool   | 38 |
| Fig. 4-17, Normal - (Good Quality) and Individual Cell Characteristics                  | 39 |
| Fig. 4-18, Fuzzy (Low CNR and/or Low MER) and Individual Cell Characteristics           | 40 |
| Fig. 4-19, Doughnuts (Coherent Interference) and Individual Cell Characteristics        | 40 |
| Fig. 4-20, Gaussian Noise and Individual Cell Characteristics                           | 41 |
| Fig. 4-21, Rectangular vs. Square (I-Q Imbalance) and Entire Constellation Shape        | 41 |
| Fig. 4-22, Corners Squeezed to Center (Gain Compression) and Entire Constellation Shape | 42 |
| Fig. 4-23, Circular Smear (Phase Noise) and Entire Constellation Shape                  | 42 |
| Fig. 4-24, Twisted or Skewed (Quadrature Distortion) and Entire Constellation Shape     | 43 |
| Fig. 4-25, Microreflections Tool  | 44 |
| Fig. 4-26, Spectrum Tool  | 45 |
| Fig. 4-27, Spectrum Tables  | 46 |
| Fig. 4-28, AlphaApps and Utility Status Parameters                                      | 47 |
| Fig. 4-29, Battery Management   | 48 |
| Fig. 4-30, Battery Model Selection  | 49 |
| Fig. 4-31, System Log   | 50 |
| Fig. 4-32, Power Supply Event Log   | 52 |
| Fig. 4-33, Power Supply Configuration Log   | 53 |
| Fig. 4-34, Battery Event Log  | 54 |
| Fig. 4-35, Docsdev Event Log Screen   | 54 |
| Fig. 7-1, Captive Screw Locations   | 71 |
| Fig. 7-2, Jumper Location and the 18-Pin Connector                                      | 72 |
| Fig. 7-3, Connecting the Transponder to the Inverter Module                             | 72 |
| Fig. 7-4, DM3 LEDs and Connectors   | 73 |
| Fig. 7-5, DM3X LEDs and Connectors  | 74 |
| Fig. 7-6, Connecting the RF Drop  | 75 |
| Fig. 7-7, System Interconnection Diagram  | 75 |
| Fig. 7-8 I/O (ENV) and Tamper Switch Interface (TPR) Connection Locations               | 76 |
| Fig. 8-1 36V System, Single String  | 84 |
| Fig. 8-2, 36V System, Dual String   | 84 |
| Fig. 9-1, XM3 Smart Display Screens   | 85 |
| Fig. 9-2, Communications Section - General Page   | 86 |

# Figures

|  |    |
|--|----|
| Fig. 9-3, Power Supply Section - General Page . . . . .                                | 87 |
| Fig. 9-4, LED Functionality and Indications . . . . .                                  | 88 |
| Fig. 9-5, Transponder Web Page, RF Power Level Indicators . . . . .                    | 91 |
| Fig. 9-6, Simplified Block Diagram Single IP Mode . . . . .                            | 93 |
| Fig. 9-7, Simplified Block Diagram Dual IP Mode . . . . .                              | 93 |
| Fig. 9-8, Single IP DM3.0 Series Transponder Web Page . . . . .                        | 94 |
| Fig. 9-9, Dual IP DM3.0 Series Transponder Web Page . . . . .                          | 94 |
| Fig. 9-10, Dual IP Configuration Settings for Web Server Communications Page . . . . . | 96 |
| Fig. 9-11, Dual IP Parameters for Web Server General Page . . . . .                    | 96 |

# Tables

|  |     |
|--|-----|
| Table 1-1, DM3.0 Series Transponder Model Specifications . . . . .                   | 8   |
| Table 2-1, LEDs and Indications . . . . .  | 12  |
| Table 3-1, Modem Community String Parameters - docsDevNmAccess Method . . . . .      | 15  |
| Table 3-2, Modem Community String Parameters - Coexistence Method . . . . .          | 16  |
| Table 3-3, Trap Destination Addresses - docsDevNmAccess Method . . . . .             | 17  |
| Table 3-4, Trap Destination Addresses - docsDevNmAccess Method . . . . .             | 18  |
| Table 3-5, Default atidoc33.cfg Download Settings . . . . .                          | 22  |
| Table 3-6, Communications Parameters . . . . .                                       | 23  |
| Table 4-1, DM3.0 Series Transponder Web Page Security . . . . .                      | 29  |
| Table 4-2, DM3.0 Series Transponder Security Levels . . . . .                        | 29  |
| Table 4-3, Spectrum Tool Buttons . . . . .   | 45  |
| Table 4-4, Spectrum Table Details . . . . .  | 46  |
| Table 4-5, Time Offset Values and Location References (offset +/- GMT) . . . . .     | 51  |
| Table 5-1, Modem Firmware Upgrade SNMP Parameters . . . . .                          | 55  |
| Table 5-2, SNMP Parameters . . . . .   | 56  |
| Table 5-3, DOCSIS Configurations File Values . . . . .                               | 56  |
| Table 6-1, SCTE-HMS MIB Files . . . . .  | 57  |
| Table 6-2, Binary to Hex Conversions for Alarm Settings . . . . .                    | 59  |
| Table 6-3, Recommended Settings for DM3.0 Series Transponder Analog Alarms . . . . . | 60  |
| Table 6-4, Recommended Settings for Discrete Alarms . . . . .                        | 61  |
| Table 6-5, DM3.0 Series Transponder Alarm Setting Parameters . . . . .               | 64  |
| Table 6-6, Status of Alarm Setting Download Parameters . . . . .                     | 64  |
| Table 6-7, SNMP Alarm Trap Varbinds and Explanations . . . . .                       | 66  |
| Table 6-8, Power Alarms: Classifications, Causes and Corrections . . . . .           | 68  |
| Table 6-9, Battery Alarms: Classifications, Causes and Corrections . . . . .         | 69  |
| Table 7-1, Tamper (TPR) Switch Specifications . . . . .                              | 76  |
| Table 7-2, ENV Connector and Pin Descriptions . . . . .                              | 77  |
| Table 7-3, I/O Port Specifications . . . . .   | 78  |
| Table 7-4, I/O Port: Generic Device Specifications . . . . .                         | 78  |
| Table 7-5, I/O Port: Heater Mat Control Specifications . . . . .                     | 80  |
| Table 7-6, Heater Mat OIDs and Functionality . . . . .                               | 82  |
| Table 7-7, Heater Mat MIB Reports . . . . .  | 82  |
| Table 7-8, Generator Monitoring Values . . . . .                                     | 83  |
| Table 9-1, SCTE-HMS Property Table . . . . .   | 90  |
| Table 9-2, Rx/Tx Power LED Color Ranges . . . . .                                    | 90  |
| Table 9-3, Single IP Mode vs. Dual IP Mode . . . . .                                 | 93  |
| Table 9-4, Enabling Dual IP Mode . . . . .   | 95  |
| Table 9-5, CPE Communications Module IP Settings . . . . .                           | 95  |
| Table 9-6, Available Download Options . . . . .                                      | 97  |
| Table 9-7, Community Strings . . . . .   | 98  |
| Table 9-8, Data Access Key Parameters . . . . .                                      | 99  |
| Table 9-9, Secure Access Table Parameters . . . . .                                  | 100 |

# 1.0 Introduction

The AlphaNet DM3.0 Series Embedded DOCSIS and EuroDOCSIS Transponders allow monitoring of Alpha power supplies through existing cable network infrastructure. Advanced networking services provide quick reporting and access to critical powering information. This manual focuses on the four models of the DM3.0 Series Transponder complementing the XM3-HP CableUPS.

The DM3.0 Series Transponder utilizes Simple Network Management Protocol (SNMP) and Management Information Bases (MIBs) to provide network status monitoring and diagnostics. A Web interface enables authorized personnel direct access to advanced diagnostics using a common Web browser. No custom software is required. See Table 1-1 for model specifications.

| DM3.0 Series Transponder Model Specifications |            |                            |            |                            |
|---|------------|----------------------------|------------|----------------------------|
| Features & Information                        | DM3        | DM3EX                      | DM3E       | DM3X                       |
| Part Number                                   | 704-939-21 | 704-939-22                 | 704-939-23 | 704-939-20                 |
| 1 & 2 Battery Strings                         | No         | Yes                        | No         | Yes                        |
| 3 & 4 Battery Strings                         | No         | Yes                        | No         | Yes                        |
| DOCSIS 3.0 Standard                           | U.S.       | EURO                       | EURO       | U.S.                       |
| Gb-Ethernet, CPE and local access             | Yes        | Yes                        | Yes        | Yes                        |
| Tamper Switch Interface                       | Yes        | Yes                        | Yes        | Yes                        |
| ENV I/O Monitoring and Control                | Yes        | Yes                        | Yes        | Yes                        |
| COM Port (AlphaBus) (PSx5 & AlphaGen)         | No         | Yes                        | No         | Yes                        |
| Battery Monitoring                            | Indirect   | 24V / 36V x 4 STR / 6 x 6V | Indirect   | 24V / 36V x 4 STR / 6 x 6V |
| Quality of Service (QoS)                      | Yes        | Yes                        | Yes        | Yes                        |

Table 1-1, DM3.0 Series Transponder Model Specifications

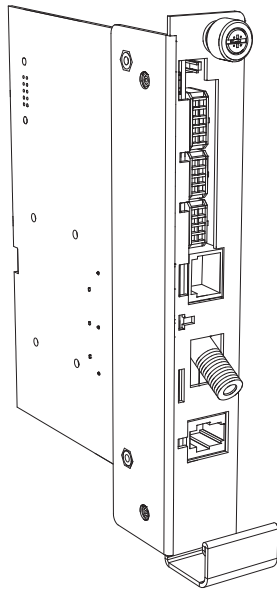

Fig. 1-1, AlphaNet DM3X(EX)

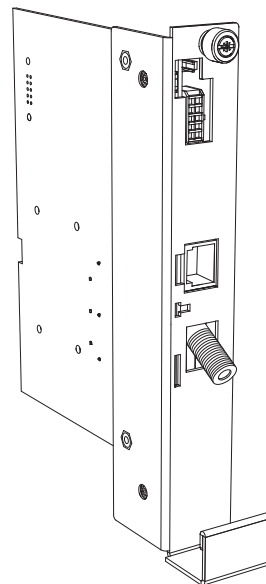

Fig. 1-2, AlphaNet DM3(E)



## 1.0 Introduction, continued

### Primary Features

- DOCSIS 3.0 “Full Band Capture” hardware
- 10/100/1000 Mbps auto-negotiating standard Ethernet interface
- Local Ethernet port provides technician on-site access to extensive power supply diagnostics\*
- Embedded Web server for direct diagnostics
- Supports SNMPv1, v2c, v3
- Extensive power supply diagnostic MIBs
- Environmentally hardened DOCSIS cable modem and transponder
- Angled RF connector reduces cable bend radius
- Diagnostic LEDs
- North American or Euro DOCSIS available

\*Ethernet port also permits the connecting of external CPE devices.

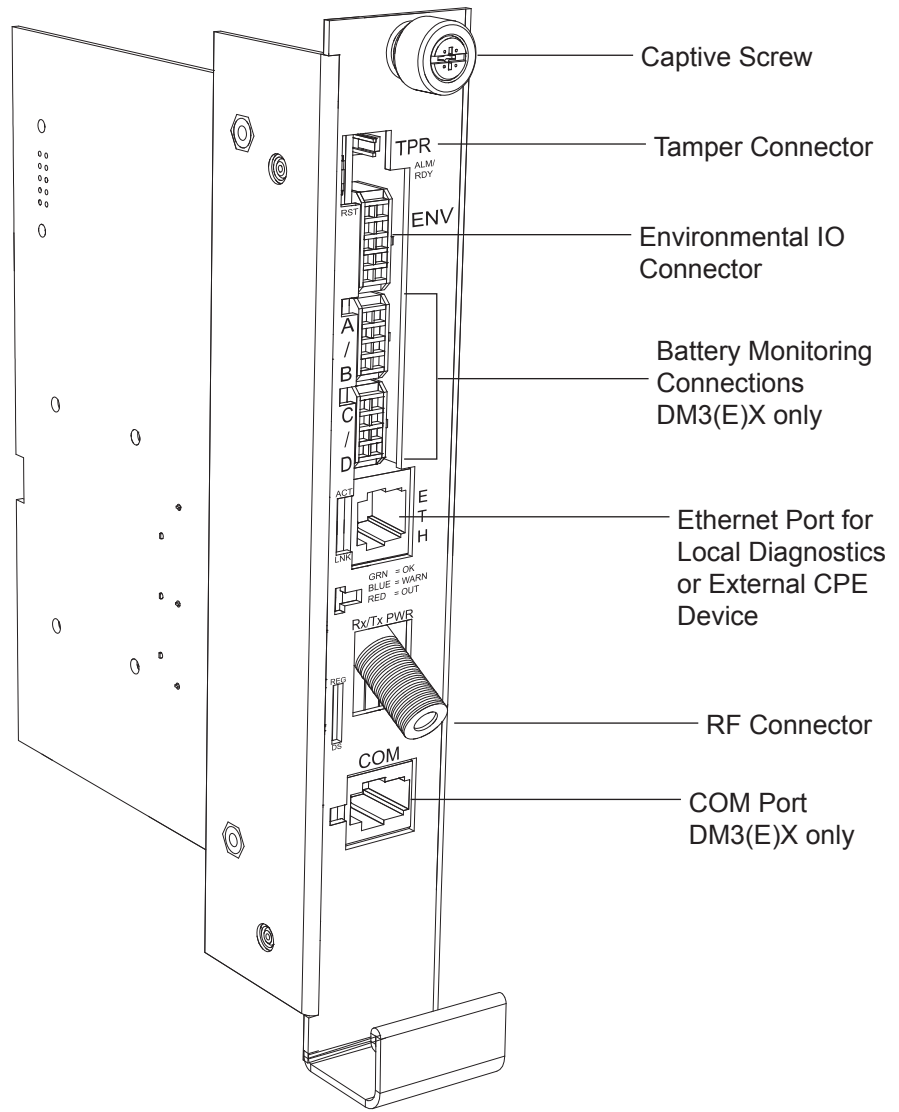

**Fig. 1-3, DM3.0 Series Transponder Components (DM3X Model Shown)**

## 2.0 Overview

### 2.1 System Diagram

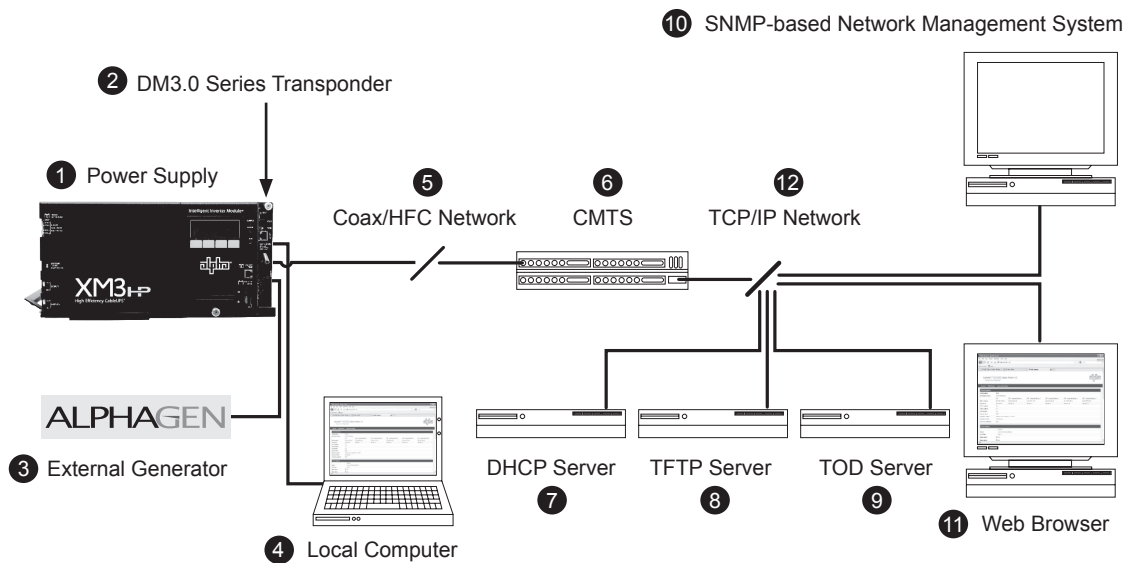

**Fig. 2-1, Representative System Arrangement**

- 1 All power supply data is stored in the power supply Inverter Module's class information base (CIB) tables in the power supply. This data is accessible directly via the power supply's Smart Display (see the power supply's technical manual for details). The CIB tables are the source of the transponder's data.
- 2 The DM3.0 Series Transponder contains both SCTE-HMS Management Information Base (MIBs) and the proprietary Alpha MIB tables. The SCTE-HMS MIBs are industry standard MIB tables that store power supply, battery and generator data from the CIB tables (DM3X only) (See Section 6.0, Data Management). The Alpha MIB contains all the data of the SCTE-HMS MIBs plus additional power supply settings and values as well as the transponder's configuration values.
- 3 An external generator or additional power supplies may be connected through the COM (AlphaBus) port permitting monitoring locally through the Ethernet connector or remotely via the Web page or SNMP-based Network Management System (DM3X only).
- 4 Power supply and transponder parameters can be monitored and set locally using a laptop and a standard Ethernet cable.
- 5 The transponder transmits data via its cable modem directly over the Coax or Hybrid Fiber Coax network.
- 6 The Cable Modem Termination System (CMTS) is the bridge between the cable network and the TCP/IP network. The transponder's cable modem communicates over the HFC network to the CMTS.
- 7 The Dynamic Host Control Protocol (DHCP) server needs to be provisioned with the transponder's cable modem CM MAC address and the MAC address needs to be assigned a DOCSIS Configuration File.
- 8 The DOCSIS Configuration File and firmware files should be available in the Root Directory of the Trivial File Transfer Protocol (TFTP) Server.
- 9 The Time of Day (TOD) Server provides the cable modem with the current date and time.
- 10 A Network Management System (NMS) or MIB Browser allows remote monitoring, control, and configuration of the transponder, power supply and connected device parameters. Alarms and traps can be set and monitored.
- 11 The power supply and generator data may be accessed remotely through the transponder's Web page by placing its IP address into a standard Web browser.
- 12 The following ports of the Transmission Control Protocol/Internet Protocol network must be opened: 161=SNMP, 162=SNMP, Traps, 69=TFTP, 80=HTTP.

## 2.0 Overview, continued

### 2.2 Network Connectivity

The transponder's cable modem must be provisioned to be recognized by the CMTS as a valid device to be assigned an IP address from the DHCP server with the correct options to locate the TFTP and TOD servers and to communicate with the SNMP management server (trap receiver). The DM3.0 Series Transponder must be provisioned in the cable system to allow it to be recognized by the CMTS, receive an IP address, TOD, TFTP files and communicate with the SNMP management system.

In single IP-configured devices, data from both the cable modem and power supply are accessed and managed through the modem's IP address on the secure private modem network. The transponder is not accessible from the public Customer Premises Equipment (CPE) network. Consequently, the Network Management System (NMS) that monitors the power supplies must have access to the same private modem network.

CMTS and system vendors use different security methods to insure network integrity, but common considerations are:

- Network MAC filtering may have to be modified to allow the cable modem OUI of 00:90:EA for North America, and 00:03:08 for European models.
- For SNMP access, UDP ports 161 and 162 must not be blocked.
- For TFTP access, port 69 must not be blocked.
- For HTTP access, port 80 must not be blocked.
- For TOD access, port 37 must not be blocked.
- Firewalls must allow TFTP, DHCP, SNMP and TOD communication to the cable modem.
- If the address of the TFTP or TOD server is different than the DHCP server, the response from the DHCP server must contain the TFTP and TOD addresses.

### 2.3 System Configuration and Installation



#### **NOTICE:**

---

Before installation, read all of **Section 2.0, Overview**.

DM3.0 Series Transponder installation and setup is comprised of three basic steps:

1. **Configuring the Network:** Provisioning the DHCP Server with the transponder's MAC address and assigning it a DOCSIS Configuration File.
2. **Setting Options:** The DM3.0 Series Transponder is designed for out-of-the-box, "plug and play" operation, but non-default settings such as SNMP trap destination addresses may be required for the Network Management System (NMS). SNMP trap addresses can be set automatically via the DOCSIS Configuration File per RFC 4639 (IPv4), or through SNMPv3 Notification settings (IPv6), while proprietary options may be set through type-11 TLV entries.
3. **Field Installation of the DM3.0 Series Transponder** into the power supply, connecting the battery string wire harnesses, Tamper, and Environmental Control (as applicable) and verifying operation.

These steps can be performed independently of one another. However, configuring the network prior to field installation will allow the installation to be verified while personnel are still on-site. Performing field installation before network configuration and before the installation can be verified, might result in additional field service calls to correct mistakes.

Carefully read the following section in order to understand the dependencies within the system before performing system configuration or hardware installation.

## 2.4 DM3.0 Series Start Up and Reboot Routine

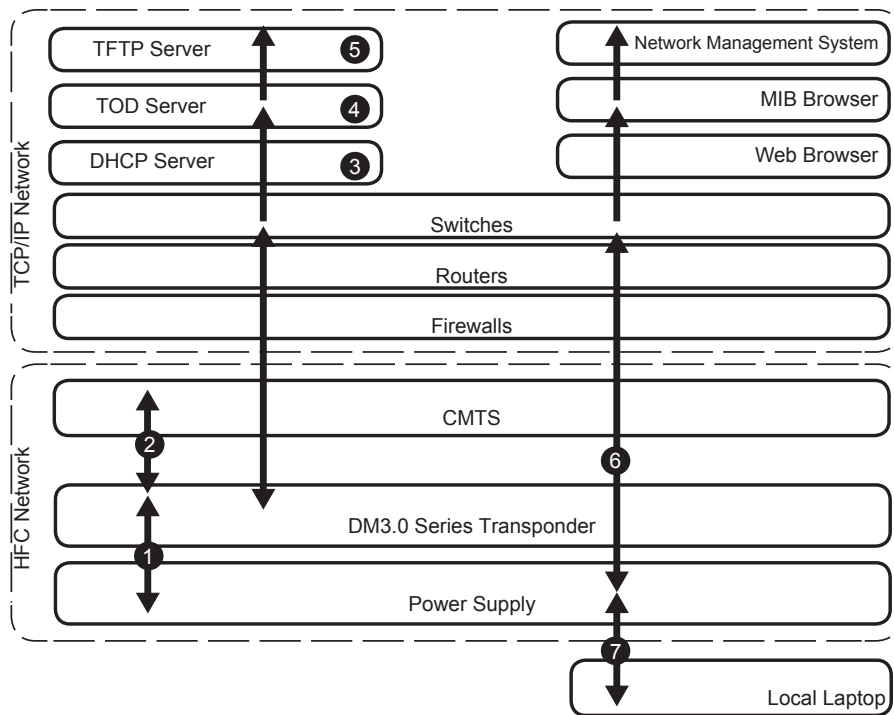

**Fig. 2-2, DM3.0 Series Transponder Start Up and Reboot Routine**

The above diagram, read left to right, indicates the order of operations as the transponder comes online. There are certain conditions that must exist for each step to occur, resulting in successful data monitoring and management. The numbers below correspond to the numbered arrows above.

- Blue Rx/Tx Power LED indicates Rx/Tx Power at a warning level. Make the necessary RF level adjustments.
- Red Rx/Tx Power LED indicates Rx/Tx Power at an alert level. Make the necessary RF level adjustments.

| LEDs and Indications |   |                  |                 |               |               |                                      |  |            |
|----------------------|---|------------------|-----------------|---------------|---------------|--------------------------------------|--|------------|
| Ref #                | Communications State  | ALM/ RDY         | Downstream (DS) | Upstream (US) | Rx / Tx Power | ONLINE (OL)                          | Communications (COM)                                 | Link (LNK) |
| 1                    | Transponder Initializing / Searching for Downstream DOCSIS channel                  | Flashing (Green) | Flashing        | OFF           | OFF           | OFF                                  | OFF  | OFF        |
| 2                    | Downstream channel acquired, service group determination and ranging initialization | Flashing (Green) | ON              | Flashing      | OFF           | OFF                                  | OFF  | OFF        |
| 3 - 5                | Online - registration complete  | Flashing (Green) | ON              | ON            | ON (Green)    | ON                                   | OFF and ON   | OFF        |
| 6                    | DM3.0 Series Transponder fully functional   | Flashing (Green) | ON              | ON            | ON (Green)    | ON                                   | Bursts when communicating to multiple power supplies | OFF        |
| 7                    | Laptop Connected (Local)  | Flashing (Green) | ON              | ON            | ON (Green)    | Bursts when CPE device communicating | Bursts   | ON         |

**Table 2-1, LEDs and Indications**

## 3.0 Network Configuration

### 3.1 Provisioning the DHCP Server with the MAC Addresses

On the DHCP server, assign the cable modem's CM MAC address with a DOCSIS Configuration File to set modem communication options. (See Section 3.3, The DOCSIS Configuration File for instructions on how to create a DOCSIS Configuration File).

The CM and CPE MAC addresses are located on the shielding on the side of the unit (See the figure below). Record this information prior to installation of the DM3.0 Series Transponder

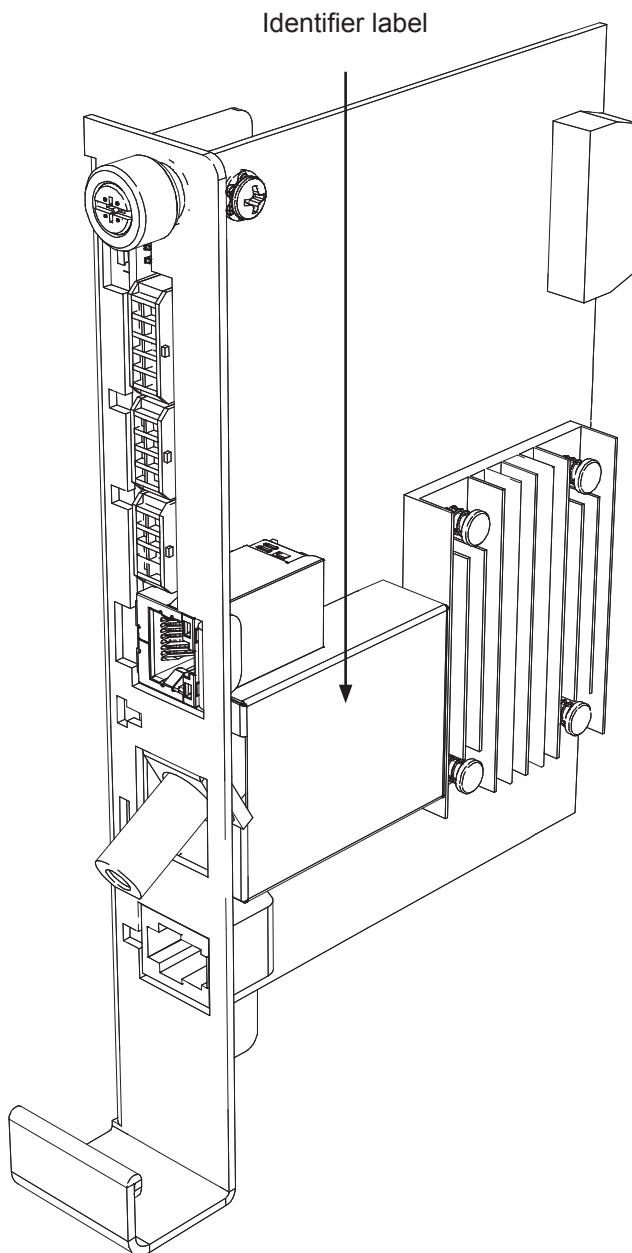

**Fig. 3-1, Locations of MAC Address Labels**

### 3.0 Network Configuration, continued

## 3.2 Establishing IP Connectivity

The DM3.0 Series Transponder supports the CableLabs DOCSIS 3.0 IPv6 implementation. The main benefit of IPv6 is its expanded addressing capability, increasing the address space from 32 to 128 bits, providing virtually unlimited number of networks and systems. The DM3.0 Series Transponder determines the IP provisioning mode via the CableLabs SNMP MIB parameter `docslf3CmMdCfIplProvMode` (SNMP OID: 1.3.6.1.4.1.4491.2.1.20.1.31.1.1). The DM3.0 Series will support the following configurable IP Provisioning Mode Override policies:

- Honor MDD: The cable modem of the DM3.0 Series unit will acquire an IPv6 or IPv4 address as directed by the MAC Domain Descriptor (MDD) message for provisioning and operation.
- IPv4 only: The cable modem of the DM3.0 Series unit will acquire a single IPv4 address for the CM management stack, overriding the TLVs in the MDD message.
- IPv6 only: The cable modem of the DM3.0 Series unit will acquire a single IPv6 address for the CM management stack, overriding the TLVs in the MDD message.

## 3.3 The DOCSIS Configuration File

A cable modem's DOCSIS Configuration File is a type-length-value (TLV) file that contains important operational parameters as defined by the DOCSIS standards. It provides certain settings for the cable modem. In addition to standard entries, settings in the DOCSIS Configuration File should include the modem's community strings and if an upgrade is necessary, firmware upgrade parameters. Place the Configuration File in the TFTP root directory.

The transponder's cable modem interface can support both IPv4 and IPv6 addressing schemes. The required DOCSIS Configuration File operational parameters will differ depending on company policies, cable modem firmware versions and IP addressing schemes. The following DOCSIS Configuration File details listed in this manual are general guidelines. Please consult the published DOCSIS Specification resources (CableLabs) for additional DOCSIS Configuration File details and guidelines.

To build a DOCSIS Configuration File, use a DOCSIS TLV editor program. See the example Configuration Files in Sections 3.3.5 and 3.3.6.

### **NOTICE:**

---

The modem community strings should be set in the DOCSIS Configuration File. Failure to set community strings will result in a less secure system. For automatically updating modem firmware with the DOCSIS Configuration File, see **Section 5.1, Upgrading DM3.0 Series Modem Firmware**.

### 3.0 Network Configuration, continued

#### 3.3.1 Setting Modem Community Strings - docsDevNmAccess Method (IPv4 Only)

Set the modem community strings with the DOCSIS Configuration File by including the following SNMP parameters.

| <b>Modem Community String Parameters docsDevNmAccess Method</b> |                          |  |   |
|---|--------------------------|--|---|
| MIB Parameter   | Object ID                | Description  | Value   |
| docsDevNmAccessIp   | 1.3.6.1.2.1.69.1.2.1.2.x | The IP address (or subnet) of the NMS  | e.g. 10.20.30.0   |
| docsDevNmAccessIpMask   | 1.3.6.1.2.1.69.1.2.1.3.x | The IP subnet mask of the NMS  | e.g. 255.255.255.0  |
| docsDevNmAccessCommunity  | 1.3.6.1.2.1.69.1.2.1.4.x | The community string matched to this IP address net mask entry                     | alphanumeric string   |
| docsDevNmAccessControl  | 1.3.6.1.2.1.69.1.2.1.5.x | The level of access granted  | 1-3<br>None, Read Only, Read / Write  |
| docsDevNmAccessInterfaces                                       | 1.3.6.1.2.1.69.1.2.1.6.x | Specifies the set of interfaces from which requests from this NMS will be accepted | 0x40 : Cable interface (typical)<br>0x80 : Ethernet interface<br>0xC0 or 0x00 : Both interfaces |
| docsDevNmAccessStatus   | 1.3.6.1.2.1.69.1.2.1.7.x | Controls and reflects the status of rows in this table                             | 4   |

Note: X denotes the index of the SNMP entry

**Table 3-1, Modem Community String Parameters - docsDevNmAccess Method**

### 3.0 Network Configuration, continued

#### 3.3.2 Setting Modem Community Strings - Coexistence Method

Set the modem community strings with the DOCSIS Configuration File for an IPv4 or IPv6 network by including the following SNMP parameters:

| Modem Community String Parameters Coexistence Method |                                     |   |   |
|--|-------------------------------------|---|---|
| TLV Type   | TLV Parameter                       | Description   | Value   |
| 53   | SNMPv1v2c Coexistence Configuration | This object specifies the SNMPv1v2c Coexistence Access Control configuration of the CM. This TLV creates entries in SNMPv3 tables as specified in [DOCSIS OSSv3.0]  | Composite   |
| 53.1   | SNMPv1v2c Community Name            | This sub-TLV specifies the Community Name (community string) used in SNMP requests to the CM.   | Text (e.g. AlphaRead)                                 |
| 53.2   | SNMPv1v2c Transport Address Access  | This sub-TLV specifies the Transport Address and Transport Address Mask pair used by the CM to grant access to the SNMP entity querying the CM.   | Variable  |
| 53.2.1   | SNMPv1v2c Transport Address         | Specifies the Transport Address to use in conjunction with the Transport Address Mask used by the CM to grant access to the SNMP entity querying the CM. Length is 6 bytes for IPv4 and 18 bytes for IPv6. Two additional bytes are added to the IP address length for the port number. | Transport Address (e.g. 0.0.0.0/0 or 0:0:0:0:0:0:0/0) |
| 53.2.2   | SNMPv1v2c Transport Address Mask    | Specifies the Transport Address Mask to use in conjunction with the Transport Address used by the CM to grant access to the SNMP entity querying the CM. Length is 6 bytes for IPv4 and 18 bytes for IPv6. Two additional bytes are added to the IP address length for the port number. | Transport Address (e.g. 0.0.0.0/0 or 0:0:0:0:0:0:0/0) |
| 53.3   | SNMPv1v2c Access View Type          | Specifies the type of access to grant to the community name of this TLV. If not specified, default read-only is used.   | 1 = Read Only<br>2 = Read / Write                     |
| 53.4   | SNMPv1v2c Access View Name          | Specifies the name of the view that provides the access indicated in sub-TLV SNMPv1v2c Access View Type.  | String (e.g. docsisManagerView)                       |

**Table 3-2, Modem Community String Parameters - Coexistence Method**



### 3.0 Network Configuration, continued

#### 3.3.3 Setting SNMP Trap Destination Addresses - docsDevNmAccess Method

Set the SNMP Trap Destination Addresses via the DOCSIS Configuration File by including the following SNMP parameters.

| Trap Destination Addresses IPv4 Method |                          |   |   |
|--|--------------------------|---|---|
| MIB Parameter                          | Object ID                | Description   | Value   |
| docsDevNmAccessIP                      | 1.3.6.1.2.1.69.1.2.1.2.x | IP address of trap destination, e.g. NMS server   | e.g. 10.20.30.40  |
| docsDevNmAccessIpMask                  | 1.3.6.1.2.1.69.1.2.1.3.x | Must be set to 255.255.255.255 per RFC 4639   | 255.255.255.255   |
| docsDevNmAccessCommunity               | 1.3.6.1.2.1.69.1.2.1.4.x | Community string used by NMS to query transponder   | alphanumeric string   |
| docsDevNmAccessControl                 | 1.3.6.1.2.1.69.1.2.1.5.x | Level of SNMP access to DM3.0 Series Transponder from IP address specified in docsDevNmAccessIpMask | 4=Read/Only plus Trap<br>5=Read/Write plus Trap<br>6=Trap only, no SNMP access                  |
| docsDevNmAccessInterfaces              | 1.3.6.1.2.1.69.1.2.1.6.x | Specifies the set of interfaces from which requests from this NMS will be accepted                  | 0x40 : Cable interface (typical)<br>0x80 : Ethernet interface<br>0xC0 or 0x00 : Both interfaces |
| docsDevNmAccessStatus                  | 1.3.6.1.2.1.69.1.2.1.7.x | Controls and reflects the status of rows in this table  | 4   |

Note: X denotes the index of the SNMP entry

**Table 3-3, Trap Destination Addresses - docsDevNmAccess Method**

### 3.0 Network Configuration, continued

#### 3.3.4 Setting SNMP Trap Destination Addresses - Coexistence Method

Set the SNMP Trap Destination Addresses via the DOCSIS Configuration File by including the following SNMP parameters:

| Trap Destination Addresses IPv4 Method |   |  |   |
|--|---|--|---|
| TLV Type                               | TLV Parameter                                     | Description  | Value   |
| 38                                     | SNMPv3 Notification Receiver                      | This config file element specifies an NMS that will receive notifications from the modem when it is in Coexistence mode. Up to 10 of these elements may be included in the configuration file. | Composite   |
| 38.1                                   | SNMPv3 Notification Receiver IP Address           | This sub-TLV specifies the IP address of the notification receiver.  | 0:0:0:0:0:0:0 (e.g. fc00:168:1:0:0:0:32)<br>0.0.0.0 (e.g. 10.11.0.1)  |
| 38.2                                   | SNMPv3 Notification Receiver UDP Port Number      | This sub-TLV specifies the UDP port number of the notification receiver. If this sub-TLV is not present, the default value of 162 should be used.  | UDP port number (e.g. 162)  |
| 38.3                                   | SNMPv3 Notification Receiver Trap Type            | This sub-TLV specifies the type of trap to send.   | The trap type may take values:<br>1 = SNMP v1 trap in an SNMP v1 packet<br>2 = SNMP v2c trap in an SNMP v2c packet<br>3 = SNMP inform in an SNMP v2c packet<br>4 = SNMP v2c trap in an SNMP v3 packet<br>5 = SNMP inform in an SNMP v3 packet |
| 38.4                                   | SNMPv3 Notification Receiver Timeout              | This sub-TLV specifies the timeout value to use when sending an Inform message to the notification receiver.   | Time in milliseconds (e.g. 15000)   |
| 38.5                                   | SNMPv3 Notification Receiver Retries              | This sub-TLV specifies the number of times to retry sending an Inform message if an acknowledgement is not received.   | Number of retries (e.g. 3)  |
| 38.6                                   | SNMPv3 Notification Receiver Filtering Parameters | Object Identifier of the snmpTrapOID value that identifies the notifications to be sent to the notification receiver. This notification and all below it will be sent.                         | Filter OID (e.g. 1.3.6)   |

**Table 3-4, Trap Destination Addresses - docsDevNmAccess Method**

 **NOTICE:**

As an alternative to the docsDevNmAccessTable or SNMPv3 trap parameters, SNMP Trap Destination Addresses may be set through the DM3.0 Series proprietary MIB atiMgmtSnmpTrapTable (OID: 1.3.6.1.4.1.926.1.3.1.1) using a SNMP MIB Browser or as an entry in the Proprietary Configuration File 'atidoc33.cfg' in **Section 3.3.6, Sample DOCSIS Configuration File Entries — Coexistence Method**.

### 3.0 Network Configuration, continued

#### 3.3.5 Sample DOCSIS Configuration File Entries - docsDevNmAccess Method

- ① 

```
SNMP MIB Object (11) [Len=21]:docsDevNmAccessStatus.1/4
SNMP MIB Object (11) [Len=21]:docsDevNmAccessIp.1/10.56.21.0
SNMP MIB Object (11) [Len=21]:docsDevNmAccessIpMask.1/255.255.255.0
SNMP MIB Object (11) [Len=25]:docsDevNmAccessCommunity.1/"RW STRING"
SNMP MIB Object (11) [Len=25]:docsDevNmAccessInterfaces.1/"@"
SNMP MIB Object (11) [Len=21]:docsDevNmAccessControl.1/3
```
- ② 

```
SNMP MIB Object (11) [Len=21]:docsDevNmAccessStatus.2/4
SNMP MIB Object (11) [Len=21]:docsDevNmAccessIp.2/10.20.30.40
SNMP MIB Object (11) [Len=21]:docsDevNmAccessIpMask.2/255.255.255.255
SNMP MIB Object (11) [Len=25]:docsDevNmAccessCommunity.2/"RW Trap string"
SNMP MIB Object (11) [Len=25]:docsDevNmAccessInterfaces.2/"@"
SNMP MIB Object (11) [Len=21]:docsDevNmAccessControl.2/5
```
- ③ 

```
Software Upgrade Filename(9) [Len=24]:"ModemFirmwareFile.bin"
SNMP MIB Object (11) [Len=20]:docsDevSwAdminStatus.0/2
```
- ④ 

```
Software Upgrade TFTP Server (21) [Len=4]:10.56.48.15
```
- ⑤ 

```
Manufacturer Code Verification Certificate (32) [Len=254]: 30 82 03 1A 30 82...
Manufacturer Code Verification Certificate (32) [Len=254]: 04 0A 13 11 41 4D...
Manufacturer Code Verification Certificate (32) [Len=254]: 04 0C 30 0A 06 01...
Manufacturer Code Verification Certificate (32) [Len=36]: 11 A3 41 A6 A7 D9....
```

#### Legend

---

- ① Sets Read-Write community string. Set the IP address, netmask and community string to fit your system.
- ② Sets the IP address of where the SNMP traps will be sent. This is typically set to match the IP address of the Network Managements System Server.
- ③ Sets firmware download parameters.
- ④ Specifies the IP address of the TFTP server used for upgrading firmware.
- ⑤ Sets Code Verification Certificate (CVC) for firmware upgrade security per the DOCSIS specification.

### 3.0 Network Configuration, continued

#### 3.3.6 Sample DOCSIS Configuration File Entries - Coexistence Method

①  
SNMPv1v2c Coexistence Configuration  
SNMPv1v2c Community Name:ReadWrite  
SNMPv1v2c Transport Address Access  
SNMPv1v2c Transport Address:0.0.0.0/0  
SNMPv1v2c Transport Address Mask:0.0.0.0/0  
SNMPv1v2c Transport Address Access  
SNMPv1v2c Transport Address:0:0:0:0:0:0:0/0  
SNMPv1v2c Transport Address Mask:0:0:0:0:0:0:0/0  
SNMPv1v2c Access View Type:read-write  
SNMPv1v2c Access View Name:docsisManagerView

②  
Docsis V3 Notification Receiver  
UDP Port number of trap receiver:162  
Type of trap:SNMP v1 trap in an SNMP v1 packet  
Timeout for sending inform:15000  
Number of retries:3  
Filtering Parameters:1.3.6  
IPv6 Address of trap receiver:fc00:168:1:0:0:0:32  
Docsis V3 Notification Receiver  
IP Address of trap receiver:192.168.1.51  
UDP Port number of trap receiver:162  
Type of trap:SNMP v1 trap in an SNMP v1 packet  
Timeout for sending inform:15000  
Number of retries:3  
Filtering Parameters:1.3.6

③  
Software Upgrade Filename:ModemFirmwareFile.bin

④  
Software Upgrade IPv6 TFTP Server:fc00:168:1:0:0:0:51

⑤  
Manufacturer Code Verification Certificate:3082031B30820...  
Manufacturer Code Verification Certificate:040A1312414C5...  
Manufacturer Code Verification Certificate:FF040C300A060...  
Manufacturer Code Verification Certificate:257939C848CE0...

#### Legend

- ① Sets Read-Write community string. Set the IP address, netmask and community string to fit your system.
- ② Sets the IP address of where the SNMP traps will be sent. This is typically set to match the IP address of the Network Managements System Server.
- ③ Sets firmware download parameters.
- ④ Specifies the IP address of the TFTP server used for upgrading firmware.
- ⑤ Sets Code Verification Certificate (CVC) for firmware upgrade security per the DOCSIS specification.

#### **NOTICE:**

DOCSIS configuration files vary from system to system. Take into consideration your company's policies, and test the file on a local system prior to widescale deployment.

In previous versions of the DM product line, an additional configuration file (also known as a Setup File) could be used for distributing custom Alpha MIB settings to all DMs on a network. This is still the case, with the only difference being the name of the file, which for the DM3.0 Series is atidoc33.cfg. It may be used if preferred, but is not required.

## 3.0 Network Configuration, continued

### 3.3.7 Proprietary Configuration File 'atidoc33.cfg'

The DM3.0 Series Transponder will attempt to download a TLV-formatted file 'atidoc33.cfg' from the modem's provisioning TFTP server at start up and every 24 hours thereafter. The atidoc33.cfg proprietary configuration file is optional and provides an alternative method to the modem's DOCSIS configuration file for deploying Alpha proprietary SNMP MIB parameters to field-installed DM3.0 Series Communications Modules.

The atidoc33.cfg file should be used if the following conditions are true:

1. Non-default settings, such as SNMP Trap Destination Addresses need to be distributed to all DM3.0 Series Communications Modules.
2. The operator does not desire to place Alpha-proprietary parameters into the modem's DOCSIS configuration file.



#### **NOTICE:**

---

The recommended method for setting the SNMP trap address(es) is through the modem DOCSIS configuration file (See **Section 3.3, The DOCSIS Configuration File**). Alpha-proprietary parameters may also be set through the modem's DOCSIS configuration file, eliminating the need for the atidoc33.cfg proprietary configuration file.

To build the atidoc33.cfg file, enter the desired SNMP OIDs and values from the Alpha MIB into a TLV file as TLV type-11 entries using a TLV editor (Refer to sample entries below). The DM3.0 Series proprietary configuration Setup file must be named "atidoc33.cfg" and placed in the root directory of the TFTP server. DM3.0 settings are updated according to values defined in this file at start up and after every 24 hours of operation.

Sample atidoc33.cfg Entries:

- Network Access Control (3) [Len - 1]: 1
- SNMP MIB Object (11) [Len = 24]: atiMgmtSnmpTrapAddress.1 / 10.20.30.40
- SNMP MIB Object (11) [Len = 24]: atiMgmtSnmpTrapAddress.2 / 10.20.30.50
- SNMP MIB Object (11) [Len = 23]: atiMgmtSysTamperPolarity.0 / 1

### 3.0 Network Configuration, continued

#### 3.3.8 Changing Default atidoc33.cfg Download Settings

By default the DM3.0 Series Transponder will download the atidoc33.cfg file from the provisioning TFTP server every 24 hours. However, these settings may be adjusted per the tables below by placing the respective SNMP varbinds into the modem's DOCSIS configuration file.

| Default atidoc.cfg Download Settings                        |                     |  |                          |  |
|---|---------------------|--|--------------------------|--|
| Parameter   | Type                | Description                                | Value                    |  |
| atiMgmtSysDownloadConfigName<br>1.3.6.1.4.1.926.1.3.2.1.9.0 | Alphanumeric String | Name of proprietary configuration file     | "atidoc33.cfg" (Default) |  |
| atiMgmtSysDownloadReCfgTime<br>1.3.6.1.4.1.926.1.3.2.1.13.0 | Integer             | Download interval for atidoc33.cfg (hours) | 24 (Default)             |  |

| Search Order | Parameter   | Type       | Description                            | Value                    |
|--------------|---|------------|--|--------------------------|
| 1            | atiMgmtSysDownloadConfigAddress<br>OID 1.3.6.1.4.1.926.1.3.2.1.10.0 | IP Address | Overrides default location             | 0.0.0.0 (Default)        |
| 2            | docsDevServerConfigTftpAddress<br>1.3.6.1.2.1.69.1.4.11.0           | IP Address | Default location (no change necessary) | CM's TFTP Server Address |
| 3            | docsDevSwServerAddress<br>1.3.6.1.2.1.69.1.3.7.0                    | IP Address | Set via DOCSIS configuration file      | Configurable             |
| 4            | Software Upgrade Server   | IP Address | Set via DOCSIS configuration file      | Configurable             |

**Table 3-5, Default atidoc33.cfg Download Settings**

### 3.0 Network Configuration, continued

## 3.4 Setting Communication Options

Communications Settings may be changed through the Alpha MIB remotely using an SNMP MIB browser or automatically by placing the SNMP parameters into the DOCSIS Configuration File.

 **NOTICE:**

Before setting options, verify UDP ports 37, 69, 161, 162 and TCP port 80 are not blocked.

| Communications Parameters  |         |   |   |
|--|---------|---|---|
| SNMP Parameter   | Type    | Description   | Value   |
| atiMgmtSnmpTrapOnNormal<br>OID: 1.3.6.1.4.1.926.1.3.1.5.1.0      | Integer | Send SNMP trap when alarmed condition returns to normal state                         | 1 = Disabled<br>2 = Enabled<br>(Default)                          |
| atiMgmtSysDownloadReCfgTime<br>OID: 1.3.6.1.4.1.926.1.3.2.1.13.0 | Integer | Download interval for DM3.0 Series-specific items in atidoc33.cfg config file (hours) | 24 (Default)  |
| atiMgmtSysSnmpTimeout<br>OID: 1.3.6.1.4.1.926.1.3.1.5.3.0        | Integer | Time DM3.0 Series will wait before reset if SNMP traffic is not detected (minutes)    | 240 (Default)<br>Note: If set to zero, watchdog will be disabled. |
| atiMgmtSysHttpAccess<br>OID: 1.3.6.1.4.1.926.1.3.2.2.4.1.0       | Integer | HTTP Web Server   | 1 = Disabled<br>2 = Enabled<br>(default)                          |

**Table 3-6, Communications Parameters**

 **NOTICE:**

The DM3.0 Series Transponder will inherit the cable modem community string settings provided by the DOCSIS Configuration File.

# 4.0 Web Interface

## Overview

The DM3.0 Series Transponder provides an embedded Web server interface to allow operations personnel the ability to connect locally or remotely via TCP/IP over Ethernet with a laptop/computer to verify the status of common data points and to configure various operating parameters. Unless otherwise stated, data values shown in the figures throughout this section are shown for illustration purposes only.

## 4.1 Local Web Server Access

The DM3.0 Series Transponder's Ethernet port (comparable to the Craft port on some transponder models) will typically be used as a local connection point allowing the user to connect directly to the DM3.0 Series Web server interface to verify/configure common communication parameters and view power supply status and battery values. The Ethernet port on the DM3.0 Series Transponder is a fully functional standard Ethernet port, capable of providing all the functionality of any standard Ethernet connection.

To access the DM3.0 Series Transponder Web server locally utilizing a Web browser, use the following procedure:



### NOTICE:

The following Web browser settings should be 'enabled' for proper rendering/download of the Web pages:

- Java Script
- Cookies
- ActiveX Controls
- Downloads
- Active Scripting
- Show Pictures

These settings are typically enabled in the Web browser by default.

1. Connect a standard Ethernet cable (CAT5) between the DM3.0 Series Transponder Ethernet port (ETH) and a laptop or computer's network interface port.
2. Launch a Web browser.
3. Enter the transponder's default IP address (192.168.100.1) or the DHCP assigned IP address into the Web browser's address field.
4. The transponder's Web server home page will appear (Fig. 4-1). Note: This may take up to 45 seconds when the transponder is initially powered up with no RF connection.
5. Click the Language menu to select a desired language for the text information on the Web page. The language choices are English (default), Spanish, Portuguese, French & German.

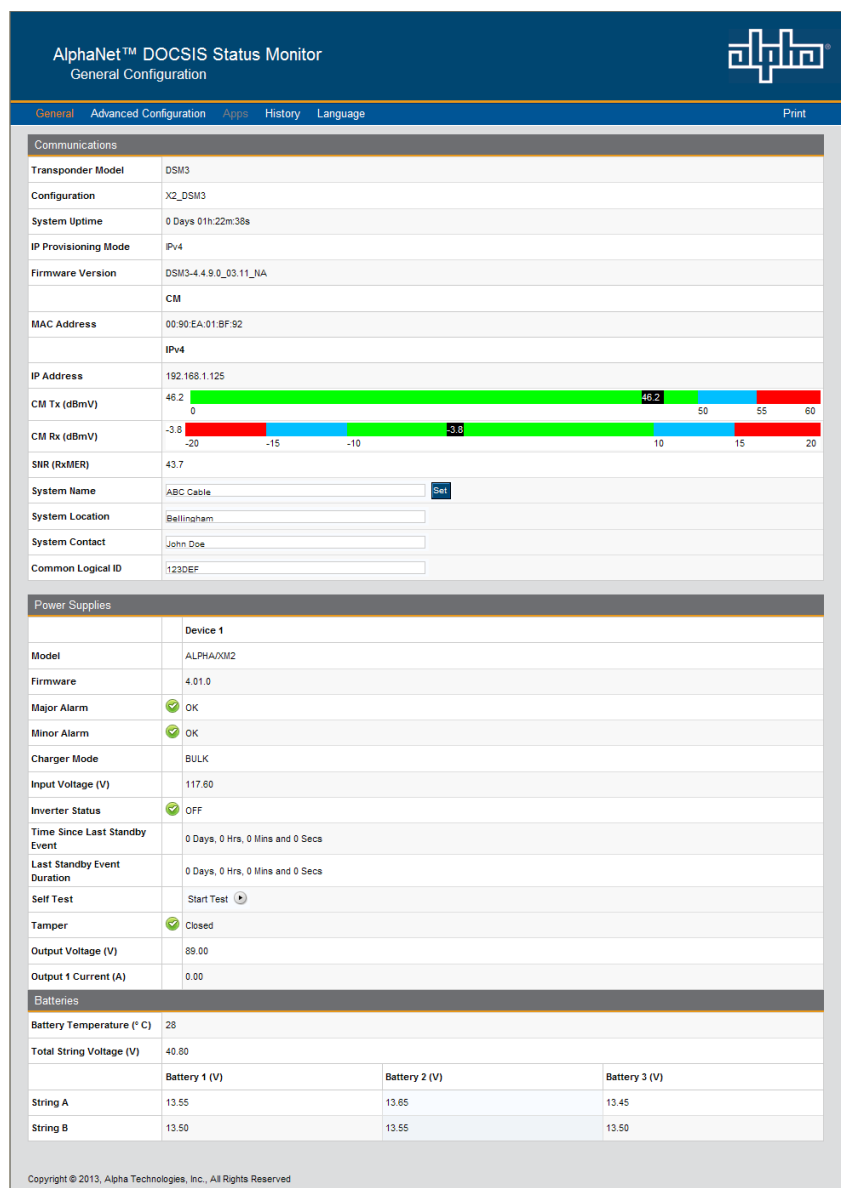

Fig. 4-1, DM3.0 Series Transponder Web Page



## 4.0 Web Interface, continued

### ✓ **NOTICE:**

If you are unable to view the home page of the DM3.0 Series Transponder using IP address 192.168.100.1, the network configuration on the computer that is being used to connect to the DM3.0 Series Transponder may require a temporary static IP address (192.168.100.2) to be configured.

Use the following procedure to configure a static IP address on a laptop or computer with the Windows® 7 operating system:

1. Click the Start button (lower left button on most Windows® computers).
2. When the window pops up, click Control Panel (usually about half the way down the second column).
3. Click Network Connections.
4. Right-Click Local Area Connection link to open menu box.
5. Click the bottom option Properties.
6. You will see a dialog box much like Fig. 4-2; select Internet Protocol (TCP/IP) and then click the Properties button.

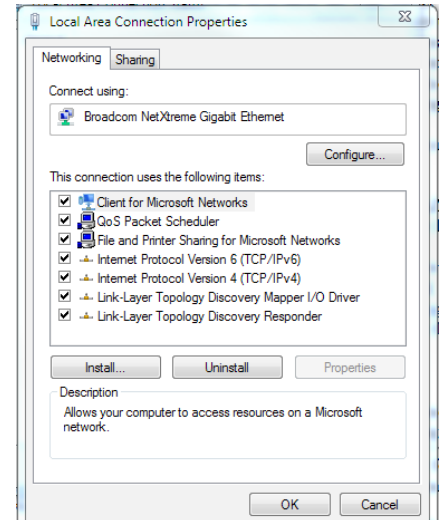

**Fig. 4-2, Local Area Connection Properties Screen, Windows® 7**

7. The Internet Protocol (TCP/IP) Properties dialog box will open (Fig. 4-3). Select "Use the following IP address". Enter the values as shown (i.e. IP address 192.168.100.2 and Subnet mask 255.255.255.0). Record the existing IP address and Subnet mask in order to later return the computer to its original state.
8. Click the OK button and try to connect to the DM3.0 Series Transponder once again using 192.168.100.1 in the Web browser.
9. To restore network settings, repeat Steps 1 through 6 but in step 7 click check box for "Obtain IP address automatically or, manually set back to the original settings recorded in Step 7.

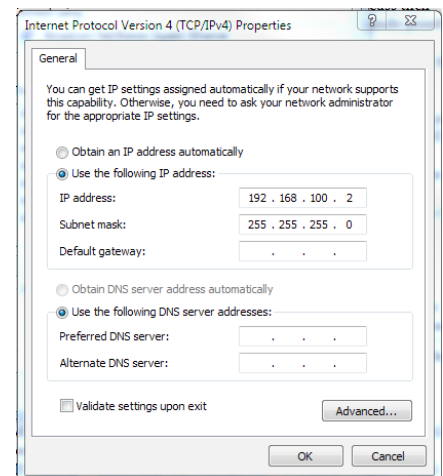
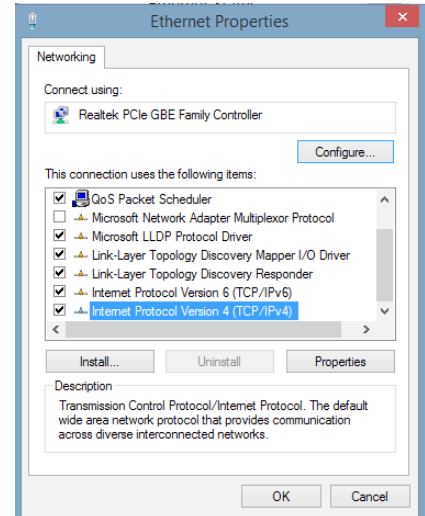

**Fig. 4-3, Internet Protocol (TCP/IP) Properties Screen, Windows® 7**

## 4.0 Web Interface, continued

Use the following procedure to configure a static IP address on a laptop or computer with the Windows® 8 or Windows® 10 operating system:

1. Right click the Start button (lower left button on most Windows® computers).
2. When the window pops up, click Control Panel (usually about half the way down the second column).
3. Click Network and Sharing Center.
4. Click Ethernet.
5. Click the Properties button.
6. You will see a dialog box much like Fig. 4-4; click Internet Protocol (TCP/IPv4) and then click the Properties button.



**Fig. 4-4, Local Area Connection Properties Screen, Windows® 8**

7. The Internet Protocol (TCP/IP) Properties dialog box will open (Fig. 4-5). Select “Use the following IP address”. Enter the values as shown (i.e. IP address 192.168.100.2 and Subnet mask 255.255.255.0). Record the existing IP address and Subnet mask in order to later return the computer to its original state.
8. Click the OK button and try to connect to the DM3.0 Series Transponder once again using 192.168.100.1 in the Web browser.
9. To restore network settings, repeat Steps 1 through 6.

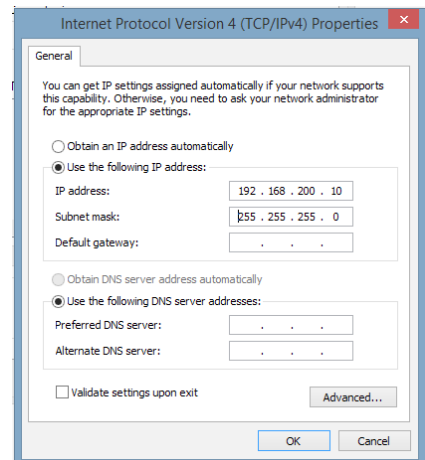

**Fig. 4-5, Internet Protocol (TCP/IP) Properties Screen, Windows® 8**

## 4.0 Web Interface, continued

### 4.2 Remote Web Server Access

To remotely access the DM3.0 Series Transponder Web server utilizing a Web browser, use the following procedure:

#### **NOTICE:**

For Web server (HTTP) access, port 80 must not be blocked and the computer must have access to the private cable modem network

1. Connect the laptop or computer's network interface port to the company's Ethernet network.
2. Open a Web browser.
3. Enter the DM3.0 Series' DHCP designated IP address (e.g., 192.168.1.124) into the Web browser's address field. Use square brackets when entering IPv6 IP addresses (e.g. [FC00:168:40::124]) into the Web browser's address field.
4. The DM3.0 Series Transponder's Web server home page will appear (Fig. 4-6).
5. Click on the Language menu to select a desired language for the text information on the Web page. The language choices are English (default), Spanish, Portuguese, French and German.

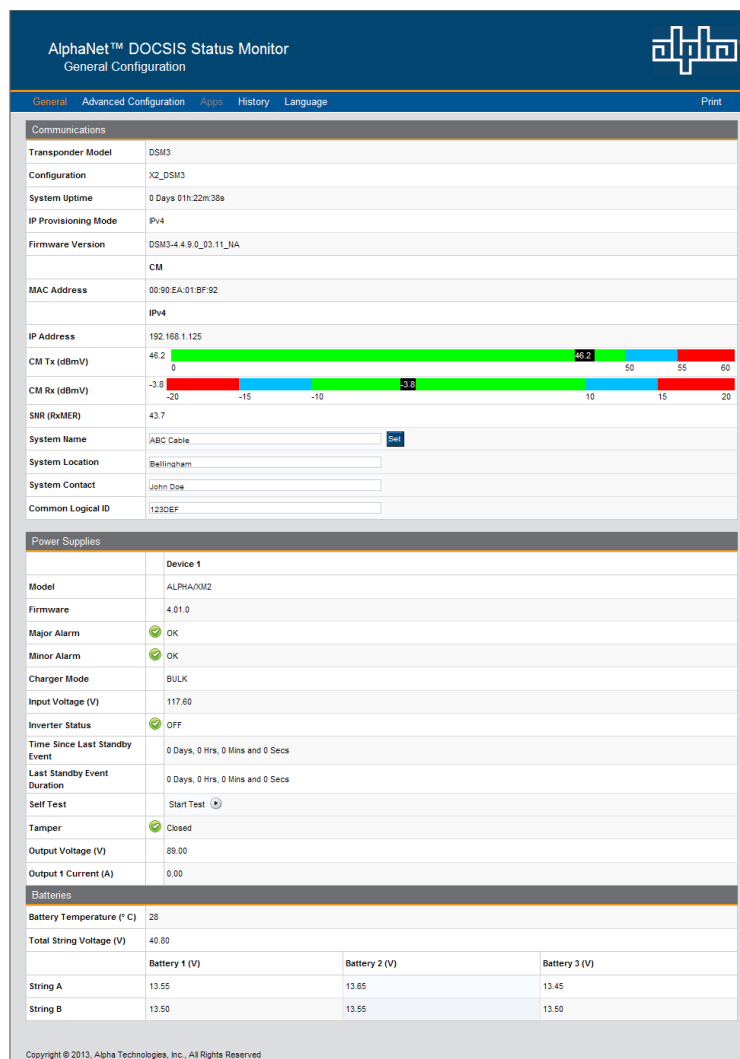

Fig. 4-6, Web Server Home Page

## 4.0 Web Interface, continued

### 4.3 Navigating the Web Page

Once the Web page has been successfully accessed, the operator is able to select a link on the header bar and the page specific to the topic will open enabling real-time data to be observed.

See Fig. 4-7 for the navigation bar items.

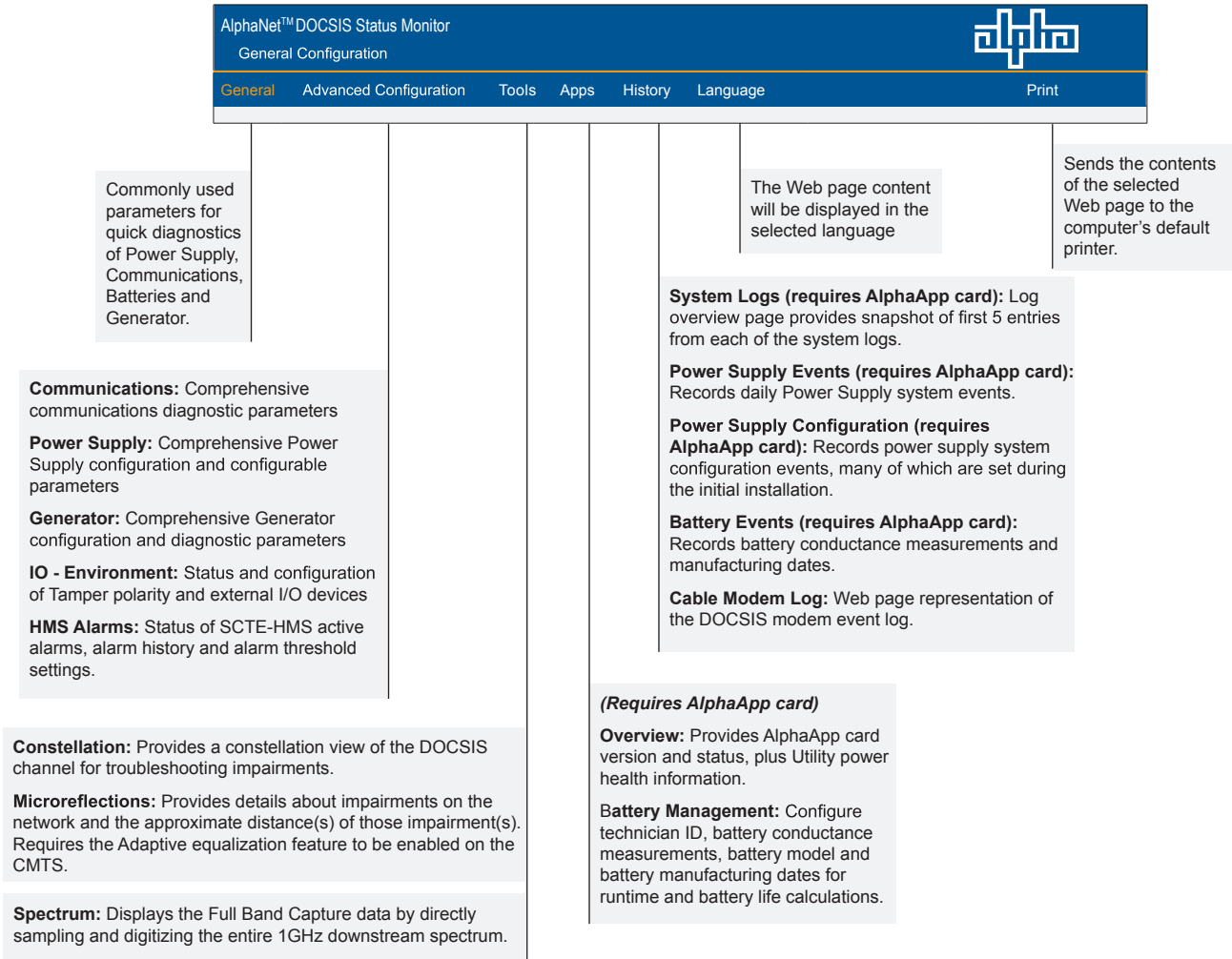

Fig. 4-7, Navigation Bar Items

## 4.0 Web Interface, continued

### 4.3.1 Web Interface Security Levels

The DM3.0 Series Transponder has two levels of function-specific security. General operations are Level 1. Configuration-related functions are Level 2. Refer to Table 4-1 for default User Name and Security Passwords.

| DM3.0 Series Transponder Web Page Security |                           |          |
|--|---------------------------|----------|
| OID  | Function                  | Value    |
| 1.3.6.1.4.1.4413.2.2.2.1.1.3.3.0           | Level 1 User Name         | Alpha    |
| 1.3.6.1.4.1.4413.2.2.2.1.1.3.4.0           | Level 1 Security Password | AlphaGet |
| 1.3.6.1.4.1.4413.2.2.2.1.1.3.1.0           | Level 2 User Name         | Alpha    |
| 1.3.6.1.4.1.4413.2.2.2.1.1.3.2.0           | Level 2 Security Password | AlphaSet |

**Table 4-1, DM3.0 Series Transponder Web Page Security**

| DM3.0 Series Transponder Security Levels |   |                |
|--|---|----------------|
| Web Page                                 | Function  | Security Level |
| General                                  | System Name, System Contact, System Location, Common Logical ID | 1              |
|  | Power Supply Self Test  | 1              |
|  | Generator Self Test   | 1              |
| Advanced Communications                  | Reset Transponder   | 1              |
|  | Provisioning Mode - Single IP or Dual IP                        | 2              |
|  | Configure Proprietary Trap Addresses                            | 2              |
| Advanced Power Supply                    | Power Supply Self Test  | 1              |
|  | Configure / Save  | 2              |
|  | Reset Output 1 / 2  | 2              |
| Advanced Generator                       | Generator Self Test   | 1              |
|  | Reset Latched Alarms  | 1              |
| Modem Log [Event Log]                    | Reset Log   | 1              |
| Advanced I/O                             | Tamper Switch Polarity  | 1              |
|  | Enclosure Heater / Controller Installed                         | 1              |
| HMS Alarms                               | Export Alarm Cloning File                                       | 2              |
| Apps Overview                            | Configure / Save  | 2              |
| Battery Management                       | Configure / Save  | 2              |
| Constellation                            | Number of Samples   | 2              |

**Table 4-2, DM3.0 Series Transponder Security Levels**

The Web page of the DM3.0 Series Transponder provides some basic tools for analyzing impairments on the DOCSIS.

## 4.0 Web Interface, continued

### 4.4 Verifying Communication Parameters

Click the General menu of the Web page to display common communication settings and values. Click the Advanced Communication menu to view additional communication parameters.

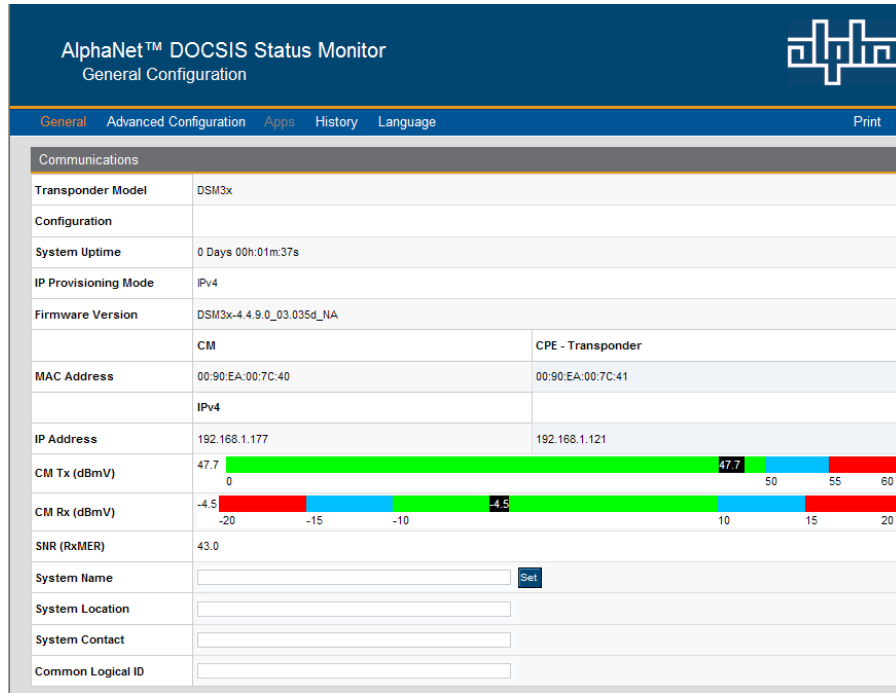

Fig. 4-8, Communication Parameters

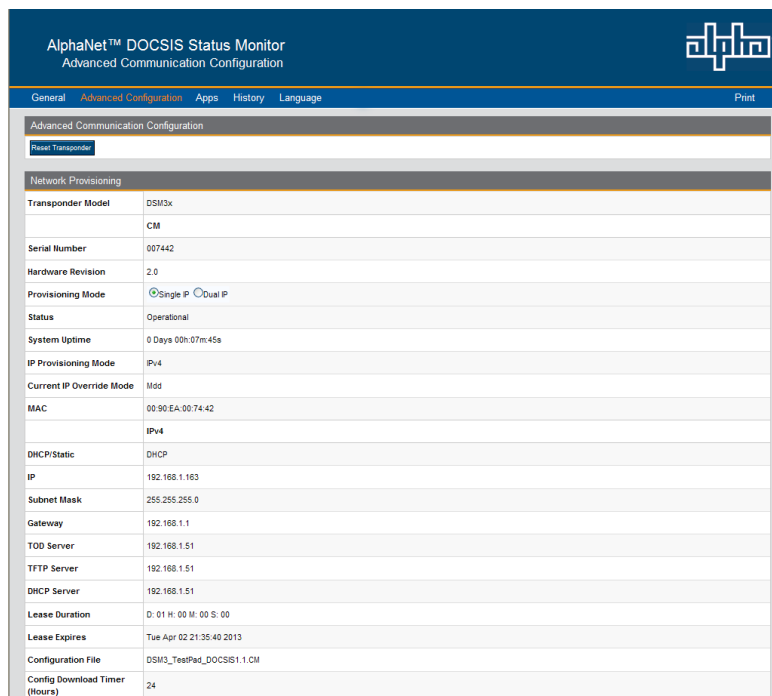

Fig. 4-9, Advanced Communication Parameters

## 4.0 Web Interface, continued

### 4.5 Verifying Power Supply and Battery Parameters

Click the General menu to access Power Supply and individual battery voltage values. Important parameters such as current alarm status, inverter status and tamper status can be quickly verified on this page. Additional power supply parameters can be viewed and configured on the Power Supply page located in the Advanced Configuration menu.

| Power Supplies                   |                                   |               |               |
|----------------------------------|-----------------------------------|---------------|---------------|
| Device 1                         |                                   |               |               |
| Model                            | ALPHA/PS MODEL NOT SET            |               |               |
| Firmware                         | V1.06.0                           |               |               |
| Major Alarm                      | OK                                |               |               |
| Minor Alarm                      | OK                                |               |               |
| Operational Mode                 | LINE                              |               |               |
| Charger Mode                     | Float                             |               |               |
| Input Voltage (V)                | 120.00                            |               |               |
| Inverter Status                  | OFF                               |               |               |
| Time Since Last Standby Event    | 0 Days, 0 Hrs, 0 Mins and 0 Secs  |               |               |
| Last Standby Event Duration      | 0 Days, 0 Hrs, 10 Mins and 8 Secs |               |               |
| Self Test                        | Start Test                        |               |               |
| Tamper                           | Closed                            |               |               |
| Output Voltage (V)               | 87.00                             |               |               |
| Output 1 Current (A)             | 11.60                             |               |               |
| Output 2 Current (A)             | 0.00                              |               |               |
| Batteries                        |                                   |               |               |
| Battery String Runtime Remaining | Calculating                       |               |               |
| Battery Balancing                | Balancing String A                |               |               |
| Battery Temperature (° C)        | 15                                |               |               |
| Total String Voltage (V)         | 41.20                             |               |               |
|                                  | Battery 1 (V)                     | Battery 2 (V) | Battery 3 (V) |
| String A                         | 13.90                             | 13.90         | 13.90         |
| String B                         | 13.90                             | 13.90         | 13.80         |

Fig. 4-10, Power Supply and Battery Parameters

### 4.6 Remote Self Tests via the Web Page

Remote Self Tests on power supplies may be started and stopped via the transponder Web page. This requires a Level 1 login. Refer to Section 4.3.1, Web Interface Security Levels for User Name and Security Password.

To launch a remote Self Test, click the Start Test button seen in Fig. 4-10.

To stop a remote Self Test before the predefined test duration, click the Stop Test button.

## 4.0 Web Interface, continued

### 4.7 Viewing HMS Alarm Status via the Web Page

HMS alarms levels and current states may be viewed by clicking on the HMS Alarms link on the Advanced Configuration menu (see Fig. 4-11). Parameter values cannot be edited on this Web page. An SNMP MIB browser or status monitoring software may be used for such edits.

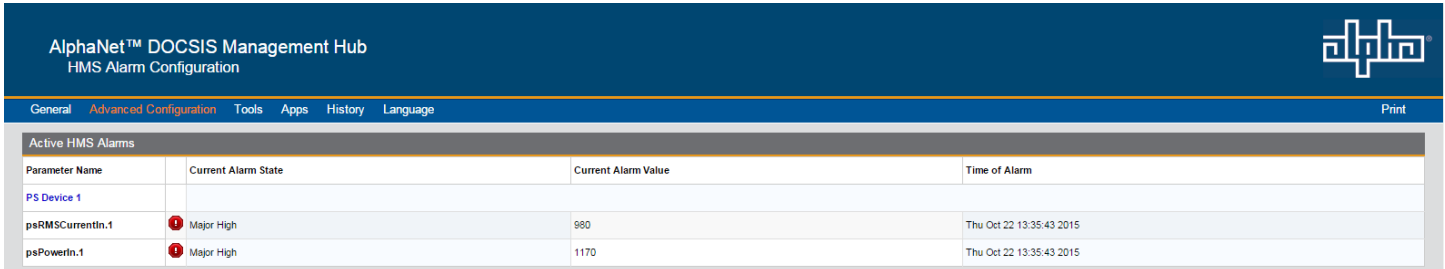

| Parameter Name           | Current Alarm State | Current Alarm Value | Time of Alarm            |
|--------------------------|---------------------|---------------------|--------------------------|
| <b>Active HMS Alarms</b> |                     |                     |                          |
| <b>PS Device 1</b>       |                     |                     |                          |
| psRMSCurrentIn.1         | Major High          | 980                 | Thu Oct 22 13:35:43 2015 |
| psPowerIn.1              | Major High          | 1170                | Thu Oct 22 13:35:43 2015 |

Fig. 4-11, HMS Alarm Configuration

Alarms settings may be exported by selecting the Export button at the bottom of the page. Alarms settings may be distributed to other DM3.0 Series units. For more details, refer to the DM3 Alarm Cloning and Distribution section under Section 6.2.1, SCTE-HMS Configurable Alarms.



Fig. 4-12, HMS Alarm Configuration - Export Settings



## 4.8 Setting the I/O Controller via the Web Page

Access the I/O Environment page in the Advanced Configuration menu to adjust the settings for the Tamper Switch and I/O Controller. The Tamper Switch polarity may be changed by clicking on the preferred tamper switch polarity button. The I/O Controller section provides a user interface to select the type of device that will be connected and monitored via the ENV connector of the transponder. An example of such a device would be the battery heater mat controller.

AlphaNet™ DOCSIS Status Monitor  
Advanced I/O Controller

General **Advanced Configuration** Apps History Language Print

**Tamper**

Status

Tamper Switch Status: Open

Tamper Switch Polarity:  Default  Reversed

**I/O Controller**

Connected Device(s): Heater / Cooler Only

|        | Status   | Temperature | Hysteresis | Timer | Countdown |
|--------|----------|-------------|------------|-------|-----------|
| Heater | Inactive | 0           | 1          | 30    | 0         |

Contact Polarity:  Default  Reversed

Pin 3 - Open/Close Control: Open

Pin 4 - Open/Close Sense: Open

Pin 5 - Open/Close Sense: Open

Pin 6 - Open/Close Sense: Open

Pin 7 - Open/Close Control: Open

Pin 8 - Open/Close Sense: Open

Fig. 4-13, Advanced I/O Controller Status Screen

## 4.0 Web Interface, continued

### 4.9 Viewing and Configuring Power Supply Settings via the Web Page

Click the Advanced Configuration menu and select Power Supplies to view connected power supply parameters. The power supply parameters with a formatted text box or a menu around the value can be configured. Click the Start Test button to remotely initiate power supply tests. When prompted, refer to Section 4.3.1, Web Interface Security Levels for the applicable User Name and Security Password.

AlphaNet™ DOCSIS Management Hub  
Advanced Power Supply

General **Advanced Configuration** Tools Apps History Language
Print

**Hardware and Firmware**

|                                     | Firmware                       | Serial Number   | Part Number      | Hardware ID | Configuration              |
|-------------------------------------|--------------------------------|-----------------|------------------|-------------|----------------------------|
| <b>Power Supply 1 - XM3-918D-HP</b> |                                |                 |                  |             |                            |
| <b>Transformer Module</b>           |                                | A221235F1900832 | 017-893-20-001   |             | XM3C269C183CU<br>20031-2L- |
| Transformer                         |                                | GT0901314F00001 | 241-193-19-001 A |             |                            |
| Power Distribution Board            |                                | A221237F19C0454 | 70486920001B --  | 2           |                            |
| Ferro Capacitor                     |                                | 1002004587057-2 |                  |             |                            |
| EMI Board                           |                                | A221236F19G0872 | 704-896-20-001 A |             |                            |
| <b>Inverter Module</b>              |                                | A221235F1900832 | 746-173-22-001   |             | XM3C269C183CU<br>20031-2L- |
| Inverter PCBA                       |                                | A221235F19B1083 | 70486320001E --  | 1           |                            |
| Micro PCBA                          | FW V1.11.0 J                   | A221235F19A0096 | 70487320001F --  | 257         |                            |
| <b>Optional Components</b>          |                                |                 |                  |             |                            |
| DM3u                                | DM3u-5.7.1mp1_01_055_01.014-NA | 181022          |                  |             |                            |
| Dual Output Controller              | DOC FW V1.04.0                 | DOC S/N NOT SET | DOC P/N NOT SET  | 10          |                            |
| Battery Balancer                    | SAG FW V1.07.3                 | A221233F19N2234 | 70487421001A --  | 34          |                            |
| Apps Card                           | APP FW V1.09.00                | A221234F19S3926 | 70487922001H --  | 10          |                            |

**Configuration and Data**

Configure / Cancel / Save
[Configure](#)

---

**Power Supply**

Power Supply Language: English

Device 1

Power Supply Model: XM3-918D-HP

Power Supply Major Alarms: OK

Power Supply Minor Alarms: OK

Operational Mode: Line

Set Power Supply Defaults: Reset

Device Address: 1

Power Supply Priority Level: Normal

Last Reset Reason: REPRGRM

AlphaBus Speed: 57.6 AB

---

**Input**

AC Line Mode: OK

Input Voltage (V): 121.20

Input Freq (Hz): 60.00

Input Current (A): 9.80

Input Power (W): 1150.00

Tap Status: Normal

General IPU Status: OK

Input Frequency Range (Hz): 9.00

Fig. 4-14, Advanced Power Supply Settings Screen

## 4.0 Web Interface, continued

|  |  |
|--|--|
| Input Current Limit (A)                    | <input type="text" value="17.00"/>   |
| <b>Inverter</b>                            |  |
| Inverter Status                            | OFF  |
| Inverter Enable                            | Enabled  |
| End of Discharge Type                      | String   |
| End of Discharge (V/C)                     | <input type="text" value="1.70"/>  |
| Reduced Peak Mode                          | Enabled  |
| Standby Events - Inverter                  | 635  |
| Time Since Last Standby Event              | 0 Days, 0 Hrs, 0 Mins and 0 Secs   |
| Last Standby Event Duration                | 0 Days, 0 Hrs, 8 Mins and 0 Secs   |
| Total Time in Standby - Inverter (Minutes) | 3226   |
| Total Run Time - Inverter (Days)           | 834  |
| <b>Resettable Standby Counters</b>         |  |
| Standby Events Since Reset                 | 37   |
| Time in Standby Since Reset (Minutes)      | 369  |
| Time Since Reset - (Days)                  | 834 <input type="button" value="Reset"/>                                       |
| <b>Battery Charging</b>                    |  |
| Battery String Voltage (V)                 | 40.60  |
| Battery String Runtime Remaining           | <input checked="" type="checkbox"/> > 3 Hours                                  |
| Charger Mode                               | Rest   |
| Time Running in Current Charger Mode       | 0 Days, 2 Hrs, 29 Mins and 0 Secs  |
| 24 Hour Battery Refresh                    | <input checked="" type="radio"/> Disabled <input type="radio"/> Enabled        |
| Battery Temperature (° F / ° C)            | 66 / 19  |
| Charger Current (A)                        | 0.00   |
| Charger Current Limit (A)                  | 10.50  |
| Charger Current Limit (A)                  | 10.50  |
| Charger Enable                             | Enabled  |
| Battery Discharge Current (A)              | 0.00   |
| Battery Model                              | 4.DHP  |
| Charger Accept Voltage (V/C)               | <input type="text" value="2.38"/>  |
| Charger Float Voltage (V/C)                | <input type="text" value="2.25"/>  |
| Charger Refresh Voltage (V/C)              | <input type="text" value="2.45"/>  |
| Charger Temperature Compensation (mV)      | <input type="text" value="4.00"/>  |
| HP Battery Rest Charger Mode               | <input type="radio"/> Disabled <input checked="" type="radio"/> Enabled        |
| Battery Capacity (AH)                      | <input type="text" value="114"/>   |
| Battery String Detect                      | Auto   |
| Number of Battery Strings                  | 2  |
| Heater Mat Installed                       | <input type="radio"/> Not Installed <input checked="" type="radio"/> Installed |
| Battery Balancing                          | <input checked="" type="checkbox"/> Idle                                       |

Fig. 4-14, Advanced Power Supply Settings Screen, Continued



### NOTICE:

When the Battery Model is set to “Other”, the battery charging parameters such as charger voltages, battery capacity, and temperature compensation can be customized, otherwise default values are populated for Alpha supported batteries. For systems with more than one power supply, the master unit will override the charger parameter settings.

## 4.0 Web Interface, continued

| Self Test   |   |
|---|---|
| Self Test   | Start Test <input type="button" value="⌵"/> |
| Deep Discharge Cycle (%)  | Timed <input type="button" value="▼"/>      |
| Test Countdown (Days)   | 15 <input type="text"/>                     |
| Test Duration (Minutes)   | 8 <input type="text"/>                      |
| Test Interval (Days)  | 30 <input type="text"/>                     |
| Test Inhibit  | OFF <input type="button" value="▼"/>        |
|   |   |
| Output  |   |
| Output Voltage (V)  | 87.00                                       |
| Output 1 Current (A)  | 12.00                                       |
| Output 2 Current (A)  | 0.00  |
| Output Power Real (Watts)                                       | 1030.00                                     |
| Output Power Apparent (VA)                                      | 1030.00                                     |
| Percent Load (%)  | 66.00                                       |
| Output 1 Enable   | Enabled                                     |
| Output 2 Enable   | Enabled                                     |
| Output Setting  | 90 Volts                                    |
| Output Regulation   | Course <input type="button" value="▼"/>     |
| Reset Output 1  | <input type="button" value="Reset"/>        |
| Reset Output 2  | <input type="button" value="Reset"/>        |
| Overcurrent Tolerance (mSec)                                    | 3000 <input type="text"/>                   |
| Output 1 Overcurrent Trip Level (A)                             | 15.00 <input type="text"/>                  |
| Output 2 Overcurrent Trip Level (A)                             | 19.40 <input type="text"/>                  |
| N+1 Valid   | No  |
| Retry Delay (Seconds)   | 90 <input type="text"/>                     |
| Retry Limit   | 20 <input type="text"/>                     |
| <a href="#">Download Diagnostics Log (CSV)</a>                  |   |
| Copyright © 2015, Alpha Technologies, Inc., All Rights Reserved |   |

Fig. 4-14, Advanced Power Supply Settings Screen, Continued

## 4.0 Web Interface, continued

### 4.10 Viewing and Configuring Generator Settings Via the Web Page

When a permanent, fixed generator is connected to a DM3X, the generator page listed in the Advanced Configuration menu will populate a list of the various parameters and alarm statuses. Generator Self Tests may be remotely started by clicking on the Start Test button. When prompted, refer to Section 4.3.1, Web Interface Security Levels for User Name and Security Password.

The screenshot displays the 'Advanced Generator' status screen. At the top, there is a navigation bar with 'General', 'Advanced Configuration', 'Apps', 'History', and 'Language' tabs, and a 'Print' button. The main content area is divided into several sections:

- Status:**
  - Firmware Version: CODE VER 1.29.0
  - Generator Status: RUNNING - AC Line Fail
  - Engine Enable/Disable: ENABLED
  - Engine Run Time (dHR): 820
- Engine Status / Alarms:**
  - Reset Latched Alarms: [Reset Latched Alarms](#)
  - AC Line Status: 1 LOST
  - AC Line Voltage (Vac): 0.00
  - DC Bus Status: ✔ OK
  - DC Bus Voltage (Vdc): 38.00
  - Over Voltage: ✔ OK
  - Self Test Alarm: ✔ OK
  - Generator Control: Start Test ▶
  - Low Ignition Battery: ✔ OK
  - Ignition Battery Voltage (Vdc): 13.88
  - Service Required: ⚠ YES
  - Low Oil Pressure: ✔ OK
  - High Engine Temperature: ✔ OK
  - Over Speed: ✔ OK
  - Over Crank: ✔ OK
  - Low Fuel Level: ✔ OK
- Settings:**
  - Start Delay (Sec): 180
  - Cool-Down Period (Sec): 720
  - Low DC Bus Level (Vdc): 35.00
  - Hi DC Bus Level (Vdc): 45.00
  - Over-voltage Duration (SEC): 5
  - Automatic Test Interval (HR): 30
  - Test Countdown (Hr): 136
  - Test Duration (Min): 15
  - Service Interval (HR): 100
  - Service Due (HR): 0
- CONTROL ALARMS:**
  - Control Fail: ✔ OK
  - RAS Switch: ✔ AUTO
- Enclosure Alarms:**
  - Gas Hazard (LEL): ✔ OK
  - Water Intrusion: ✔ OK
  - Pad Shear: ✔ OK
  - Tamper: ✔ OK

Copyright © 2012, Alpha Technologies, Inc., All Rights Reserved

Fig. 4-15, Advanced Generator Status Screen

## 4.0 Web Interface, continued

### 4.11 Tools Menu - Constellation, Microreflections, and Spectrum

The Web page of the DM3.0 Series Transponder provides some basic tools for analyzing impairments on the DOCSIS network. The “Tools” menu selection on the Web page provides access to the Constellation, Microreflections, and Spectrum tools.

#### 4.11.1 QAM Constellation Tool

The Constellation page provides a constellation view of the DOCSIS channel that may assist in identifying and troubleshooting common network impairments.

Navigate the mouse pointer to the Tools menu item and select “Constellation” in the drop down menu to open and start the Constellation page. The page will automatically refresh until the samples remaining counter reaches 0. Clicking the Restart button refreshes the constellation tool, and clicking the Stop button halts the analysis.

The number of samples can be changed from 100 (default) on the sampling control to either 150 or 50 for more or less sample rates. For User Name and Password refer to Section 4.3.1, Web Interface Security Levels.

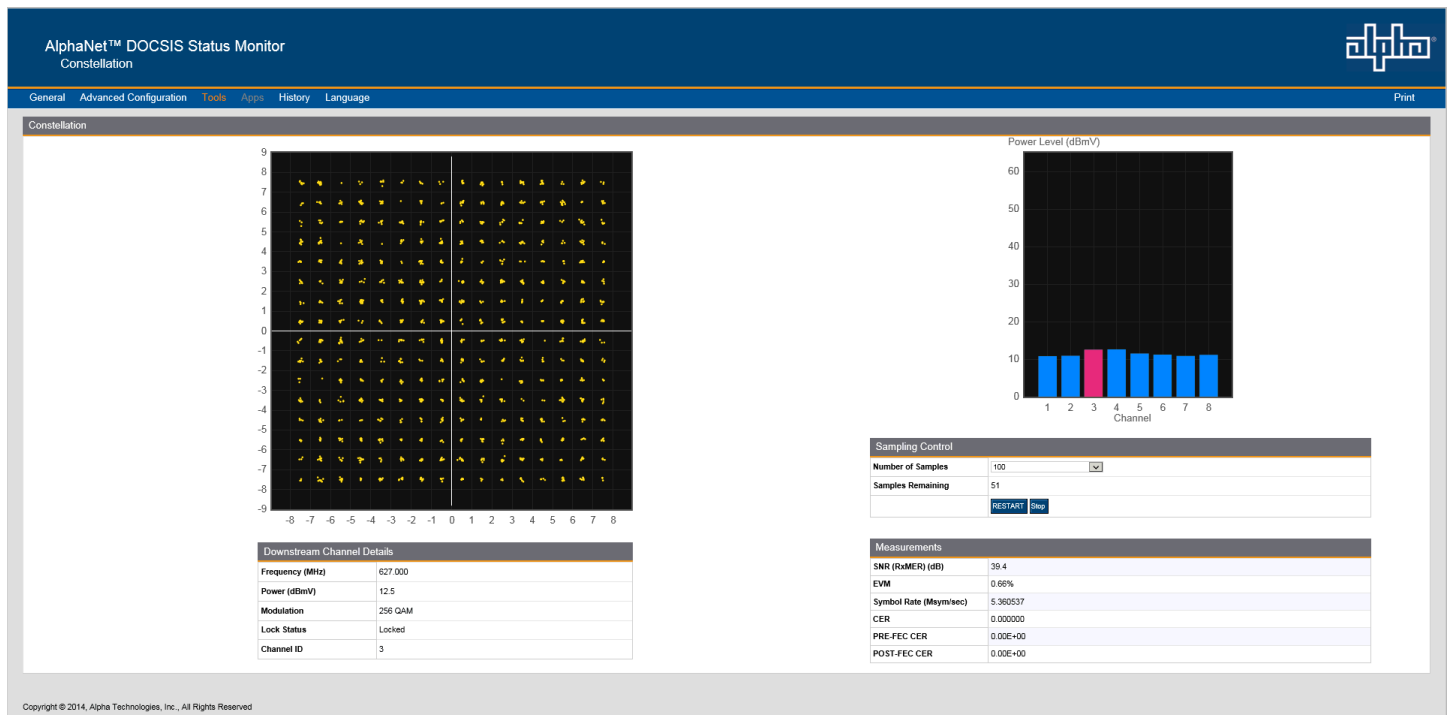

Fig. 4-16, QAM Constellation Tool

## 4.0 Web Interface, continued

The tables on the right hand side of the screen provide a summary of common parameters associated with QAM Constellation analysis. Here's a breakdown of the parameters listed:

- Frequency - The tuned downstream frequency given in MHz.
- Power – Downstream power given in dBmV.
- Modulation – Modulation type associated with the downstream channel.
- Lock Status – Current cable modem connectivity state.
- Channel ID – CMTS identification of the downstream channel within this particular MAC interface.
- SNR / (RxMER) – Downstream signal quality. Modulation Error Ratio (MER)
- EVM – Error Vector Magnitude (from hardware Modulation Error Ratio (MER) / software MER).
- Symbol Rate – Msym/sec
- CER Interval – Codeword Error Rate (CER) refresh rate.
- Pre FEC CER – Codeword Error rate (CER) BEFORE forward error correction is applied.
- Post FEC CER – Codeword Error rate (CER) AFTER forward error correction is applied.

### 4.11.2 QAM Constellation Common Impairments

Several common impairments tend to reveal themselves on the constellation display which can help determine the cause of the reduced MER levels. Below are examples of several of these common impairments and their footprints.

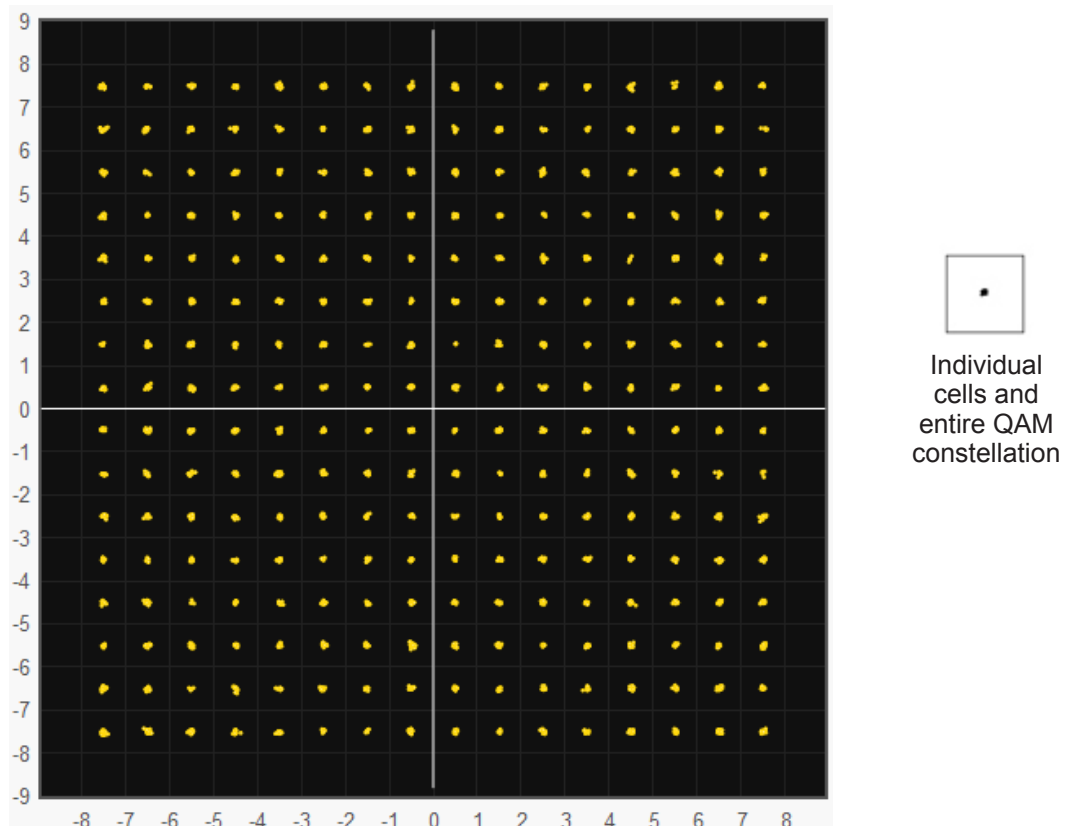

Fig. 4-17, Normal - (Good Quality) and Individual Cell Characteristics

4.0 Web Interface, continued

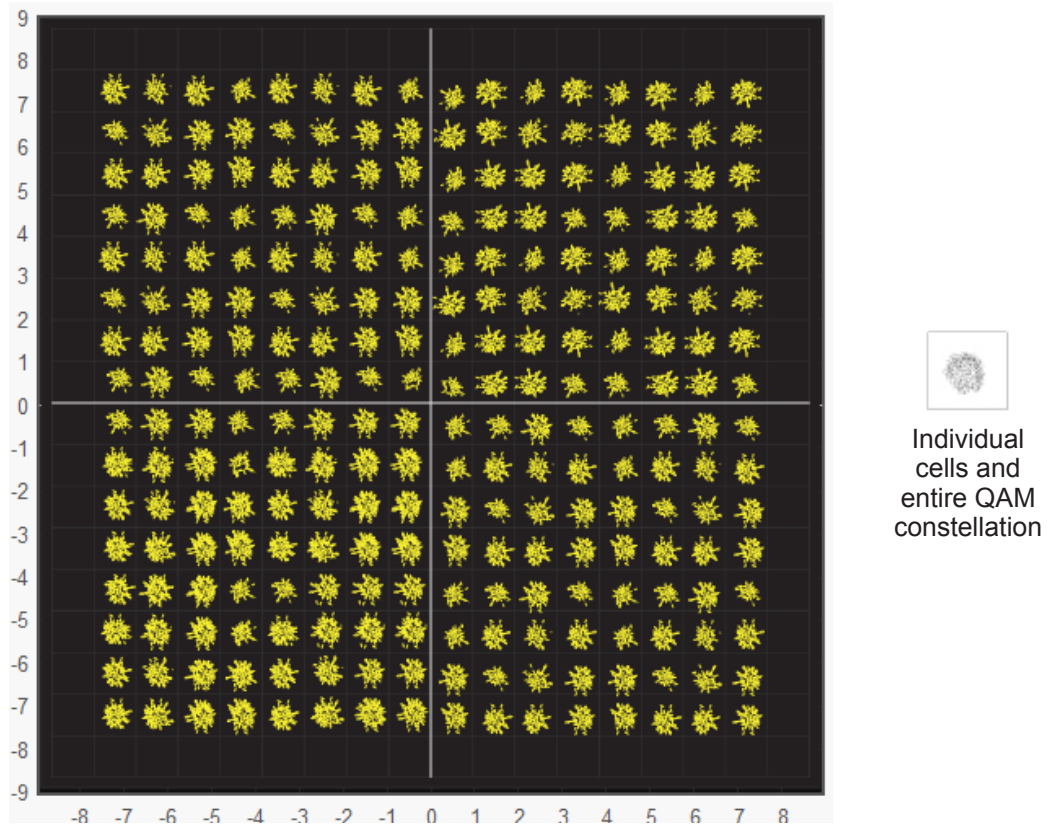

Fig. 4-18, Fuzzy (Low CNR and/or Low MER) and Individual Cell Characteristics

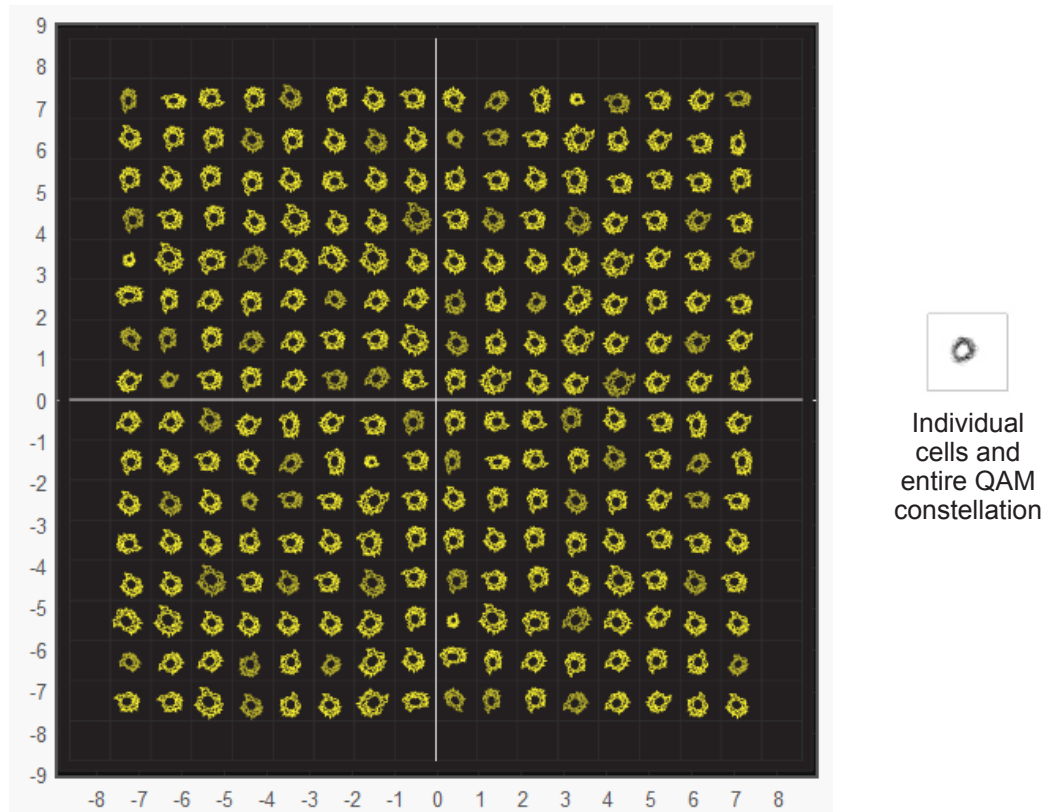
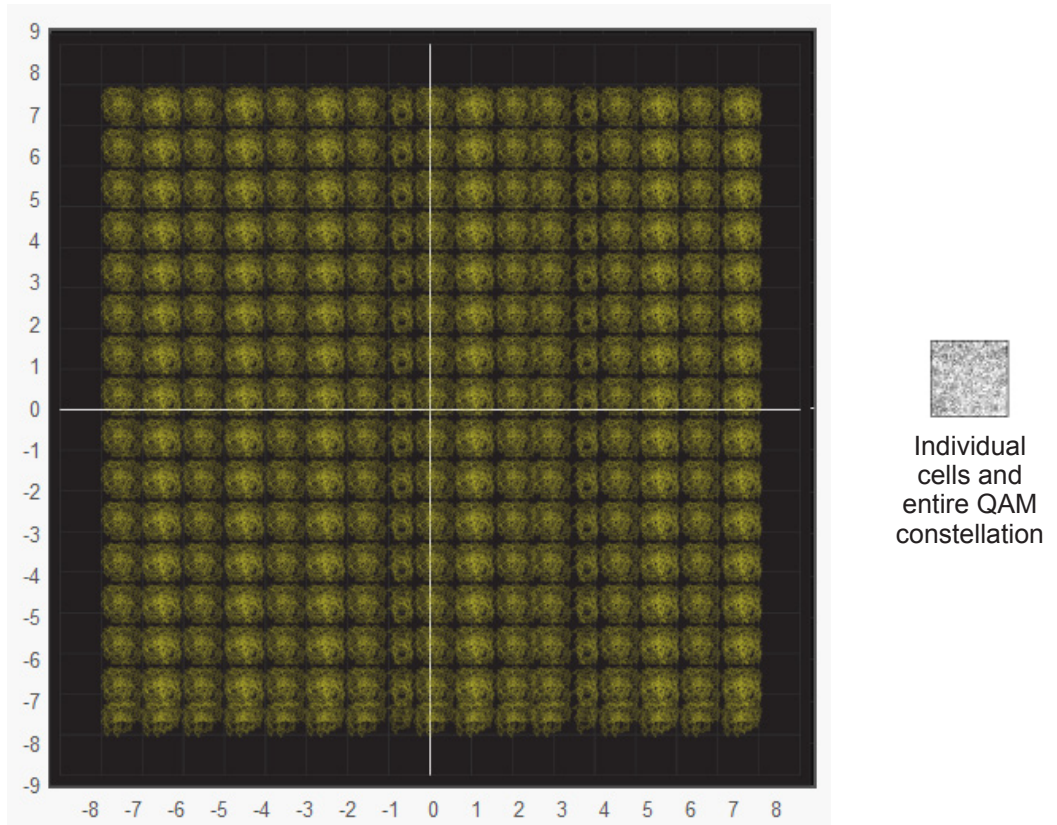

Fig. 4-19, Doughnuts (Coherent Interference) and Individual Cell Characteristics



#### 4.0 Web Interface, continued



**Fig. 4-20, Gaussian Noise and Individual Cell Characteristics**

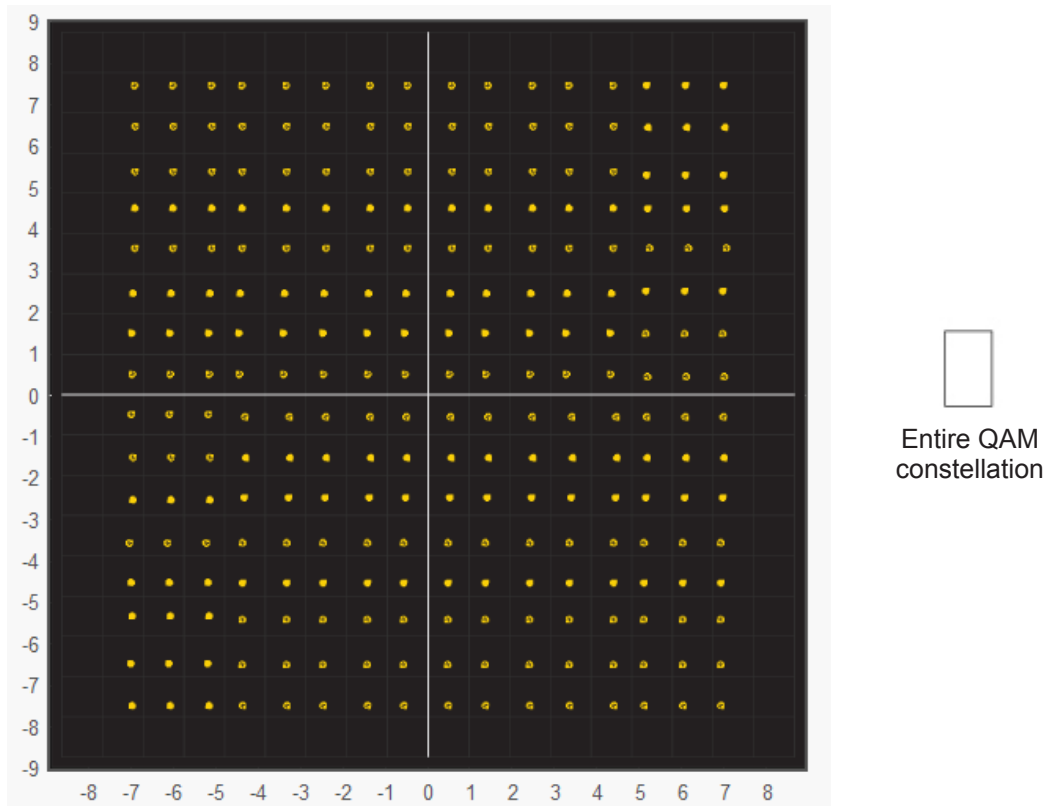

**Fig. 4-21, Rectangular vs. Square (I-Q Imbalance) and Entire Constellation Shape**

4.0 Web Interface, continued

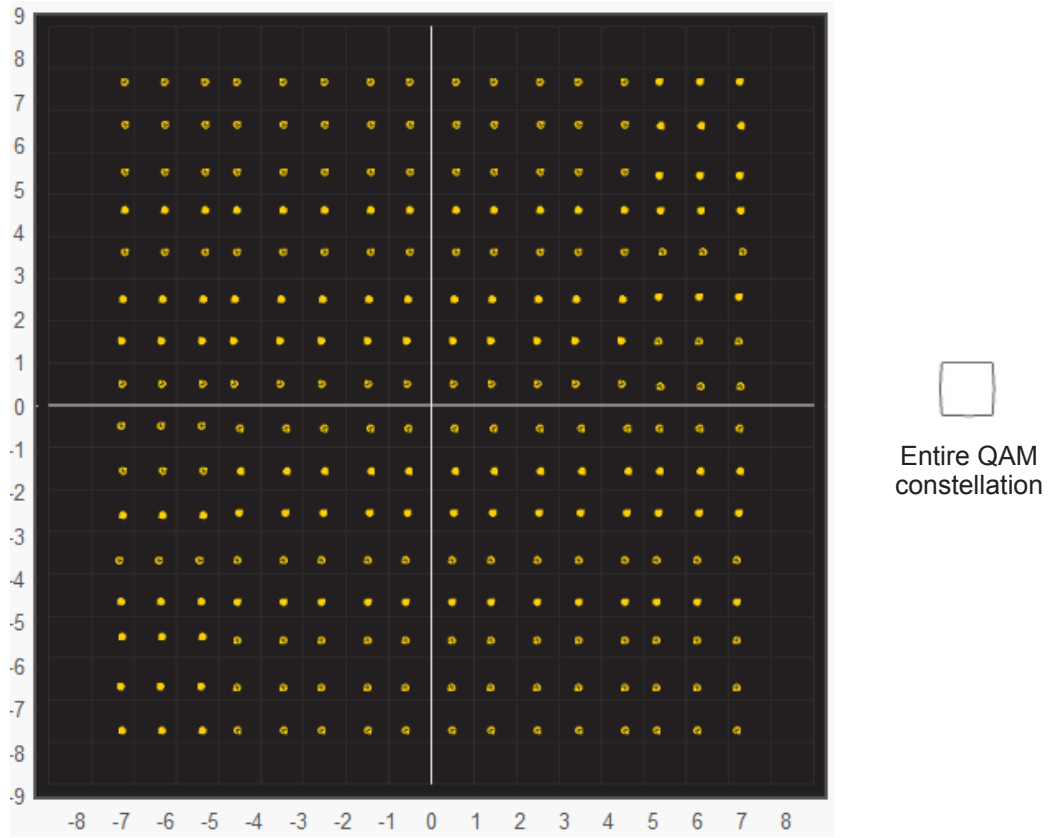

Fig. 4-22, Corners Squeezed to Center (Gain Compression) and Entire Constellation Shape

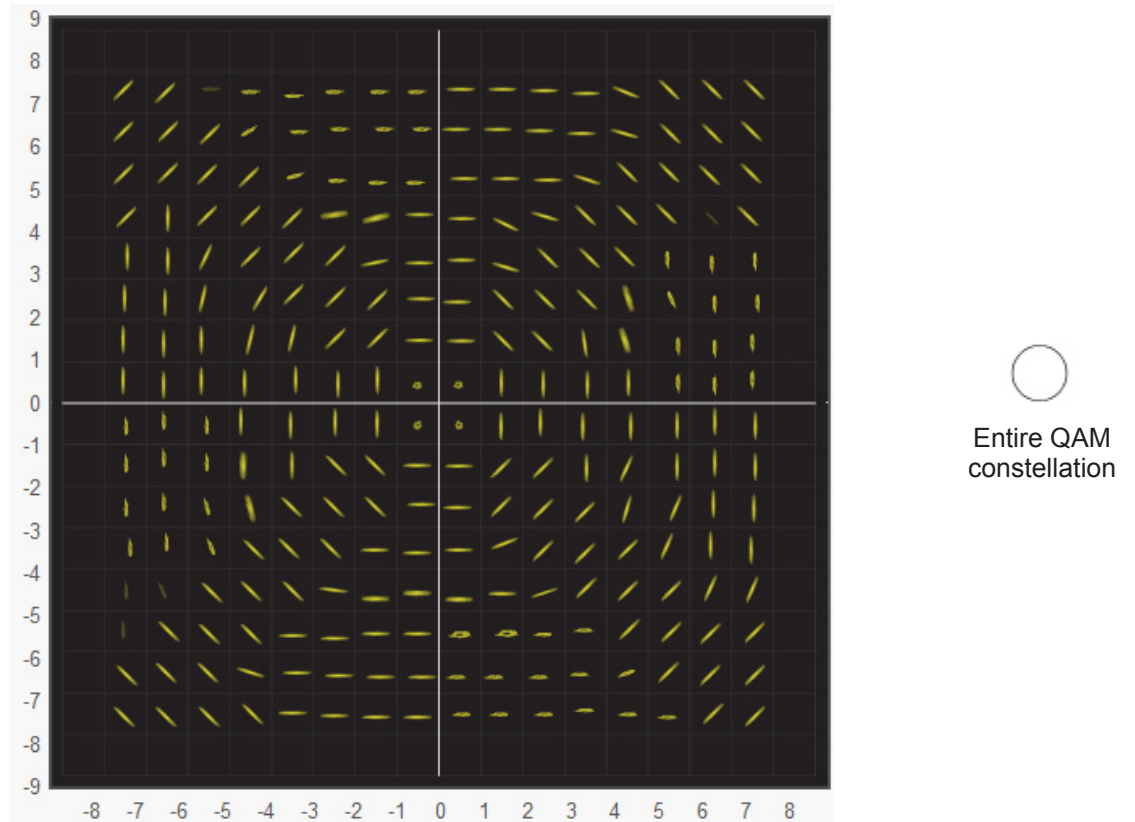

Fig. 4-23, Circular Smear (Phase Noise) and Entire Constellation Shape

#### 4.0 Web Interface, continued

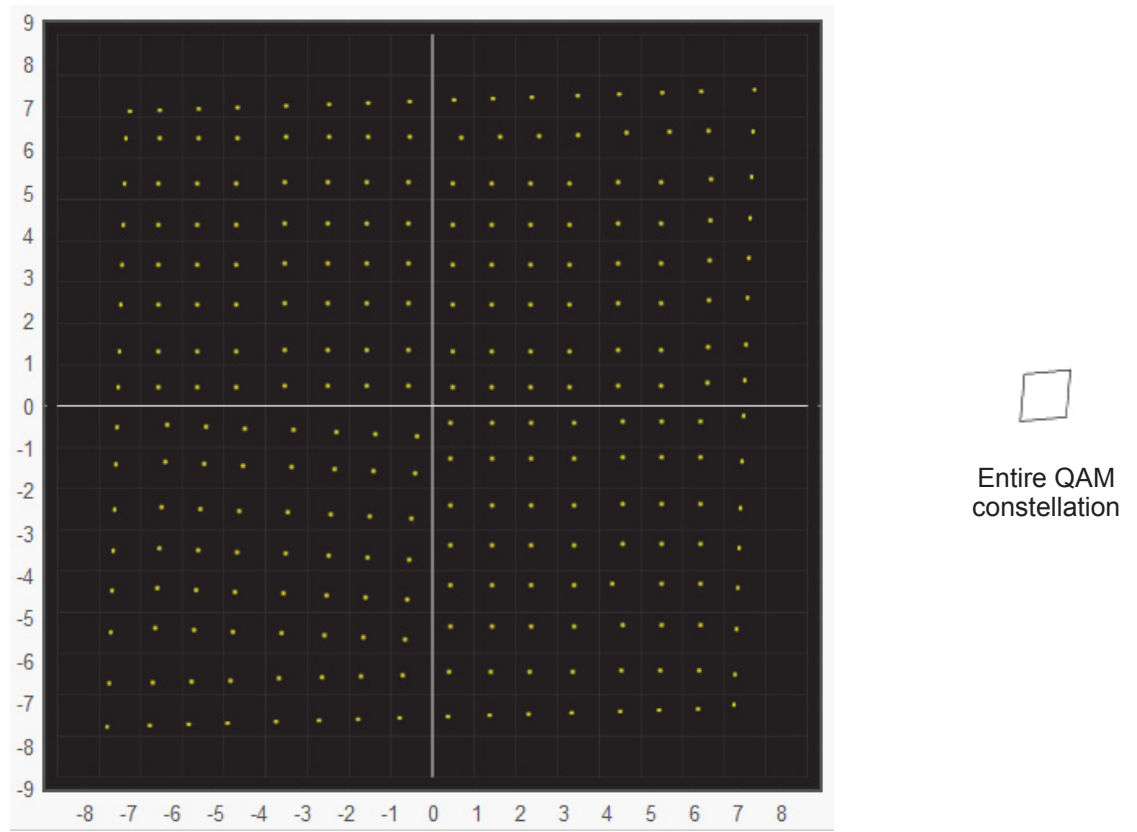

Fig. 4-24, Twisted or Skewed (Quadrature Distortion) and Entire Constellation Shape

## 4.0 Web Interface, continued

### 4.11.3 Microreflections Tool

The Microreflections page provides details about impairments on the DOCSIS network and the approximate distance(s) of the impairment(s). In order to provide the analysis and a display of possible impairments, this tool requires the Adaptive Equalization function to be enabled on the CMTS.

Navigate the mouse pointer to the Tools menu item and select “Microreflections” in the drop down menu to open the Microreflections page.

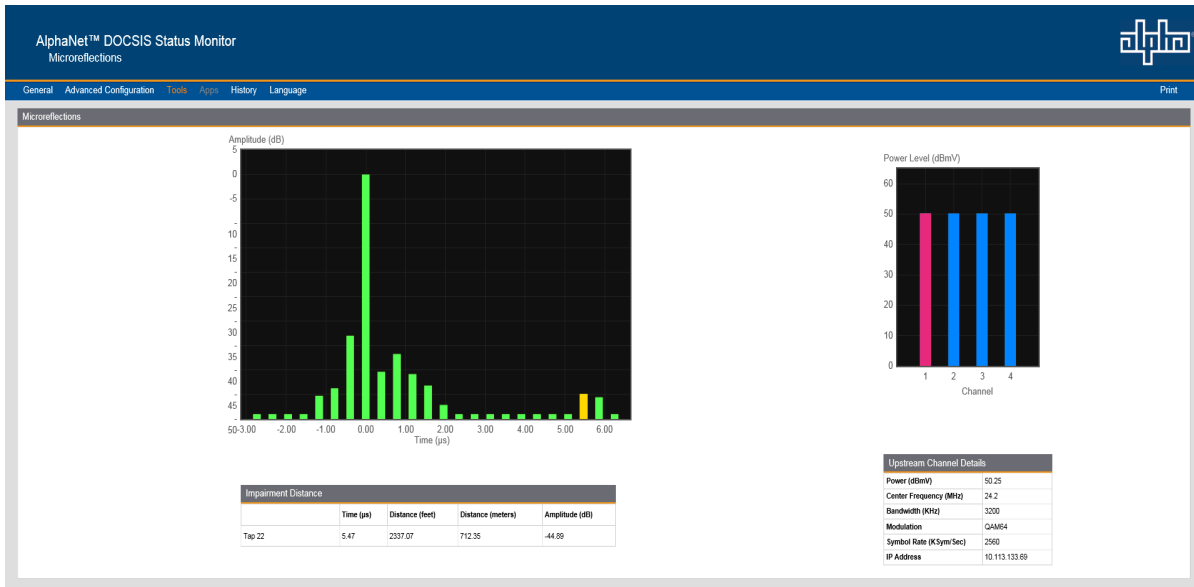

Fig. 4-25, Microreflections Tool

Click on a particular bar in the graph to display the details of the impairment such as time, distance (feet & meters) and amplitude. The selected bar will turn a slightly different shade of color compared to other bars in the graph.

## 4.0 Web Interface, continued

### 4.11.4 Spectrum Tool

Full Range Display Spanning 0 - 1005MHz, the Spectrum page provides a detailed, full-band capture analysis of the DOCSIS Channels for the DM3.0 Series Transponder. This tool assists in identifying and troubleshooting common impairments throughout the range of DOCSIS Channels. Navigate to the Tools menu item and select “Spectrum” in the drop down menu to open the Spectrum page.

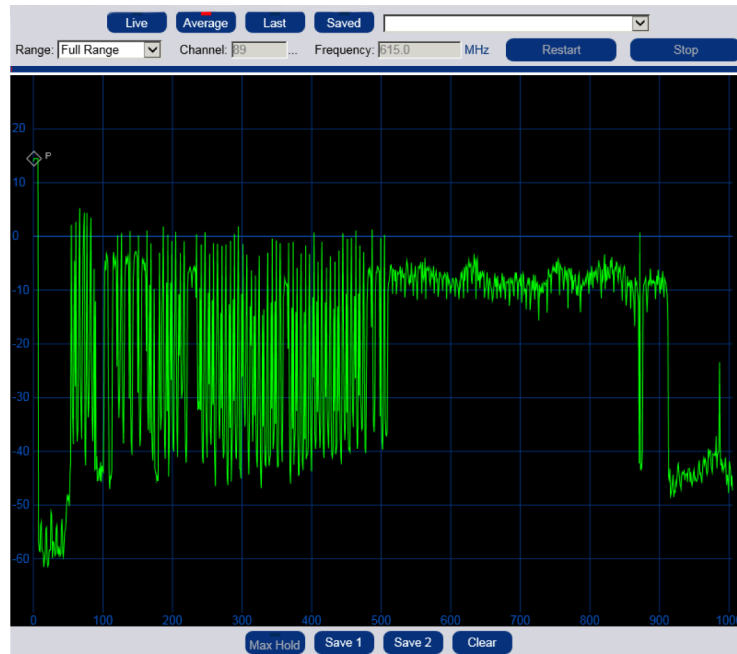

Fig. 4-26, Spectrum Tool

| Spectrum Tool Features    |               |   |
|---------------------------|---------------|---|
| Feature                   | Type          | Function  |
| Live                      | Button        | This provides a live view of the spectrum data.   |
| Average                   | Button        | This displays spectral data averaged from the last several background captures.   |
| Last                      | Button        | This displays the last capture.   |
| Saved                     | Button        | This displays the saved capture.  |
| Aggregate Minimum/Maximum | Dropdown Menu | This drop down menu allows the user to choose between displaying the aggregate minimum and aggregate maximum of the RF samples. |
| Range                     | Dropdown Menu | This drop down menu allows the user to select the window's span of measurement - Full, 3 Channel, or 1 Channel.                 |
| Channel                   | Data          | The channel number in the center of the display.  |
| Frequency                 | Data          | The frequency (in MHz) in the center of the display.  |
| Restart                   | Button        | This restarts the spectrum display.   |
| Stop                      | Button        | This stops the spectrum display from refreshing.  |
| Max Hold                  | Button        | This will mark the highest power seen. (Only applies to the “Live” view.)   |
| Save 1                    | Button        | Saves the current trace (1) and display.  |
| Save 2                    | Button        | Saves the current trace (2) and display.  |
| Clear                     | Button        | This clears the Max Hold, Save 1 and Save 2 traces.   |

Table 4-3, Spectrum Tool Buttons

## 4.0 Web Interface, continued

The tables on the right of the Spectrum page detail the X-Axis (Frequency), the Y-Axis (Amplitude), and the settings for the Spectrum display.

| Frequency            |                          |
|----------------------|--------------------------|
| Center Frequency     | 502.5 MHz                |
| Span                 | 1005 MHz                 |
| Start Frequency      | 0 MHz                    |
| Stop Frequency       | 1005 MHz                 |
| Resolution Bandwidth | 1 MHz                    |
| Amplitude            |                          |
| Maximum              | 30 dBmV                  |
| Minimum              | -70 dBmV                 |
| Measurements         |                          |
| Peak                 | 2.95 dBmV                |
| Peak Position        | 371.72 MHz               |
| Marker 1             | <input type="text"/> MHz |
| Power                |                          |
| Marker 2             | <input type="text"/> MHz |
| Power                |                          |
| Δ Frequency          |                          |
| Δ Power              |                          |

Fig. 4-27, Spectrum Tables

| Spectrum Tool Features     |  |
|----------------------------|--|
| Feature                    | Function   |
| Frequency (X-Axis)         |  |
| Center Frequency (MHz)     | The frequency in the center of the display.  |
| Span (MHz)                 | The range of frequencies in the display.   |
| Start Frequency (MHz)      | The frequency at the left end of the display.  |
| Stop Frequency (MHz)       | The frequency at the right end of the display.   |
| Resolution Bandwidth (MHz) | The frequency range represented by each point on the spectral display.                                       |
| Amplitude (Y-Axis)         |  |
| Maximum (dBmV)             | Enter a maximum power level in dBmV to control the scale of the Y-axis on the display.                       |
| Minimum (dBmV)             | Enter a minimum power level in dBmV to control the scale of the Y-axis on the display.                       |
| Measurements               |  |
| Peak (dBmV)                | The highest power level shown on the display. The reported value is dependant upon the Resolution Bandwidth. |
| Peak Position (MHz)        | The approximate frequency with the highest power level on the display.                                       |
| Marker 1 (MHz)             | Enter a frequency in MHz to see it's respective power level.   |
| Power (dBmV)               | The power level for the previously entered frequency.  |
| Marker 2 (MHz)             | Enter a frequency in Mhz to see it's repsective power level.   |
| Power (dBmV)               | The power level for the previously entered frequency.  |
| ▲ Frequency (MHz)          | The difference in frequency between the two markers.   |
| ▲ Power (dBmV)             | The difference in power between the two markers.   |

Table 4-4, Spectrum Table Details

## 4.0 Web Interface, continued

### 4.12 Viewing AlphaApps Information via the Web Page

The status of the optional AlphaApps Card may be viewed by navigating to the AlphaApps selection on the Apps menu of the DM3.0 Series Web page. Status and firmware version are typical parameters listed for this installed component of the power supply. A Configure/Save button is available for manually setting the Application Clock. Refer to Section 4.3.1, Web Interface Security Levels for User Name and Security Password.

The Utility section of the Web page displays current AC Line Status and Utility performance status. The utility event monitor tracks typical power events such as outages, sags, surges, and frequency in a tabular format for ease of viewing.

The screenshot displays the AlphaNet™ DOCSIS Status Monitor web interface. The top navigation bar includes 'General', 'Advanced Configuration', 'Tools', 'Apps', 'History', and 'Language'. The 'Alpha Apps' section shows the 'Application Clock' set to 'CMTS time will overwrite manually set time' with a 'Configure' button. Below this, the 'System Components' section lists 'Device 1'. The 'AppCard Status' is 'Not Installed' and the 'App Card Firmware Version' is blank. The 'Utility' section shows 'AC Line Status' as 'OK' and 'Input Voltage (V)' as '122.40'. The 'Utility Performance Current Status' is 'Not Installed'. The 'Utility Record Start (YYYY-MM-DD)' is '1970-01-01'. The 'Utility Events' section is a table with columns for 'Outages', 'Sags', 'Surges', and 'Frequency', showing various event duration and count metrics.

| Alpha Apps                         |                      |  |  |                |
|------------------------------------|----------------------|--|--|----------------|
| Application Clock                  | <input type="text"/> | <input type="button" value="Configure"/> | CMTS time will overwrite manually set time |                |
| <b>System Components</b>           |                      |  |  |                |
| Device 1                           |                      |  |  |                |
| AppCard Status                     | Not Installed        |  |  |                |
| App Card Firmware Version          |                      |  |  |                |
| Utility                            |                      |  |  |                |
| AC Line Status                     | OK                   |  |  |                |
| Input Voltage (V)                  | 122.40               |  |  |                |
| Utility Performance Current Status | Not Installed        |  |  |                |
| Utility Record Start (YYYY-MM-DD)  | 1970-01-01           |  |  |                |
| Utility Events                     |                      |  |  |                |
|                                    | Outages              | Sags                                     | Surges                                     | Frequency      |
| Current Event Duration             | 00h:00m:00s          | 00h:00m:00s                              | 00h:00m:00s                                | 00h:00m:00s    |
| Lifetime Number of Events          | 0                    | 0  | 0  | 0              |
| Lifetime Duration of Events        | 0d:00h:00m:00s       | 0d:00h:00m:00s                           | 0d:00h:00m:00s                             | 0d:00h:00m:00s |
| Lifetime Maximum Event Duration    | 00h:00m:00s          | 00h:00m:00s                              | 00h:00m:00s                                | 00h:00m:00s    |
| 24 Hour Number of Events           | 0                    | 0  | 0  | 0              |
| 24 Hour Average Event Duration     | 00h:00m:00s          | 00h:00m:00s                              | 00h:00m:00s                                | 00h:00m:00s    |
| 24 Hour Maximum Event Duration     | 00h:00m:00s          | 00h:00m:00s                              | 00h:00m:00s                                | 00h:00m:00s    |
| 24 Hour Minimum Event Duration     | 00h:00m:00s          | 00h:00m:00s                              | 00h:00m:00s                                | 00h:00m:00s    |

Fig. 4-28, AlphaApps and Utility Status Parameters

## 4.13 Battery Management

Technician ID, battery conductance measurements, battery model and battery manufacturing dates can be manually entered via the Web page interface. Navigate to the Battery Management selection on the Apps menu Web page to access the battery management details. A Configure/Cancel/Save button is available for the configurable settings on this page. Click the Configure button to enable the configuration/editing mode, then click the Save button to save all the edits. For User Name and Password refer to Section 4.3.1, Web Interface Security Levels.

AlphaNet™ DOCSIS Status Monitor  
Battery Management

---

General   Advanced Configuration   **Apps**   History   Language
Print

**Advanced Battery Configuration**

|                                       |  |  |                                |
|---------------------------------------|--|--|--------------------------------|
| Configure / Cancel / Save             | <input type="button" value="Save"/> <input type="button" value="Cancel"/>      |  |                                |
| Technician ID (≤999)                  | <input type="text" value="0"/>   |  |                                |
| Heater Mat Installed                  | <input checked="" type="radio"/> Not Installed <input type="radio"/> Installed |  |                                |
| Battery String Runtime Remaining      | <input <="" calculating="" td="" type="button" value="?"  =""/>                |  |                                |
| Battery Life Remaining                | <input checked="" type="checkbox"/> > 5 Years                                  |  |                                |
| Number of Battery Strings             | <input type="text" value="2"/> ▼   |  |                                |
| Battery Model                         | <input type="text" value="4.0HP"/> ▼   |  |                                |
| Charger Accept Voltage (V/C)          | <input type="text" value="2.35"/>  |  |                                |
| Charger Float Voltage (V/C)           | <input type="text" value="2.25"/>  |  |                                |
| Charger Refresh Voltage (V/C)         | <input type="text" value="2.45"/>  |  |                                |
| Battery Capacity (AH)                 | <input type="text" value="114"/>   |  |                                |
| Charger Temperature Compensation (mV) | <input type="text" value="4.00"/>  |  |                                |
| End of Discharge Type                 | <input type="text" value="String"/> ▼  |  |                                |
| End of Discharge (V/C)                | <input type="text" value="1.70"/>  |  |                                |
| Date of Last Conductance Measurement  | <input type="text" value="01/2000"/>   |  |                                |
|                                       | Conductance Measurement Entry<br>(siemens)                                     | Last Conductance Measurement<br>(siemens)<br>Adjusted for Temperature Compensation | Manufactured Date<br>(MM/YYYY) |
| String A Battery 1                    | <input type="text"/>   | 0  | -- ▼ / -- ▼                    |
| String A Battery 2                    | <input type="text"/>   | 0  | -- ▼ / -- ▼                    |
| String A Battery 3                    | <input type="text"/>   | 0  | -- ▼ / -- ▼                    |
| String B Battery 1                    | <input type="text"/>   | 0  | -- ▼ / -- ▼                    |
| String B Battery 2                    | <input type="text"/>   | 0  | -- ▼ / -- ▼                    |
| String B Battery 3                    | <input type="text"/>   | 0  | -- ▼ / -- ▼                    |

Fig. 4-29, Battery Management



## 4.0 Web Interface, continued

Click the Battery Model drop down menu to view a selection of common battery models. If the installed battery model is not listed for your particular configuration, then select Other for the model type. Click the Save button to save all edits.

| Advanced Battery Configuration        |   |  |                             |
|---------------------------------------|---|--|-----------------------------|
| Configure / Cancel / Save             | Save Cancel   |  |                             |
| Technician ID (≤999)                  | 0   |  |                             |
| Heater Mat Installed                  | <input checked="" type="radio"/> Not Installed <input type="radio"/> Installed  |  |                             |
| Battery String Runtime Remaining      | Calculating   |  |                             |
| Battery Life Remaining                | <input checked="" type="checkbox"/> > 5 Years   |  |                             |
| Number of Battery Strings             | 2   |  |                             |
| Battery Model                         | 4.0HP   |  |                             |
| Charger Accept Voltage (V/C)          | <div style="border: 1px solid black; padding: 2px;">                     Other<br/>                     70HPL<br/>                     85GXL<br/>                     115HPL<br/>                     165GXL<br/>                     180GXL<br/>                     195GOLD<br/>                     195GXL<br/>                     210GXL<br/>                     220GXL<br/>                     220HPL<br/>                     220GOLD<br/>                     3.5HP<br/>                     4.0HP<br/>                     170XLT                 </div> |  |                             |
| Charger Float Voltage (V/C)           |   |  |                             |
| Charger Refresh Voltage (V/C)         |   |  |                             |
| Battery Capacity (AH)                 |   |  |                             |
| Charger Temperature Compensation (mV) |   |  |                             |
| End of Discharge Type                 |   |  |                             |
| End of Discharge (V/C)                | 1.70  |  |                             |
| Date of Last Conductance Measurement  | 01/2000   |  |                             |
|                                       | Conductance Measurement Entry (siemens)   | Last Conductance Measurement (siemens) Adjusted for Temperature Compensation | Manufactured Date (MM/YYYY) |
| String A Battery 1                    | <input type="text"/>  | 0  | -- / --                     |
| String A Battery 2                    | <input type="text"/>  | 0  | -- / --                     |
| String A Battery 3                    | <input type="text"/>  | 0  | -- / --                     |
| String B Battery 1                    | <input type="text"/>  | 0  | -- / --                     |
| String B Battery 2                    | <input type="text"/>  | 0  | -- / --                     |
| String B Battery 3                    | <input type="text"/>  | 0  | -- / --                     |

Fig. 4-30, Battery Model Selection

## 4.14 Viewing Power Supply Event and Configuration Logs

Navigate to the History menu for viewing the power supply event and configuration logs. The System Logs provide a snapshot of the five most recent entries of the power supply event log and the power supply configuration log. For a more comprehensive list, click on the link or select from the History menu for the desired log file.

AlphaNet™ DOCSIS Status Monitor  
History
alpha

---

General   Advanced Configuration   Apps   **History**   Language
Print

**System Logs**

Time Offset:  ▼

[Power Supply Event Log](#)

| Event | Time/Date Stamp  | SNMP Table Index | Data Field  |
|-------|------------------|------------------|---|
| 1     | 04/01/2013 13:38 | 727              | [APP-1] TIME SET 04/01/13 21:38:10 -> 04/01/13 21:38:53 |
| 2     | 04/01/2013 09:25 | 726              | [APP-1] ALARM CLEARED:SAG-1 A BAL STAGE=MODERATE        |
| 3     | 04/01/2013 09:05 | 725              | [APP-1] WARNING:SAG-1 A BAL STAGE=SEVERE                |
| 4     | 04/01/2013 09:04 | 724              | [APP-1] ALARM CLEARED:SAG-1 A BAL STAGE=MODERATE        |
| 5     | 04/01/2013 09:01 | 723              | [APP-1] WARNING:SAG-1 A BAL STAGE=SEVERE                |

[Power Supply Configuration Log](#)

| Event | Time/Date Stamp  | SNMP Table Index | Data Field                                  |
|-------|------------------|------------------|---|
| 1     | 03/19/2013 12:59 | 46               | [APP-1] CM MAC CHANGED TO 00:90:EA:00:74:42 |
| 2     | 03/01/2013 08:06 | 45               | [APP-1] SAG FW VERSION SAG FW V1.05.0       |
| 3     | 03/01/2013 08:06 | 44               | [APP-1] DOC FW VERSION DOC FW V1.02.0       |
| 4     | 03/01/2013 08:06 | 43               | [APP-1] MICRO FW VERSION XM3 FW V1.06.0     |
| 5     | 03/01/2013 08:06 | 42               | [APP-1] EMI PART NUMBER EMI P/N NOT SET     |

[Battery Event Log](#)

| Event | Time/Date Stamp  | SNMP Table Index | Data Field                         |
|-------|------------------|------------------|------------------------------------|
| 1     | 03/31/2013 16:11 | 5                | [APP-1] 13 61443682 21 0 0 0 4 4 0 |
| 2     | 03/25/2013 16:10 | 4                | [APP-1] 13 61443688 17 0 0 0 4 4 0 |
| 3     | 03/19/2013 14:09 | 3                | [APP-1] 13 61443695 8 0 0 0 4 4 0  |
| 4     | 03/13/2013 14:06 | 2                | [APP-1] 13 61443701 8 0 0 0 4 4 0  |
| 5     | 03/07/2013 14:05 | 1                | [APP-1] 13 61443707 5 0 0 0 4 4 0  |

Fig. 4-31, System Log

#### 4.0 Web Interface, continued

A Time Offset selection is available on each log table for selection of your current time offset from Greenwich Mean Time (GMT). Select the time offset that best matches your location to enable the local time in the log tables. Refer to Table 4-4 for a list of time zone offsets and relative locations.

| <b>Time Offset Values and Location References (offset +/- GMT)</b> |                           |
|--|---------------------------|
| <b>GMT Offset</b>  | <b>Location Reference</b> |
| +12  | Auckland                  |
| +11  | Magadan                   |
| +10  | Sydney                    |
| +9.5   | Adelaide                  |
| +9   | Seoul                     |
| +8   | Hong Kong                 |
| +7   | Bangkok                   |
| +6.5   | Yangon                    |
| +6   | Astana                    |
| +5.5   | Sri Lanka                 |
| +5   | Islamabad                 |
| +4.5   | Kabul                     |
| +4   | Abu Dhabi                 |
| +3.5   | Tehran                    |
| +3   | Moscow                    |
| +2   | Jerusalem                 |
| +1   | Berlin                    |
| <b>GMT</b>   | London                    |
| -1   | Azores                    |
| -2   | Mid-Atlantic              |
| -3   | Buenos Aires              |
| -3.5   | Newfoundland              |
| -4   | Santiago                  |
| -4.5   | Caracas                   |
| -5   | Eastern Time              |
| -6   | Central Time              |
| -7   | Mountain Time             |
| -8   | Pacific Time              |
| -9   | Alaska                    |
| -10  | Hawaii                    |
| -11  | Midway Is                 |
| -12  | Eniwetok                  |

**Table 4-5, Time Offset Values and Location References (offset +/- GMT)**

## 4.0 Web Interface, continued

The Power Supply event log records events that occur in the normal course of daily power supply operation such as IP address changes, alarms, power outages, etc. A Time Offset selection can be configured to display the events in the specified time zone. The event log data may be downloaded by clicking on the Download CSV (comma-separated values) button located at the bottom left of the page.

### **NOTICE:**

The AlphaApps card will store a maximum of 768 event log entries that can be reviewed in the CSV file. The Power Supply Event Log Web page will display a maximum of 512 event log entries. The event log entries are displayed in groups of 50. Navigate to particular events by selecting one of the numbered entry links listed at the bottom of the page.

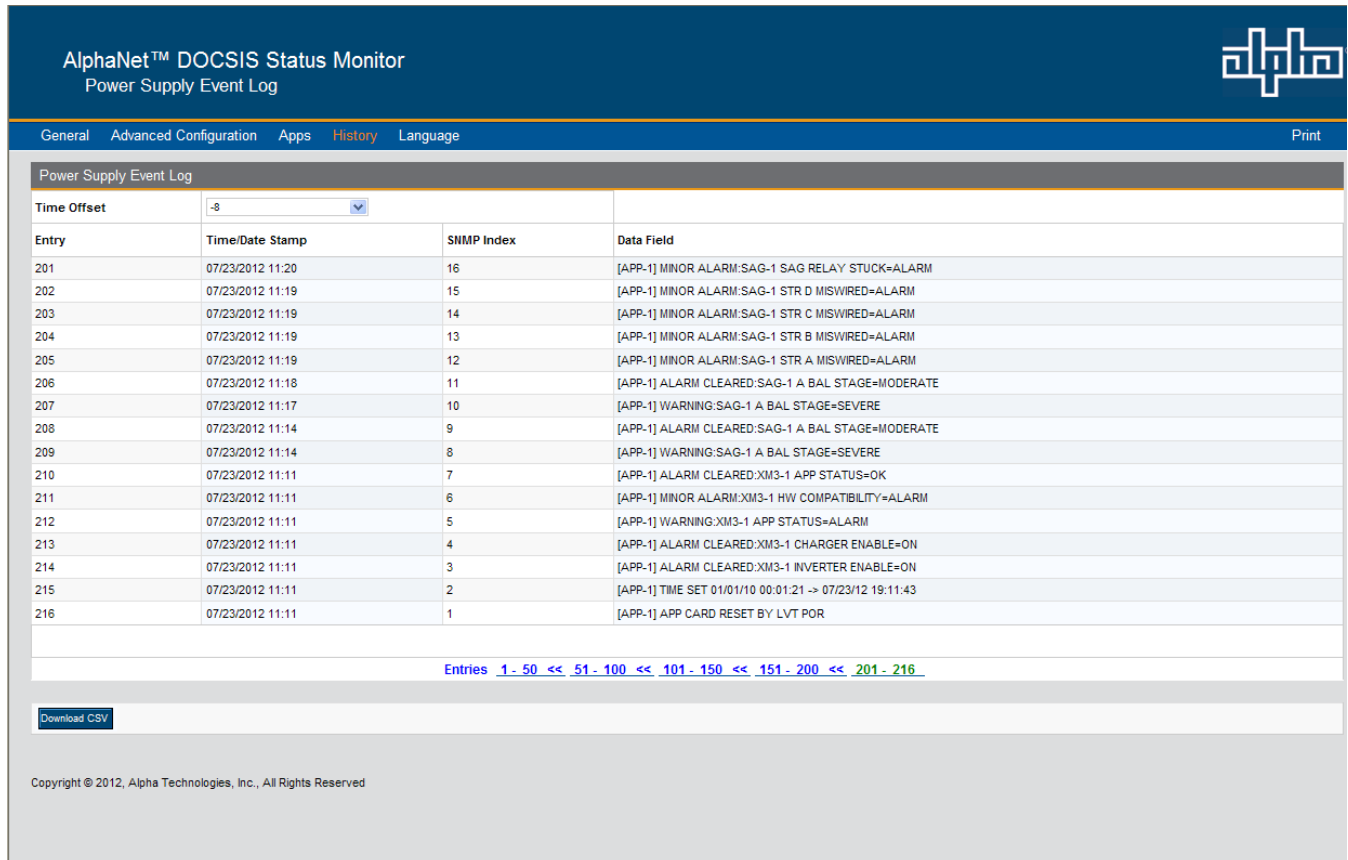

AlphaNet™ DOCSIS Status Monitor  
Power Supply Event Log

General Advanced Configuration Apps History Language Print

Power Supply Event Log

Time Offset: -8

| Entry | Time/Date Stamp  | SNMP Index | Data Field  |
|-------|------------------|------------|---|
| 201   | 07/23/2012 11:20 | 16         | [APP-1] MINOR ALARM:SAG-1 SAG RELAY STUCK=ALARM         |
| 202   | 07/23/2012 11:19 | 15         | [APP-1] MINOR ALARM:SAG-1 STR D MISWIRED=ALARM          |
| 203   | 07/23/2012 11:19 | 14         | [APP-1] MINOR ALARM:SAG-1 STR C MISWIRED=ALARM          |
| 204   | 07/23/2012 11:19 | 13         | [APP-1] MINOR ALARM:SAG-1 STR B MISWIRED=ALARM          |
| 205   | 07/23/2012 11:19 | 12         | [APP-1] MINOR ALARM:SAG-1 STR A MISWIRED=ALARM          |
| 206   | 07/23/2012 11:18 | 11         | [APP-1] ALARM CLEARED:SAG-1 A BAL STAGE=MODERATE        |
| 207   | 07/23/2012 11:17 | 10         | [APP-1] WARNING:SAG-1 A BAL STAGE=SEVERE                |
| 208   | 07/23/2012 11:14 | 9          | [APP-1] ALARM CLEARED:SAG-1 A BAL STAGE=MODERATE        |
| 209   | 07/23/2012 11:14 | 8          | [APP-1] WARNING:SAG-1 A BAL STAGE=SEVERE                |
| 210   | 07/23/2012 11:11 | 7          | [APP-1] ALARM CLEARED:XM3-1 APP STATUS=OK               |
| 211   | 07/23/2012 11:11 | 6          | [APP-1] MINOR ALARM:XM3-1 HW COMPATIBILITY=ALARM        |
| 212   | 07/23/2012 11:11 | 5          | [APP-1] WARNING:XM3-1 APP STATUS=ALARM                  |
| 213   | 07/23/2012 11:11 | 4          | [APP-1] ALARM CLEARED:XM3-1 CHARGER ENABLE=ON           |
| 214   | 07/23/2012 11:11 | 3          | [APP-1] ALARM CLEARED:XM3-1 INVERTER ENABLE=ON          |
| 215   | 07/23/2012 11:11 | 2          | [APP-1] TIME SET 01/01/10 00:01:21 -> 07/23/12 19:11:43 |
| 216   | 07/23/2012 11:11 | 1          | [APP-1] APP CARD RESET BY LVT POR                       |

Entries [1 - 50 <<](#) [51 - 100 <<](#) [101 - 150 <<](#) [151 - 200 <<](#) [201 - 216](#)

[Download CSV](#)

Copyright © 2012, Alpha Technologies, Inc., All Rights Reserved

Fig. 4-32, Power Supply Event Log

## 4.0 Web Interface, continued

The Power Supply Configuration Log, accessible via the History drop down menu, contains events that occur infrequently or only once, such as transponder configuration (firmware version), CM MAC address, Inverter Module serial number, etc.

The configuration log data may be downloaded by clicking on the Download CSV button. The Configuration Log will store a maximum of 255 entries.

AlphaNet™ DOCSIS Status Monitor  
Power Supply Configuration Log

General   Advanced Configuration   Apps   **History**   Language
Print

Power Supply Configuration Log

Time Offset:

| Entry | Time/Date Stamp  | SNMP Index | Data Field                                  |
|-------|------------------|------------|---|
| 51    | 07/23/2012 11:12 | 36         | [APP-1] EMI PART NUMBER EMI P/N NOT SET     |
| 52    | 07/23/2012 11:12 | 35         | [APP-1] EMI SERIAL NUMBER EMI S/N NOT SET   |
| 53    | 07/23/2012 11:12 | 34         | [APP-1] SAG PART NUMBER 7048742000127 --    |
| 54    | 07/23/2012 11:12 | 33         | [APP-1] SAG SERIAL NUMBER A011137F10E0039   |
| 55    | 07/23/2012 11:12 | 32         | [APP-1] DOC PART NUMBER DOC P/N NOT SET     |
| 56    | 07/23/2012 11:12 | 31         | [APP-1] DOC SERIAL NUMBER DOC S/N NOT SET   |
| 57    | 07/23/2012 11:12 | 30         | [APP-1] MICRO PCBA PART # MICRO P/N NOT SET |
| 58    | 07/23/2012 11:12 | 29         | [APP-1] MICRO PCBA SER # MICRO S/N NOT SET  |
| 59    | 07/23/2012 11:12 | 28         | [APP-1] INV PCBA PART # INV P/N NOT SET     |
| 60    | 07/23/2012 11:12 | 27         | [APP-1] INV PCBA SER NUMBER INV S/N NOT SET |
| 61    | 07/23/2012 11:12 | 26         | [APP-1] INV MOD SERV CODE 2 IM SERVICE 2    |
| 62    | 07/23/2012 11:12 | 25         | [APP-1] INV MOD SERV CODE 1 IM SERVICE 1    |
| 63    | 07/23/2012 11:12 | 24         | [APP-1] INV MOD DEVIATION IM RESERVED       |
| 64    | 07/23/2012 11:12 | 23         | [APP-1] INV MODULE CTO 2: 02--1R4AP         |
| 65    | 07/23/2012 11:11 | 22         | [APP-1] INV MODULE CTO 1: XM31269F183CU     |
| 66    | 07/23/2012 11:11 | 21         | [APP-1] INV MOD PART NUMBER IM P/N NOT SET  |
| 67    | 07/23/2012 11:11 | 20         | [APP-1] INV MOD SER NUMBER IM S/N NOT SET   |
| 68    | 07/23/2012 11:11 | 19         | [APP-1] FERRO CAP CODE OIL CAP NOT SET      |
| 69    | 07/23/2012 11:11 | 18         | [APP-1] XFMR PART NUMBER XFMR P/N NOT SET   |
| 70    | 07/23/2012 11:11 | 17         | [APP-1] XFMR SERIAL NUMBER XFMR S/N NOT SET |
| 71    | 07/23/2012 11:11 | 16         | [APP-1] PDB PART NUMBER PDB P/N NOT SET     |
| 72    | 07/23/2012 11:11 | 15         | [APP-1] PDB SERIAL NUMBER PDB S/N NOT SET   |
| 73    | 07/23/2012 11:11 | 14         | [APP-1] XFMR MOD SRV CODE 2 TM SERVICE 2    |
| 74    | 07/23/2012 11:11 | 13         | [APP-1] XFMR MOD SRV CODE 1 TM SERVICE 1    |
| 75    | 07/23/2012 11:11 | 12         | [APP-1] XFMR MOD DEVIATION XM31269F183C-    |
| 76    | 07/23/2012 11:11 | 11         | [APP-1] XFMR MODULE CTO 2: TM RESERVED      |
| 77    | 07/23/2012 11:11 | 10         | [APP-1] XFMR MODULE CTO 1: 02011R4AP        |
| 78    | 07/23/2012 11:11 | 9          | [APP-1] XFMR MOD PART # TM P/N NOT SET      |
| 79    | 07/23/2012 11:11 | 8          | [APP-1] XFMR MOD SER NUMBER TM S/N NOT SET  |
| 80    | 07/23/2012 11:11 | 7          | [APP-1] IPU PART NUMBER XM3-918-HP          |
| 81    | 07/23/2012 11:11 | 6          | [APP-1] BTQ FW VERSION BTQ FW NOT SET       |
| 82    | 07/23/2012 11:11 | 5          | [APP-1] APP CARD PART # APP P/N NOT SET     |
| 83    | 07/23/2012 11:11 | 4          | [APP-1] UTL FW V1.00.0                      |
| 84    | 07/23/2012 11:11 | 3          | [APP-1] APP CARD SERIAL NO. APP S/N NOT SET |
| 85    | 07/23/2012 11:11 | 2          | [APP-1] UTILITY STARTED 07/23/12 19:11:44   |
| 86    | 07/23/2012 11:11 | 1          | [APP-1] AlphaAPP V1.01.0 K                  |

Entries [1 - 50](#) << [51 - 86](#)

[Download CSV](#)

Copyright © 2012, Alpha Technologies, Inc., All Rights Reserved

Fig. 4-33, Power Supply Configuration Log

## 4.0 Web Interface, continued

### 4.15 Battery Event Log

The Battery Event Log can be accessed by navigating to the History menu. The Battery Event Log records the battery conductance measurements and battery manufacturing dates. Download the Battery Event Log data by clicking the Download CSV button. The Battery Event Log will store a maximum of 1024 entries, then it will automatically roll over.

| Entry | Time/Date Stamp  | Index | Data Field                |
|-------|------------------|-------|---------------------------|
| 1     | 07/31/2012 14:54 | 24    | [APP-2] BATT A1 MFG 7/11  |
| 2     | 07/31/2012 14:52 | 23    | [APP-2] BATT A3 MHOS 1157 |
| 3     | 07/31/2012 14:52 | 22    | [APP-2] BATT A3 MFG 11/11 |
| 4     | 07/31/2012 14:52 | 21    | [APP-2] BATT A2 MHOS 1081 |
| 5     | 07/31/2012 14:52 | 20    | [APP-2] BATT A1 MFG 9/11  |
| 6     | 07/31/2012 14:52 | 19    | [APP-2] BATT A1 MHOS 972  |
| 7     | 07/24/2012 13:27 | 18    | [APP-2] BATT A3 MFG 12/11 |
| 8     | 07/24/2012 13:27 | 17    | [APP-2] BATT A3 MHOS 1134 |
| 9     | 07/24/2012 13:27 | 16    | [APP-2] BATT A2 MFG 11/11 |
| 10    | 07/24/2012 13:27 | 15    | [APP-2] BATT A2 MHOS 1039 |
| 11    | 07/24/2012 13:27 | 14    | [APP-2] BATT A1 MHOS 945  |
| 12    | 07/24/2012 13:27 | 13    | [APP-2] BATT A1 MFG 10/11 |
| 13    | 07/31/2012 14:54 | 12    | [APP-1] BATT A1 MFG 7/11  |
| 14    | 07/31/2012 14:52 | 11    | [APP-1] BATT A3 MHOS 1157 |
| 15    | 07/31/2012 14:52 | 10    | [APP-1] BATT A3 MFG 11/11 |
| 16    | 07/31/2012 14:52 | 9     | [APP-1] BATT A2 MHOS 1081 |
| 17    | 07/31/2012 14:52 | 8     | [APP-1] BATT A1 MFG 9/11  |
| 18    | 07/31/2012 14:52 | 7     | [APP-1] BATT A1 MHOS 972  |
| 19    | 07/24/2012 13:27 | 6     | [APP-1] BATT A3 MFG 12/11 |
| 20    | 07/24/2012 13:27 | 5     | [APP-1] BATT A3 MHOS 1134 |
| 21    | 07/24/2012 13:27 | 4     | [APP-1] BATT A2 MFG 11/11 |
| 22    | 07/24/2012 13:27 | 3     | [APP-1] BATT A2 MHOS 1039 |
| 23    | 07/24/2012 13:27 | 2     | [APP-1] BATT A1 MHOS 945  |
| 24    | 07/24/2012 13:27 | 1     | [APP-1] BATT A1 MFG 10/11 |

Fig. 4-34, Battery Event Log

### 4.16 Viewing the Modem Event Log via the Web Page

View the transponder's event log by clicking the History drop down menu and select Modem Log. This will display the Docsdev Event Log. The log may be reset by clicking on the Reset Log button or the logged data may be downloaded by clicking on the Download CSV button.

| docsDevEvFirstTime       | docsDevEvLastTime        | docsDevEvCounts | docsDevEvLevel | docsDevEvId | docsDevEvText   |
|--------------------------|--------------------------|-----------------|----------------|-------------|---|
| Wed Dec 14 23:05:27 2011 | Wed Dec 14 23:06:30 2011 | 183             | Critical       | 84000100    | SYNC Timing Synchronization failure - Failed to acquire QAM/QPSK symbol timing  |
| Wed Dec 14 23:05:57 2011 | Wed Dec 14 23:05:57 2011 | 1               | Critical       | 84000200    | SYNC Timing Synchronization failure - Failed to acquire FEC framing   |
| Wed Dec 14 23:05:57 2011 | Wed Dec 14 23:05:57 2011 | 1               | Critical       | 82000400    | Received Response to Broadcast Maintenance Request, But no Unicast Maintenance opportunities received - T4 time out               |
| Wed Dec 14 23:08:50 2011 | Wed Dec 14 23:08:50 2011 | 1               | Warning        | 68000300    | DHCP WARNING - Non-critical field invalid in response ;CM-MAC=00:90:ea:00:30:8e;CMTS-MAC=00:00:ca:13:a6:2c;CM-QOS=1.0;CM-VER=2.0; |

Fig. 4-35, Docsdev Event Log Screen

# 5.0 Upgrading Firmware

## 5.1 Upgrading DM3.0 Series Transponder Modem Firmware

The firmware is upgraded using standard DOCSIS methods as defined in RFC4639.

There are two ways to upgrade the modem's firmware: By directly setting the appropriate MIB parameters in the docsDevSoftware branch, or by including the appropriate SNMP parameters and values in the modem's DOCSIS Configuration File, stored in the TFTP root directory.

Both methods are explained below.

### 5.1.1 Identifying the Modem and Obtaining Firmware Files

The cable modem firmware in the DM3.0 Series Transponder requires its own firmware and manufacturer's Code Verification Certificate (CVC file).

Contact Alpha Technologies to obtain the latest firmware and manufacturer's CVC files.

### 5.1.2 Modem Firmware Upgrade SNMP Parameters

| Modem Firmware Upgrade SNMP Parameters                     |                            |   |
|--|----------------------------|---|
| Parameter  | Type                       | Value   |
| docsDevSoftware<br>OID: 1.3.6.1.2.1.69.1.3                 | Object<br>Heading          | None  |
| docsDevSwServer<br>OID: 1.3.6.1.2.1.69.1.3.1.0             | IP Address                 | The IP address of the TFTP server from which the firmware will be downloaded. This OID has been deprecated, refer to docsDevSwServerAddress (OID:1.3.6.1.2.1.69.1.3.7.0).   |
| docDevSwFilename<br>OID: 1.3.6.1.2.1.69.1.3.2.0            | Octet String               | Set to the filename of the firmware file. Example: ["firmwareImage.bin"]  |
| docsDevSwAdminStatus<br>OID: 1.3.6.1.2.1.69.1.3.3.0        | Integer                    | 1 = Initiate upgrade (manual method)<br>2 = Upgrade on next reboot (Config File Method)<br>3 = Ignore update  |
| docsDevSwOperStatus<br>OID: 1.3.6.1.2.1.69.1.3.4.0         | Integer,<br>Read Only      | 1 = TFTP download is in progress<br>2 = Last upgrade was performed at reboot<br>3 = Last upgrade was initiated by setting docsDevSwAdminStatus to "1"<br>4 = Firmware upgrade failed<br>5 = Other   |
| docsDevSwCurrentVers<br>OID: 1.3.6.1.2.1.69.1.3.5.0        | Octet String,<br>Read Only | The current version of firmware installed in the modem  |
| docsDevSwServerAddressType<br>1.3.6.1.2.1.69.1.3.6.0       | Integer,<br>Read Only      | The type of address (IPv4, IPv6) of server used for upgrades  |
| docsDevSwServerAddress<br>OID: 1.3.6.1.2.1.69.1.3.7.0      | IP Address                 | The IP address of the server from which the firmware will be downloaded. A set of this object to an IPv4 address will result in also setting the value of docsDevSwServer to that address. If this object is set to an IPv6 address, docsDevSwServer is set to 0.0.0.0. If docsDevSwServer is set, this object is also set to that value. |
| docsDevSwServerTransportProtocol<br>1.3.6.1.2.1.69.1.3.8.0 | Integer,<br>Read Only      | The Transport protocol to be used for software upgrades:<br>1 = TFTP<br>2 = HTTP  |

**Table 5-1, Modem Firmware Upgrade SNMP Parameters**

## 5.0 Upgrading Firmware, continued

### 5.1.3 Upgrading Manually by Setting SNMP Parameters

1. Acquire the firmware and CVC files for your DM3.0 Series Transponder from Alpha Technologies.
2. Import the CVC into the modem's DOCSIS Configuration File (to create a Configuration File, see Section 3.3, The DOCSIS Configuration File).
3. Set the following MIB parameters using an SNMP MIB browser. For additional information regarding the SNMP MIB parameters, refer to the table in Section 5.1.2, Modem Firmware Upgrade SNMP Parameters.

| SNMP Parameters                                      |  |
|--|--|
| Parameter  | Value  |
| docsDevSwServerAddress<br>OID:1.3.6.1.2.1.69.1.3.7.0 | IP Address of the TFTP server (IPv4 or IPv6) |
| docsDevSwFilename<br>OID:1.3.6.1.2.1.69.1.3.2.0      | Firmware filename                            |
| docsDevSwAdminStatus<br>OID: 1.3.6.1.2.1.69.1.3.3.0  | 1 (Initiate Upgrade)                         |

**Table 5-2, SNMP Parameters**

The firmware upgrade will begin immediately. Monitor the upgrade status with the docsDevSwOperStatus MIB parameter, and verify the firmware version with the docsDevSwCurrentVers MIB parameter (refer to Table 5-1, Modem Firmware Upgrade SNMP Parameters). Once the firmware has been upgraded, the modem will automatically run the new version.

### 5.1.4 Upgrading via the DOCSIS Configuration File

DM3.0 Series Transponder firmware can be automatically upgraded using the DOCSIS Configuration File by adding the following docsDevSoftware SNMP parameters and the manufacturer's Code Verification Certificate (CVC).

| DOCSIS Configurations File Values                    |  |
|--|--|
| Parameter  | Value  |
| docsDevSwServerAddress<br>OID:1.3.6.1.2.1.69.1.3.7.0 | IP Address of TFTP server  |
| docsDevSwFilename<br>OID:1.3.6.1.2.1.69.1.3.2.0      | Firmware filename  |
| docsDevSwAdminStatus<br>OID: 1.3.6.1.2.1.69.1.3.3.0  | 2 (Upgrade on next reboot)   |
| Manufacturer CVC TLV:32                              | The CVC file for the DM3.0 Series Transponder (embed in the Configuration File). |

**Table 5-3, DOCSIS Configurations File Values**

The firmware will be upgraded on the next reset. Monitor the upgrade status with the docsDevSwOperStatus MIB parameter, and verify the firmware version with the docsDevSwCurrentVers MIB parameter (refer to Table 5-1, Modem Firmware Upgrade SNMP Parameters). Once the firmware has been upgraded, the modem will automatically run the new version.



# 6.0 Data Management

## 6.1 SCTE-HMS MIBs

The DM3.0 Series Transponder remotely reports power supply data and alarms using the Simple Network Management Protocol (SNMP) over the DOCSIS (Data Over Cable Service Interface Specification) communications standard. The DM3.0 Series Transponder typically reports into a centralized Network Management System (NMS) through a standard collection of data access points referred to as the SCTE-HMS Management Information Bases (MIBs). The NMS polls the DM3.0 Series Transponder for power supply data with the option of having the transponder send SNMP traps in the event that an alarm condition occurs.

The following MIB (Management Information Base) files are required for the NMS or SNMP Manager to collect data from the transponders. These files can be found on the Society of Cable Telecommunications Engineers (SCTE) Web site [www.scte.org](http://www.scte.org). There are dependencies between MIB files so they should be compiled in the order listed below:

| SCTE-HMS MIB Files                           |  |
|--|--|
| Reference Number                             | Description  |
| ANSI/SCTE 36 2002R2007<br>(formerly HMS 028) | SCTE-ROOT Management Information Base (MIB) Definitions  |
| ANSI/SCTE 37 2010<br>(formerly HMS 072),     | Hybrid Fiber/Coax Outside Plant Status Monitoring<br>SCTE-HMS-ROOTS Management Information Base (MIB) Definition                               |
| ANSI/SCTE 38-1 2009<br>(formerly HMS 026)    | Hybrid Fiber/Coax Outside Plant Status Monitoring<br>SCTE-HMS-PROPERTY-MIB Management Information Base (MIB) Definition                        |
| ANSI/SCTE 38-2 2005<br>(formerly HMS 023)    | Hybrid Fiber/Coax Outside Plant Status Monitoring<br>SCTE-HMS-ALARMS-MIB Management Information Base (MIB) Definition                          |
| ANSI/SCTE 38-3 2008<br>(formerly HMS 024)    | Hybrid Fiber/Coax Outside Plant Status Monitoring<br>SCTE-HMS-COMMON-MIB Management Information Base (MIB) Definition                          |
| ANSI/SCTE 38-4 2006<br>(formerly HMS 027)    | Hybrid Fiber/Coax Outside Plant Status Monitoring<br>SCTE-HMS-PS-MIB Management Information Base (MIB) Definition                              |
| ANSI/SCTE 38-6 2006<br>(formerly HMS 033)    | Hybrid Fiber/Coax Outside Plant Status Monitoring<br>SCTE-HMS-GEN-MIB Management Information Base (MIB) Definition                             |
| ANSI/SCTE 38-7 2008<br>(formerly HMS 050)    | Hybrid Fiber/Coax Outside Plant Status Monitoring<br>SCTE-HMS-Transponder-Interface-Bus (TIB)-MIB Management Information Base (MIB) Definition |

**Table 6-1, SCTE-HMS MIB Files**

### 6.2 SCTE-HMS MIB Alarms

#### 6.2.1 SCTE-HMS Configurable Alarms

The HMS discrete and analog alarms provide the capability to monitor and alarm various power supply and environmental conditions and measurements. The alarms in the SCTE-HMS propertyTable and the discretePropertyTable can be defined and set to provide a custom monitoring system.

The following section provides an example and detailed information on how to set values and enable or disable alarms in the MIB tables. For ease of reference they are in this sequence:

- An example of how to set a temperature alarm.
- A table to help convert the desired reported alarm states to hexadecimal for setting the MIB.
- Commonly monitored parameters and recommended values.

Example:

The alarms for psTemperature on the following page are set so that the normal temperature range is from 30°C to 45°C. If the temperature rises above 45°C, a casHI alarm will be sent to the alarmTable. Anything over 50°C is considered a critical condition and will generate a casHIHI alarm. If the temperature falls below the normal level of 30°C, casLO will be generated and if it continues to drop below 0, a casLOLO will be generated. The temperature must rise above the LOLO limit plus the deadband value of 3°C before the casLOLO alarm will change to a casLO. The alarmEnable field is set to 0F Hex to monitor and alarm for all conditions.

## 6.0 Data Management, continued

| Instance                            | parameterOID(DX)          | alarmEnable | currentAlarmState | analogAlarmHiHi | analogAlarmHi | analogAlarmLo | analogAlarmLoLo | analogAlarmDeadband |
|-------------------------------------|---------------------------|-------------|-------------------|-----------------|---------------|---------------|-----------------|---------------------|
| 13.1.3.6.1.4.1.5591.1.4.2.1.22.1    | psOutputVoltage.1         | 00 (hex)    | casNominal(1)     | 0               | 0             | 0             | 0               | 0                   |
| 13.1.3.6.1.4.1.5591.1.4.2.1.23.1    | psInputVoltage.1          | 00 (hex)    | casNominal(1)     | 0               | 0             | 0             | 0               | 0                   |
| 13.1.3.6.1.4.1.5591.1.4.2.1.28.1    | psTotalStringVoltage.1    | 00 (hex)    | casNominal(1)     | 0               | 0             | 0             | 0               | 0                   |
| 13.1.3.6.1.4.1.5591.1.4.2.1.30.1    | psPowerOut.1              | 00 (hex)    | casNominal(1)     | 0               | 0             | 0             | 0               | 0                   |
| 13.1.3.6.1.4.1.5591.1.4.2.1.31.1    | psFrequencyOut.1          | 00 (hex)    | casNominal(1)     | 0               | 0             | 0             | 0               | 0                   |
| 14.1.3.6.1.2.1.10.127.1.1.1.1.6.3   | docsIDownChannelPower.3   | 00 (hex)    | casNominal(1)     | 150             | 100           | -100          | -150            | 15                  |
| 14.1.3.6.1.2.1.10.127.1.2.2.1.3.2   | docsICmStatusTxPower.2    | 00 (hex)    | casNominal(1)     | 550             | 500           | 0             | 0               | 15                  |
| 14.1.3.6.1.4.1.5591.1.4.3.1.3.1.1   | psStringChargeCurrent.1.1 | 00 (hex)    | casNominal(1)     | 0               | 0             | 0             | 0               | 0                   |
| 14.1.3.6.1.4.1.5591.1.4.3.1.3.1.2   | psStringChargeCurrent.1.2 | 00 (hex)    | casNominal(1)     | 0               | 0             | 0             | 0               | 0                   |
| 14.1.3.6.1.4.1.5591.1.4.3.1.5.1.1   | psStringFloat.1.1         | 00 (hex)    | casNominal(1)     | 0               | 0             | 0             | 0               | 0                   |
| 14.1.3.6.1.4.1.5591.1.4.3.1.5.1.2   | psStringFloat.1.2         | 00 (hex)    | casNominal(1)     | 0               | 0             | 0             | 0               | 0                   |
| 14.1.3.6.1.4.1.5591.1.4.5.1.3.1.1   | psOutputCurrent.1.1       | 00 (hex)    | casNominal(1)     | 0               | 0             | 0             | 0               | 0                   |
| 14.1.3.6.1.4.1.5591.1.4.6.1.3.1.1   | psTemperature.1.1         | 0F (hex)    | casNominal(1)     | 50              | 45            | 30            | 0               | 3                   |
| 15.1.3.6.1.4.1.5591.1.4.4.1.4.1.1.1 | psBatteryVoltage.1.1.1    | 0F (hex)    | casNominal(1)     | 1600            | 1500          | 1100          | 1050            | 100                 |
| 15.1.3.6.1.4.1.5591.1.4.4.1.4.1.1.2 | psBatteryVoltage.1.1.2    | 0F (hex)    | casNominal(1)     | 1600            | 1500          | 1100          | 1050            | 100                 |
| 15.1.3.6.1.4.1.5591.1.4.4.1.4.1.1.3 | psBatteryVoltage.1.1.3    | 0F (hex)    | casNominal(1)     | 1600            | 1500          | 1100          | 1050            | 100                 |
| 15.1.3.6.1.4.1.5591.1.4.4.1.4.1.2.1 | psBatteryVoltage.1.2.1    | 0F (hex)    | casNominal(1)     | 1600            | 1500          | 1100          | 1050            | 100                 |
| 15.1.3.6.1.4.1.5591.1.4.4.1.4.1.2.2 | psBatteryVoltage.1.2.2    | 0F (hex)    | casNominal(1)     | 1600            | 1500          | 1100          | 1050            | 100                 |
| 15.1.3.6.1.4.1.5591.1.4.4.1.4.1.2.3 | psBatteryVoltage.1.2.3    | 0F (hex)    | casNominal(1)     | 1600            | 1500          | 1100          | 1050            | 100                 |

| Binary to Hex Conversions for Alarm Settings |       |       |       |       |       |       |       |     |                    |
|--|-------|-------|-------|-------|-------|-------|-------|-----|--------------------|
| Unused                                       |       |       |       | HiHi  | Hi    | Lo    | LoLo  | Hex | Enabled Alarms     |
| Bit 7  | Bit 6 | Bit 5 | Bit 4 | Bit 3 | Bit 2 | Bit 1 | Bit 0 |     |                    |
| 0  | 0     | 0     | 0     | 0     | 0     | 0     | 0     | 00  | No Alarms          |
| 0  | 0     | 0     | 0     | 0     | 0     | 0     | 1     | 01  | LoLo               |
| 0  | 0     | 0     | 0     | 0     | 0     | 1     | 0     | 02  | Lo                 |
| 0  | 0     | 0     | 0     | 0     | 0     | 1     | 1     | 03  | Lo, LoLo           |
| 0  | 0     | 0     | 0     | 0     | 1     | 0     | 0     | 04  | Hi                 |
| 0  | 0     | 0     | 0     | 0     | 1     | 0     | 1     | 05  | Hi, LoLo           |
| 0  | 0     | 0     | 0     | 0     | 1     | 1     | 0     | 06  | Hi, Lo             |
| 0  | 0     | 0     | 0     | 0     | 1     | 1     | 1     | 07  | Hi, Lo, LoLo       |
| 0  | 0     | 0     | 0     | 1     | 0     | 0     | 0     | 08  | HiHi               |
| 0  | 0     | 0     | 0     | 1     | 0     | 0     | 1     | 09  | HiHi, LoLo         |
| 0  | 0     | 0     | 0     | 1     | 0     | 1     | 0     | 0A  | HiHi, Lo           |
| 0  | 0     | 0     | 0     | 1     | 0     | 1     | 1     | 0B  | HiHi, Lo, LoLo     |
| 0  | 0     | 0     | 0     | 1     | 1     | 0     | 0     | 0C  | HiHi, Hi           |
| 0  | 0     | 0     | 0     | 1     | 1     | 0     | 1     | 0D  | HiHi, Hi, LoLo     |
| 0  | 0     | 0     | 0     | 1     | 1     | 1     | 0     | 0E  | HiHi, Hi, Lo       |
| 0  | 0     | 0     | 0     | 1     | 1     | 1     | 1     | 0F  | HiHi, Hi, Lo, LoLo |

Table 6-2, Binary to Hex Conversions for Alarm Settings

## 6.0 Data Management, continued

The following table displays the various analog alarms with common settings for the DM3.0 Series Transponder.

| Analog Alarms and Common Settings |      |  |              |   |         |  |      |          |
|-----------------------------------|------|--|--------------|---|---------|--|------|----------|
| Analog Alarms                     |      | Description  | Alarm Enable | LOLO  | LO      | HI   | HIHI | Deadband |
| psTotalStringVoltage              | 36V  | Scaled representation of the full battery string in 1/100 Volts units                            | 0x0F         | 3300  | 3500    | 4520   | 4570 | 50       |
| Individual Battery Voltage        |      | Battery Voltage of 12V Battery in 1/100 Volts units  | 0x0F         | 1050  | 1150    | 1530   | 1550 | 20       |
| psInputVoltage                    | 120V | Scaled representation of the input line voltage in 1/100 Volts units                             | 0x0F         | Varies by site. The XM3 will switch to standby at nominal +15% / -30% |         |  |      |          |
|                                   | 220V |  | 0x0F         |   |         |  |      |          |
| psRMSCurrentIn                    |      | Scaled representation of the Power Supply's RMS current in 1/100 A units                         | 0x00         | Set as desired per site   |         |  |      |          |
| psPowerIn                         |      | Representation of the Power Supply's input power in 1 W units                                    | 0x00         | Set as desired per site   |         |  |      |          |
| psFrequencyOut                    |      | Representation of Power Supply's output frequency in 1/100 Hz units                              | 0x00         | Set as desired per site   |         |  |      |          |
| psOutputVoltage                   |      | Scaled representation of the Power Supply output voltage in 1/100 Volts units                    | 0x0F         | 4300  | 4550    | 5050   | 5300 | 200      |
|                                   |      |  | 0x0F         | 5650  | 6000    | 6600   | 7000 | 200      |
|                                   |      |  | 0x0F         | 7800  | 8200    | 9150   | 9300 | 200      |
| psPowerOut                        |      | Representation of Power Supply output power in 1W units  | 0x00         | It is recommended that psOutputCurrent be used for output alarms.     |         |  |      |          |
| psStringChargeCurrent             |      | Battery string charge current, scaled in 1/100 Amp units   | 0x0C         | Disable   | Disable | 1200   | 1250 | 20       |
| psStringDischargeCurrent          |      | Scaled representation of battery string discharge current. This is an RMS value in 1/100 Amps    | 0x00         | Set as desired per site   |         |  |      |          |
| psStringFloat                     |      | Battery string float charge current, scaled in 1/100 Amp units                                   | 0x0C         | Disable   | Disable | 1200   | 1250 | 20       |
| psOutputCurrent                   | 15A  | Scaled representation of Power Supply RMS current in 1/100 Amp units                             | 0x0C         | Disable   | Disable | 1650   | 1720 | 20       |
|                                   | 18A  |  | 0x0C         | Disable   | Disable | 1980   | 2060 | 20       |
| psTemperature                     |      | -40 to +80 degrees C   | 0x0F         | Varies by Site  |         |  |      |          |
| docsIfDownChannelPower            |      | The CM's receive RF power scaled in 1/10 dBmV units  | 0x0F         | -150  | -10     | 10   | 150  | 15       |
| docsIfCmStatusTxPower             |      | The CM's transmit RF power scaled in 1/10 dBmV units   | 0x0C         | 0   | 0       | 500  | 550  | 15       |
| atiBBsysViewTimeInStandby         |      | Time in seconds that the Power Supply's inverter is currently running due to outage or self test | 0x0C         | 0   | 0       | Set as desired for notification of extended outage |      | 10       |
| Alarms for Optional Generator     |      |  |              |   |         |  |      |          |
| GenVBatIgnition                   |      | Scaled representation of the generator's ignition battery in 1/100 Volts                         | 0x0F         | 1150  | 1200    | 1500   | 1550 | 20       |
| genEnclosureTemperature           |      | Temperature inside generator's enclosure in degrees C  | 0x09         | -40   | 0       | 0  | 55   | 5        |

**Table 6-3, Recommended Settings for DM3.0 Series Transponder Analog Alarms**

## 6.0 Data Management, continued

| Recommended Settings for Discrete Alarms |   |               |
|--|---|---------------|
| Discrete Alarms                          | Description                                     | Setting       |
| psInverterStatus (1)                     | Inverter Off                                    | Disable       |
| psInverterStatus (2)                     | Inverter Running Due to Loss of AC Line Voltage | discreteMinor |
| psInverterStatus (3)                     | Self Test Initiated Locally                     | Disable       |
| psInverterStatus (4)                     | Self Test Initiated Remotely                    | Disable       |
| psInverterStatus (5)                     | Last Self Test Failed                           | Disable       |
| psMajorAlarm (1)                         | No Alarm  | Disable       |
| psMajorAlarm (2)                         | Alarm   | discreteMajor |
| psMinorAlarm (1)                         | No Alarm  | Disable       |
| psMinorAlarm (2)                         | Alarm   | discreteMinor |
| psTamper (1)                             | Closed  | Disable       |
| psTamper (2)                             | Open  | discreteMajor |
| psInputVoltagePresence (1)               | AC Line Voltage Lost                            | Disable       |
| psInputVoltagePresence (2)               | AC Line Voltage Present                         | Disable       |
| Battery Standby Time Remaining (1)       | Over 3 Hours Remaining                          | Disable       |
| Battery Standby Time Remaining (2)       | 2 to 3 Hours Remaining                          | Disable       |
| Battery Standby Time Remaining (3)       | 1 to 2 Hours Remaining                          | discreteMinor |
| Battery Standby Time Remaining (4)       | Less than 1 Hour Remaining                      | discreteMajor |
| Battery Standby Time Remaining (5)       | Calculating                                     | Disable       |
| Battery Standby Time Remaining (6)       | Not Available                                   | Disable       |
| tibControlMode (2)                       | Device is Under Local Control                   | Disable       |
| tibControlMode (3)                       | Remote Device is Not Responding                 | discreteMajor |

**Table 6-4, Recommended Settings for Discrete Alarms**

## 6.0 Data Management, continued

| Discrete Alarms for Optional Generator |   |               |
|--|---|---------------|
| Discrete Alarms                        | Description   | Setting       |
| genGeneratorStatus (1)                 | Generator OFF   | Disable       |
| genGeneratorStatus (2)                 | Generator Running (Test)  | discreteMinor |
| genGeneratorStatus (3)                 | Generator Running   | discreteMajor |
| genGeneratorStatus (4)                 | Generator Fail  | discreteMajor |
| genGasHazard (1)                       | No Alarm  | Disable       |
| genGasHazard (2)                       | The concentration of hydrocarbon fuel in the generator enclosure has exceeded safe limits. Generator operation is suspended. The alarm is cleared when the sensor reports safe conditions, and the alarm is reset via the resetLatchedAlarms(3) command found in the genEquipmentControl MIB point. | discreteMajor |
| genWaterIntrusion (1)                  | No Alarm  | Disable       |
| genWaterIntrusion (2)                  | Water level within the generator or fuel enclosure has exceeded safe limits for generator operation. Generator operation is suspended while this alarm is active. The alarm resets when the water returns to a safe level.  | discreteMajor |
| genPadShear (1)                        | No Alarm  | Disable       |
| genPadShear (2)                        | Indicates that the generator or fuel enclosure has shifted from its mounting position. Generator operation is suspended. The alarm resets when the unit is returned to its original position.   | discreteMajor |
| genEnclosureDoor (1)                   | No Alarm  | Disable       |
| genEnclosureDoor (2)                   | Generator and/or auxiliary fuel enclosure door is open  | discreteMajor |
| genCharger (1)                         | No Alarm  | Disable       |
| genCharger (2)                         | Ignition battery charger is not operating correctly   | discreteMajor |
| genFuel (1)                            | No Alarm  | Disable       |
| genFuel (2)                            | Indicates the engine's fuel supply is insufficient for extended operation. Alarm resets when fuel is replenished.   | discreteMajor |
| genOil (1)                             | No Alarm  | Disable       |
| genOil (2)                             | Indicates the engine's oil is inadequate for safe operation. Alarm resets when the condition returns to normal.   | discreteMajor |
| genMinorAlarm (1)                      | No Alarm  | Disable       |

**Table 6-4, Recommended Settings for Discrete Alarms, continued**

## 6.0 Data Management, continued

| Discrete Alarms for Optional Generator, continued |   |               |
|---|---|---------------|
| Discrete Alarms                                   | Description   | Setting       |
| genMinorAlarm (2)                                 | The generator is indicating a minor alarm. The generator requires attention, but does not require an immediate visit to the site. | discreteMinor |
| genMajorAlarm (1)                                 | No Alarm  | Disable       |
| genMajorAlarm (2)                                 | The generator is indicating a major alarm. The generator requires immediate attention.  | discreteMajor |
| atiMgmtSysloPinCtrl (1)                           | Contact Open  | Disable       |
| atiMgmtSysloPinCtrl (2)                           | Contact Closed  | Disable       |
| atiMgmtSysloPinIn4 (1)                            | Contact Open  | Disable       |
| atiMgmtSysloPinIn4 (2)                            | Contact Closed  | Disable       |
| atiMgmtSysloPinIn5 (1)                            | Contact Open  | Disable       |
| atiMgmtSysloPinIn5 (2)                            | Contact Closed  | Disable       |
| atiMgmtSysloPinIn6 (1)                            | Contact Open  | Disable       |
| atiMgmtSysloPinIn6 (2)                            | Contact Closed  | Disable       |

**Table 6-4, Recommended Settings for Discrete Alarms, continued**

### DM3.0 Alarm Cloning & Distribution

SCTE-HMS Alarm settings can be distributed automatically to all DM3.0 Series Transponders on the network. Use the following procedure to configure and distribute the alarm settings.

1. Select the desired SCTE-HMS alarm settings on a master DM3.0 Series Transponder.

The SCTE-HMS-PROPERTY MIB defines a method for setting thresholds for analog and discrete values that can be used for setting traps or alerting a Network Management System when those thresholds are compromised. There are two SCTE-HMS SNMP MIB Tables where these values are configured:

propertyTable OID: 1.3.6.1.4.1.5591.1.1.1

This table is used for setting thresholds for analog properties such as input & output voltages, individual battery voltages, currents and temperature.

discretePropertyTable OID: 1.3.6.1.4.1.5591.1.1.3

This table is used to set alarm parameters on discrete conditions such as tamper on/off, major/minor alarms and various inverter status conditions.

Full explanations of these MIB tables and their settings can be found by reading the SCTE-HMS-PROPERTY MIB. The MIB table alarm settings can be changed to desired values using a SNMP MIB browser or status monitoring software. Once the tables are configured with the desired alarm settings, proceed to Step 2 on exporting the "AlarmSettings.acf" file.

## 6.0 Data Management, continued

2. Export the “AlarmSetting.acf” file of the master transponder’s alarm settings.
3. Connect to the Web page of the master transponder.
4. Navigate to the Advanced Configuration menu and select the HMS Alarms page.
5. Verify the alarm settings defined in Step 1 are displayed in the propertyTable and discrete PropertyTable. If further changes to the alarm settings are required, refer to Step 1.
6. Click on the Export button at the bottom of the HMS Alarms page.
7. When prompted, refer to Section 4.3.1, Web Interface Security Levels for the applicable User Name and Security Password.
8. Download the “AlarmSettings.acf” file to the TFTP root directory. If desired, the file may be renamed.
9. Distribute the “AlarmSettings.acf” file to other transponders.
10. The “AlarmSettings.acf” file is distributed to other transponders by setting the following Alpha MIB parameters to the indicated values. This can be done to an individual transponder using a MIB browser, or to multiple transponders by placing the SNMP OIDs into the modem’s DOCSIS configuration file or the proprietary atidoc33.cfg configuration file.

| DM3 Alarm Setting Parameters   |                   |   |
|--|-------------------|---|
| Parameter  | Type              | Value   |
| atiMgmtSysDownload<br>OID: 1.3.6.1.4.1.926.1.3.2.1                           | Object Identifier |   |
| atiMgmtSysDownloadTftpAddress<br>OID: 1.3.6.1.4.1.926.1.3.2.1.1.0            | IP Address        | The IP address of the TFTP server on which AlarmSettings.acf is stored. |
| atiMgmtSysDownloadFile1<br>OID: 1.3.6.1.4.1.926.1.3.2.1.4.0                  | Octet String      | Set to “AlarmSettings.acf” or other specified file name.                |
| atiMgmtSysDownloadCtrl<br>OID: 1.3.6.1.4.1.926.1.3.2.1.2.0                   | Integer           | 1 = Initiate download of “AlarmSettings.acf” file.                      |
| atiMgmtSysDownloadTftpServerAddressType<br>OID: 1.3.6.1.4.1.926.1.3.2.1.15.0 | Integer           | Address mode of atiMgmtSysDownloadTftpServerAddress. IPv4(1),IPv6(2)    |
| atiMgmtSysDownloadTftpServerAddress<br>1.3.6.1.4.1.926.1.3.2.1.16.0          | Octet String      | Address of download TFTP server. 0.0.0.0 (IPv4), 0:0:0:0:0:0:0:0 (IPv6) |

**Table 6-5, DM3.0 Series Transponder Alarm Setting Parameters**

The status of the alarm settings download can be monitored with the following parameters (please note the AlarmSettings.acf file downloads quickly):

| Status of Alarm Setting Download Parameters                    |                   |  |
|--|-------------------|--|
| Parameter  | Type              | Value  |
| atiMgmtSysDownloadProgress<br>OID: 1.3.6.1.4.1.926.1.3.2.1.6.0 | Integer           | Byte count of the file download process.                 |
| atiMgmtSysDownloadStatus<br>OID: 1.3.6.1.4.1.926.1.3.2.1.3.0   | Read Only Integer | 1 = Idle<br>5 = Transferring<br>6 = Testing<br>8 = Error |

**Table 6-6, Status of Alarm Setting Download Parameters**

Verify the transponder’s SCTE-HMS property tables have been updated by viewing the HMS Alarms Web page, status monitoring system or SNMP MIB browser.



## 6.0 Data Management, continued

### 6.2.2 SNMP Traps

Use of SNMP Traps allow the network manager to set conditions (alarms) under which the device (or devices) autonomously reports to the headend the existence of the pre-configured event. The type of event determines the level of action to be taken.

1. Verify the IP address of the trap destination server(s) has been configured.
  - If the trap destination server requires configuration, refer to Section 3.3.3 Setting SNMP Trap Destination IPv4 Method, and 3.3.4 Setting SNMP Trap Destination Addresses—IPv6 Method, for instructions.
2. Alarms must be configured. SNMP alarm traps sent by the transponder are formatted according to the SCTE-HMS-ALARM-MIB specification with the following information included:
  - SNMP Trap community string:
  - commonTrapCommunityString, OID 1.3.6.1.4.1.5591.1.3.1.11.0
  - Default value is “public”

Example Alarm Trap:

The example below is a psTamper alarm trap indicating a discreteMinor alarm: Tamper is open. Data from the raw trap will appear as shown below. Refer to Table 6-7, SNMP Alarm Trap Varbinds and Explanations, for definitions of the varbinds.

```
Frame 441 (230 bytes ib wire, 230 bytes captured)
Ethernet II, Src: 192.168.1.77 (00:90:EA:A0:01:4E), Dst: 3com_0d:1d:d4 (00:10:5a:0dL1d:d4)
Internet Protocol, Src Port: 62481 (62481), Dst Port: snmptrap (162)
Simple Network Management Protocol

Version: 1 (0)
Community: PUBLIC
PDU type: TRAP-V1 (4)
Enterprise: 1.3.6.1.4.1.5591.1 (SNMPv2-SMI::enterprises.5591.1)
Agent address: 0.0.0.0 (0.0.0.0)
Trap type: ENTERPRISE SPECIFIC (6)
Specific trap type: 1
Timestamp: 2358751
Object identifier 1: 1.3.6.1.4.1.5591.1.3.2.7.0 (SNMPv2-SMI::enterprises.5591.1.3.2.7.0)
Value: Hex-STRING: 00 90 EA A0 0B 82

Object identifier 2: 1.3.6.1.4.1.5591.1.3.1.1.0 (SNMPv2-SMI::enterprises.5591.1.3.2.1.0)
Value STRING: "123 Example Ave."
Object identifier 3: 1.3.6.1.4.1.5591.1.2.3.1.2.1 (SNMPv2-SMI::enterprises.5591.1.2.3.1.2.1)
Value: Hex-STRING: 00 00 00 76 07 10 06 0D 2B 06 01 04 01 AB 57 01 04 02 01 1B 01 02 01 02

Object identifier 4: 1.3.6.1.4.1.5591.1.4.2.1.27.1 (SNMPv2-SMI::enterprises.5591.1.3.2.1.0)
Value: INTEGER: 2
Object identifier 5: 1.3.6.1.4.1.5591.1.1.2.1.2 (SNMPv2-SMI::enterprises.5591.1..1.2.1.2)
Value: INTEGER: 7
```

## 6.0 Data Management, continued

When viewed through a third-party trap receiver, the translated varbinds and data values will be displayed in a format similar to the sample below:

Bindings (5)

Binding #1: commonPhysAddress.0 \*\*\* (octets) 00:90.EA.A0.01.4E (hex)

Binding #2: commonLogicalID.0 \*\*\* (octets) (123 Example Ave.)

Binding #3: alarmLogInformation.1 \*\*\* (octets) 00.00.00.76.07.10.06.0D.2B.06.01.04.01.AB.57.01.04.02.01.1B.01.02.01.02 (hex)

Binding #4: psTamper.1 \*\*\* (int32) open (2)

Binding #5: currentAlarmAlarmState \*\*\* (int32) caasDiscreteMinor(7)

| SNMP Alarm Trap Varbinds and Explanations                                       |  |
|---|--|
| Varbind   | Explanation  |
| Binding #1<br>commonPhysAddress<br>OID: 1.3.6.1.4.1.5591.1.3.2.7.0              | MAC address of the Communications Module   |
| Binding #2<br>commonLogicalID<br>OID: 1.3.6.1.4.1.5591.1.3.1.1.0                | Optional user-configurable parameter that is often used to provide a unique logical name, or even the physical address of where the Communications Module is installed.  |
| Binding #3<br>alarmLogInformation<br>OID: 1.3.6.1.4.1.5591.1.2.3.1.2.1          | This varbind was designed by the SCTE-HMS committee with the intention of being used by sophisticated trap interpreters. The information is "coded" within the octet strings:<br>Octet 1-4: POSIX Time of alarm occurrence (most significant byte first)<br>Octet 5: Alarm Type (See description below)<br>Octet 6: Contents of commonNeStatus immediately after alarm occurred<br>Octet 7-m: Alarm Object Identifier (BER encoded)<br>Octet n-z: Alarm value (BER encoded)<br>Most trap interpreters cannot decode this message, which is why varbinds 4 and 5 were added that provide the same information in a more useable format. |
| Binding #4<br>Alarmed Parameter OID/Value<br>OID: 1.3.6.1.4.1.5591.1.4.2.1.27.1 | This field provides the varbind of the parameter that is alarming along with the value of that parameter. This is the same information encoded in varbind #3 Octets 7 through Z.<br>In the example above the value would be:<br>OID: 1.3.6.1.4.1.5591.1.4.2.1.27.1.0 (psTamper)<br>Value: 2 (Open)   |
| Binding #5<br>Alarm Location/Type<br>OID: 1.3.6.1.4.1.5591.1.1.2.1.2            | This is the information from varbind #3 Octet 5 above. The alarm location will always be the SCTE-HMS currentAlarmAlarmState and the type will be determined based on how the alarm was configured in the SCTE-HMS PropertyIdent MIB tables.<br>OID 1.3.6.1.4.1.5591.1.1.2.1.2.0 (currentAlarmAlarmState)<br>Type: 1-7 based on SCTE definitions:<br>1 NOMINAL<br>2 HIHI<br>3 HI<br>4 LO<br>5 LOLO<br>6 Discrete Major<br>7 Discrete Minor<br>The Type will be determined by how the alarm is configured in the SCTE-HMS PropertyIdent MIB, whether it is a Discrete or Analog alarm and the level of alarm defined for that state.    |

Table 6-7, SNMP Alarm Trap Varbinds and Explanations

## 6.0 Data Management, continued

### Trap on Normal

The DM3.0 Series Transponder has the capability of sending a “return to normal” trap once an alarmed condition returns to a normal state. This feature is enabled by default, but can be disabled by setting the TRAP ON NORMAL parameter in the the MIB point `atiMgmtSnmpTrapOnNormal` to a value of “2”. The contents of this trap message will be identical to the SNMP Alarm traps, but the value of the Alarm Type defined in the 5th varbind will be “1” (NOMINAL).

### SCTE-HMS Warm-Start Trap

In addition to the SNMP alarm traps, the DM3.0 Series Transponder will also send an SCTE-HMS warm-start trap when it is initialized. Some SNMP monitoring software requires this trap for auto-identification of the transponder. The format of this trap will be similar to the alarm trap, but the only information sent will be:

- `commonTrapCommunityString`, OID 1.3.6.1.4.1.5591.1.3.1.11.0
- `commonPhyAddress`, OID, 1.3.6.1.4.1.5591.1.3.2.7
- `commonLogicalID`, OID 1.3.6.1.4.1.5591.1.3.1.1.0

### SCTE-HMS Cold-Start Trap

An SNMP-HMS cold-start trap will be generated by the DM3.0 Series Transponder anytime it initializes with a new firmware version. In addition, a cold-start trap is sent whenever the configuration has changed. If any parameter in the HMS PROPERTY table has changed since the last reset, a cold-start trap will be sent upon the next reset.

## 6.2.3 General Power Supply Alarms

The Intelligent CableUPS detects a wide array of alarms and displays the type of active alarm in the Smart Display screen and the severity of alarm (e.g., Major/Minor) by means of the Inverter Module LEDs.

General power supply alarms are passed directly from the power supply to the transponder without specific definition and are classified in the HMS MIB table as `psMinorAlarm` and `psMajorAlarm`. There are a number of problems that can generate these alarms and the exact nature of the situation is not specified. Minor and Major alarms are defined by the SCTE standards committee as follows:

#### `psMajor`

“Service has been dropped or a service interruption is imminent.” Indicates that an immediate truck roll is appropriate. Several `psMajor` alarms are latching, meaning that the alarm won’t clear until the problem is fixed and after a successful completion of a Self Test. A Self Test is the preferred method of verifying the resolution of the alarm condition as cycling the power has the potential of masking the problem and not indicating the actual state of the system.

#### `psMinor`

“A non-service affecting condition has occurred and should be monitored.”

## 6.0 Data Management, continued

The following table lists the psMajor and psMinor alarm definitions for the XM3 power supply.

| Power Alarms: Classifications, Causes and Corrections |            |   |  |                  |
|---|------------|---|--|------------------|
| Active Alarm  | Alarm Type | Probable Cause of Alarm   | Corrective Action  | Standby Disabled |
| Self Test FAIL  | Major      | Output voltage failed, batteries less than 1.85V/C, or main AC interruption during Self Test.                             | 1. Check Batteries<br>2. Check Inverter                              | NO               |
| LINE ISOLATION  | Major      | Line isolation has failed and Inverter operations are suspended.  | 1. Replace Power Supply as soon as possible                          | YES              |
| OUTPUT FAILURE  | Major      | The AC output has failed due to a bad Inverter or transformer.  | 1. Apply load >1.5A<br>2. Output Overloaded<br>3. Check Inverter     | NO               |
| OUTPUT OVERLOAD                                       | Major      | The output is overloaded or shorted.  | 1. Output Short Circuit<br>2. Check Output Current                   | NO               |
| OUTPUT 1 TRIPPED                                      | Major      | Output 1 PIM hardware protection mode is engaged and overloaded.  | 1. Over Current<br>2. Check Settings                                 | NO               |
| OUTPUT 2 TRIPPED                                      | Major      | Output 2 PIM hardware protection mode is engaged and overloaded.  | 1. Over Current<br>2. Check Settings                                 | NO               |
| CHARGER FAILURE                                       | Major      | Charger has failed to shut down; possible battery over temperature condition exists.                                      | 1. Re-seat Inverter<br>2. Perform Self Test                          | NO               |
| INVERTER TEMP   | Major      | Inverter heat sink has exceeded set temperature. (Stand-by operations suspended until temperature drops to a safe level.) | 1. Check Inverter<br>2. Check PDB<br>3. Check Enclosure Ventilation  | NO               |
| CONFIG ERROR  | Major      | The Power Supply is improperly configured and operation is suspended until error is corrected.                            | 1. Wrong Input Voltage or Frequency                                  | NO               |
| INVERTER ALARM / INVERTER FAILED                      | Major      | No output detected with good batteries for 30 seconds OR inverter is disconnected from PDB.                               | 1. Re-seat Inverter<br>2. Replace Inverter                           | YES              |
| INPUT FAILURE   | Minor      | Utility AC input has failed.  | 1. Utility Failure<br>2. Check Input Breaker<br>3. Input Connections | NO               |
| INPUT OVER CURR / INPUT CURRENT LIMIT                 | Minor      | AC Input current exceeds threshold setting.   | 1. Reduce Output Load<br>2. Check Input Current Limit Setting        | NO               |
| SURGE MOV FAIL  | Minor      | The MOV board surge protection has failed and needs to be replaced.   | 1. Replace MOV Board   | NO               |
| ALPHADOC OPTION                                       | Minor      | I2C has failed between XM3 and DOC.   | 1. Check Ribbon Cable<br>2. Replace DOC                              | NO               |
| INVERTER ENABLE                                       | Minor      | System controller has disabled the Inverter.  | 1. Check Inverter  | YES              |
| CHARGER ENABLE  | Minor      | System controller has disabled the charger.   | 1. Check Charger   | NO               |
| APP OPTION  | Minor      | I2C has failed between XM3 and APP.   | 1. Check Ribbon Cable<br>2. Replace APP                              | NO               |
| INV EEPROM ERROR                                      | Minor      | There has been an error reading the EEPROM on the inverter board.   | 1. Replace Inverter  | NO               |
| HW COMPATIBILITY                                      | Minor      | There is a hardware incompatibility between the main micro board and the inverter board.                                  | 1. Check Micro Board<br>2. Check Inverter Brd                        | NO               |
| PDB EEPROM ERROR                                      | Minor      | There has been an error reading the EEPROM on the PDB.  | 1. Replace Power Supply  | NO               |

**Table 6-8, Power Alarms: Classifications, Causes and Corrections**

## 6.0 Data Management, continued

### 6.2.4 Battery Alarms

The Intelligent CableUPS detects a wide array of battery alarms and displays the type of active alarm in the Smart Display screen and the severity of alarm (e.g., Major/Minor) by means of the Inverter Module LEDs.

| Battery Alarms: Classifications, Causes and Corrections |            |  |   |                  |
|---|------------|--|---|------------------|
| Active Alarm  | Alarm Type | Probable Cause of Alarm  | Corrective Action   | Standby Disabled |
| NO BATTERIES  | Major      | Detected the absence of batteries (alarm inactive when battery capacity or number of battery strings is set to 0)  | 1. Check Batt Breaker<br>2. Check Connections<br>3. Check Battery Fuse          | YES              |
| LOW BATT VOLTS  | Major      | Battery voltages below 1.833V/cell   | 1. Check AC Input<br>2. Restore AC Input<br>3. Connect Generator                | NO               |
| HIGH BATT VOLTS   | Major      | Battery voltages above 4.5V over target charger voltage  | 1. Check Batteries<br>2. Replace Inverter                                       | NO               |
| BATTERY EOD   | Major      | Output batteries dropped below the low voltage shutdown level (low battery disconnect)   | 1. Restore AC Input<br>2. Connect Generator                                     | YES              |
| BATTERY FAIL  | Major      | Charge current > 5.0A for 7 days while in float mode   | 1. Check Batteries<br>2. Replace Batteries                                      | NO               |
| BATT TEMP PROBE   | Minor      | Precision Temperature Sensor (PTS) failed or is not installed.   | 1. Check Connection<br>2. Replace Sensor  | NO               |
| REFRESH / BATT REFRESH ALARM                            | Minor      | Battery Temperature Exceeded 60°C  | 1. Check Charger Settings<br>2. Check Batteries<br>3. Check Battery Temperature | NO               |
| SAG OPTION  | Minor      | I2C has failed between XM3 and SAG   | 1. Check Ribbon Cable<br>2. Replace SAG   | NO               |
| SAG DELTA MEAN  | Minor      | The voltage of one or more batteries is either too high or low from mean   | 1. Check Batteries<br>2. Replace Batteries                                      | NO               |
| SAG RELAY STUCK   | Minor      | Relay has stuck or 36V or 0V wire is no longer connected   | 1. Check SAG Wires BAT<br>2. Check SAG Wires Unit<br>3. Replace SAG Wires       | NO               |
| STR X MISWIRED  | Minor      | Battery wires are not connected properly   | 1. Check SAG Wires BAT<br>2. Check SAG Wires Unit<br>3. Replace SAG Wires       | NO               |
| SAG NOT CALIBRAT  | Minor      | Calibration data is not or is no longer available  | 1. Replace SAG  | NO               |
| X BAL STAGE   | Minor      | Stage 0 and 1 are normal. Stage 2 shows that the batteries are not of similar capacity. Stage 3-5 trigger check battery alarm to show that there is a major capacity imbalance | 1. Check Batteries<br>2. Replace Batteries                                      | NO               |
| SAG NO HARNESS  | Minor      | Battery wires are not connected properly   | 1. Check SAG Wires BAT<br>2. Check SAG Wires Unit<br>3. Replace SAG Wires       | NO               |

**Table 6-9, Battery Alarms: Classifications, Causes and Corrections**



#### **NOTICE:**

The cause of a psMajor or psMinor alarm can be determined by checking the Discretes table in the Alpha MIB or by viewing the Web page. The cause will have the value of **ALARM**.

# 7.0 Installation

## 7.1 Verifying Power Supply Device Address

Before installing the hardware, provision the DHCP server with the cable modem's CM MAC address. This allows the installation to be verified while the technician is on-site, eliminating the need for a second visit if there are problems with the installation.



### WARNING! ELECTRICAL HAZARD

To reduce the risk of electric shock, completely remove the Inverter Module from the power supply prior to installation. For field installation, use a service power supply to avoid losing power to the load.



### CAUTION!

The DM3.0 Series Transponder is static sensitive. An ESD wrist strap should be worn when installing the transponder.

Before removing the Inverter Module (IM), verify the power supply device address is correct.

The power supply device address must not be set to zero and no two power supplies monitored by a single DM3.0 Series Transponder can have the same address. The power supply must have a unique address to communicate with a system controller. The system controller uses the address as an identifier to query the power supply for information. Each power supply on the same communications bus must be identified with a value between 1 and 5. To verify the power supply's address do the following:

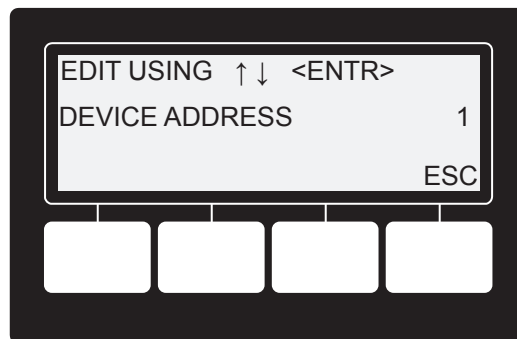

Smart Display Screen

1. Press the PWR key on the Inverter Module twice to access the PWR CNFG Menu.
2. Press the Down or Up key until DEVICE ADDRESS is displayed.
3. If the address is correct (in the range of 1 to 5), skip to Step 7.
4. To change the address, press the Enter key to enter the Edit mode.
5. Press the Up or Down keys until the desired address (1 to 5) is displayed. Remember, each power supply monitored by a single transponder must have a unique address; this may require accessing the menu systems of the additional power supplies and adjusting as applicable.
6. Press the Enter key to load the new address.
7. Press ESC two times to return to the OPERATION NORMAL screen.

## 7.0 Installation, continued

### 7.2 Installation / Replacement Procedure in XM3 Power Supplies

If the XM3 CableUPS has been shipped without a DM3.0 Series Transponder, or the existing module requires removal and replacement, do so via the following procedure:

1. Switch OFF the Inverter Module battery breaker.

 **NOTICE:**

With the battery breaker in the OFF position, the power supply will not go into inverter mode.

2. Unplug all Inverter Module connections (e.g. battery cable, remote temperature sensor).
3. Loosen the two Inverter Module thumbscrews.
4. Slide the Inverter Module out of the power supply.
5. If the Inverter Module is equipped with a transponder, remove it by loosening the two Phillips captive screws.

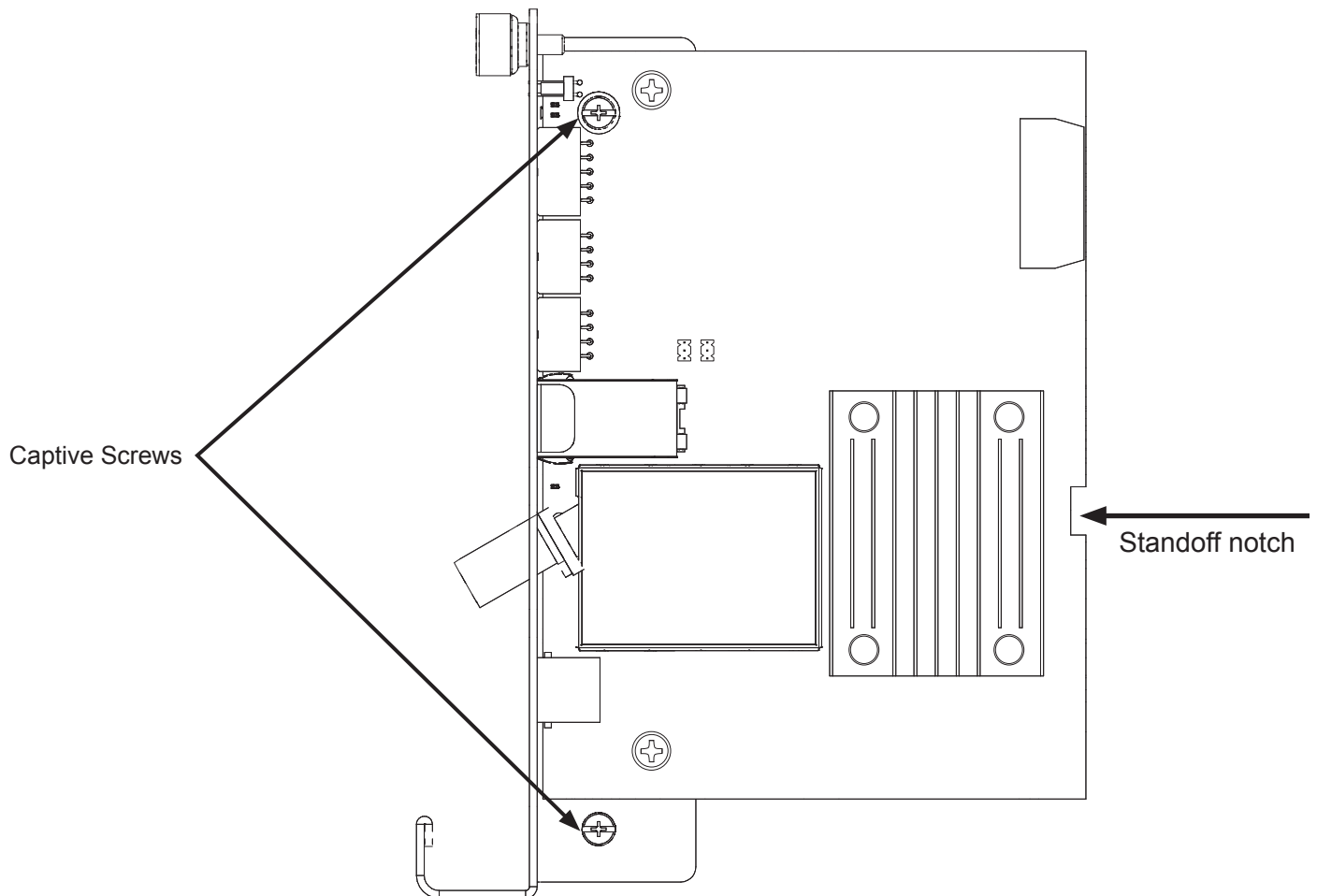

**Fig. 7-1, Captive Screw Locations**

## 7.0 Installation, continued

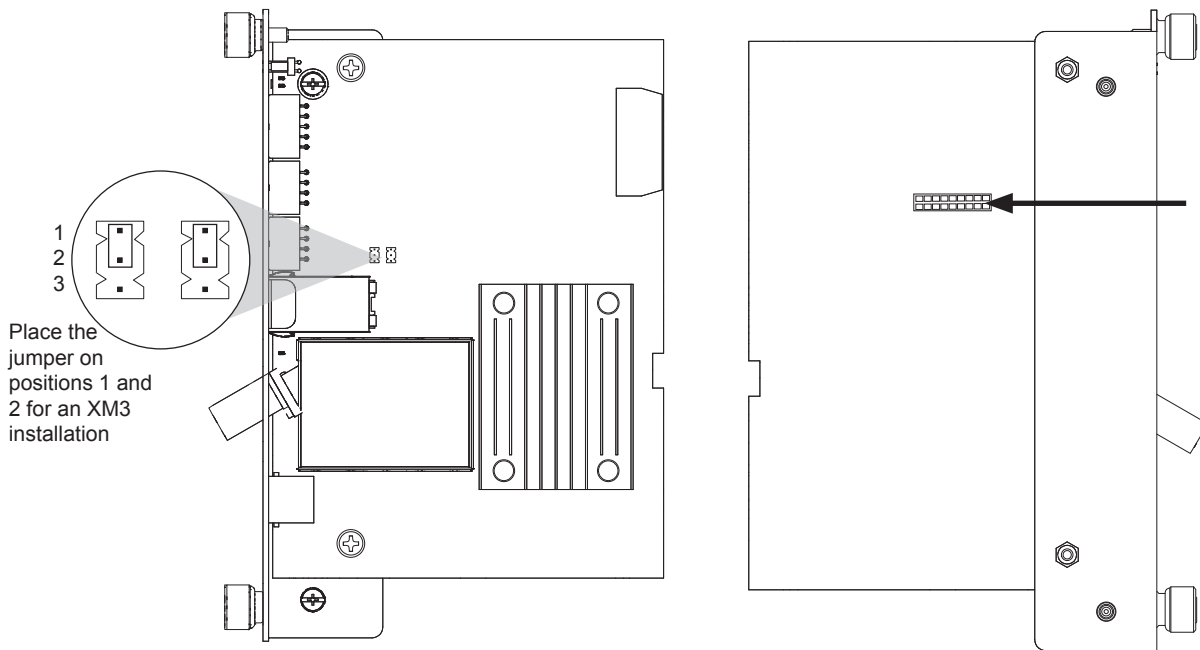

**Fig. 7-2, Jumper Location and the 18-Pin Connector**

6. Verify the jumpers (J10, J11) on the transponder are in the correct position for an XM3 installation (Fig. 7-2).
7. Fit the notch in the DM3.0 circuit board into the standoff mounted in the Inverter Module, align the 18-pin mating connectors on the DM3.0 Series Transponder and the XM3 Inverter Module. Gently push the transponder into the Inverter Module until the 18-pin mating connector is properly seated. The Transponder should be parallel to the Inverter Module.

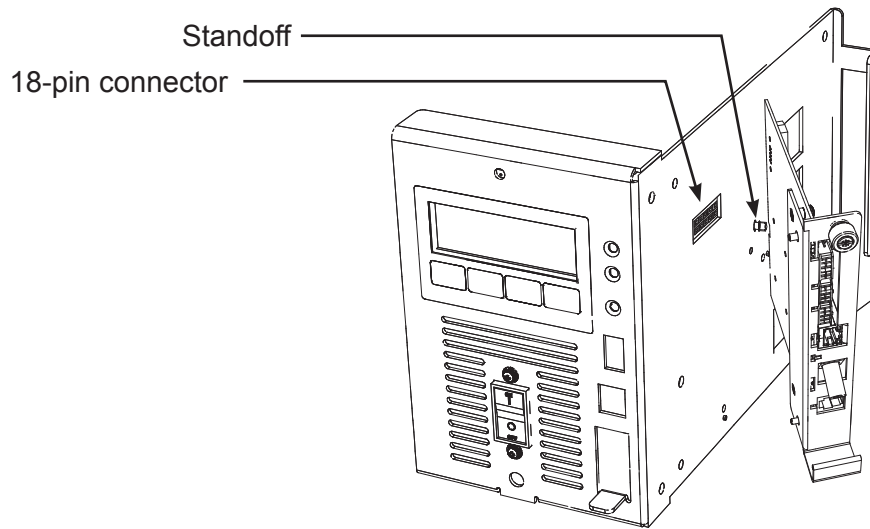
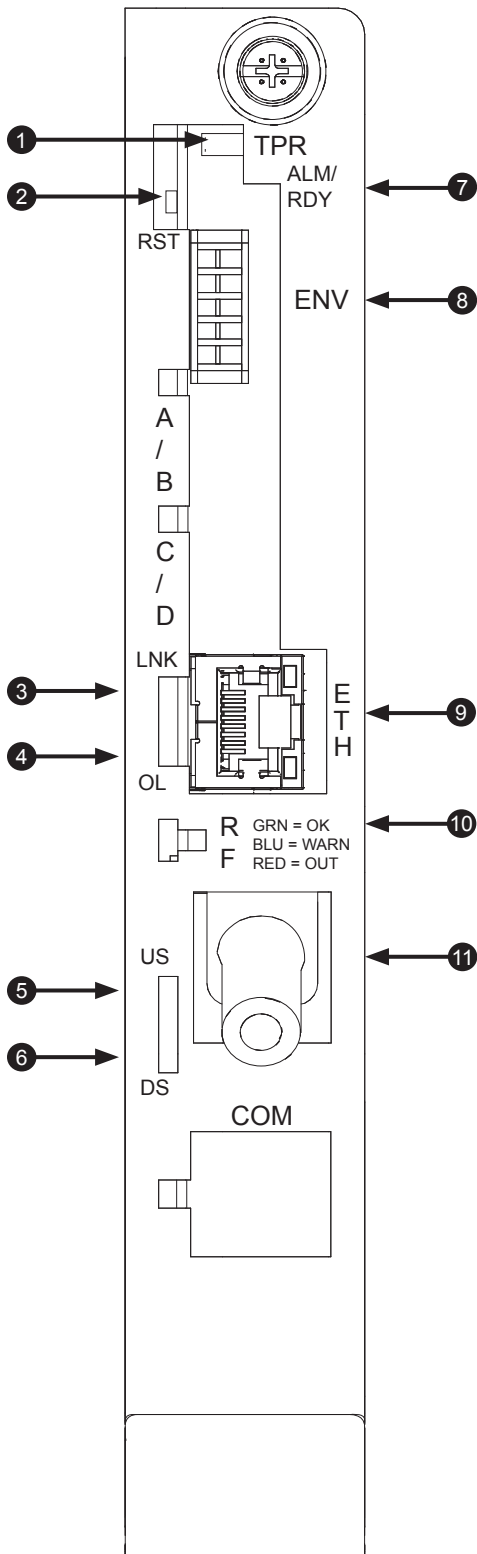

**Fig. 7-3, Connecting the Transponder to the Inverter Module**

8. Fasten the DM3.0 Series Transponder to the Inverter Module by tightening the two captive screws. It is recommended that the screws be tightened alternately, a few turns at a time so the transponder aligns in parallel to the Inverter Module.
9. Reinstall the Inverter Module and tighten the two thumbscrews. Make front panel connections (tamper, temperature sensor, battery sense, RF etc.).
10. If not yet done, record the cable modem MAC address from the XM3 Smart Display COMM Menu and report it to the network manager for network provisioning.



### 7.3 DM3 LEDs and Connections



| DM3 LEDs and Connectors |  |        |                           |   |
|-------------------------|--|--------|---------------------------|---|
| Item                    | LED or Connector                             | Status | Behavior                  | Indication  |
| 1                       | TPR: Tamper Switch Connector                 |        |                           |   |
| 2                       | RST: Reset Button                            |        |                           |   |
| 3                       | LNK: CPE Link Status                         | GRN    | OFF                       | No Ethernet Link  |
|                         |  |        | ON                        | Link on Ethernet Craft Port   |
| 4                       | OL: CPE Activity Status (or Online status)   | GRN    | OFF                       | No Ethernet Communications Activity   |
|                         |  |        | OFF / ON                  | Momentary flashes during CPE communications via the Ethernet Craft Port when connected to a CPE device OR flashes while performing early authentication, IP connectivity, BPI initialization. |
|                         |  |        | ON                        | Online and Operational  |
| 5                       | US: Upstream ranging and registration lock   | GRN    | OFF                       | No power, upstream frequency undetermined   |
|                         |  |        | OFF / ON                  | Power on, downstream locked, upstream frequency ranging, DHCP request in progress   |
|                         |  |        | ON                        | CMTS registration completed   |
| 6                       | DS: Downstream RF Carrier detection and lock | GRN    | OFF                       | No Power / Downstream Carrier   |
|                         |  |        | OFF / ON                  | Power on, downstream carrier frequency searching  |
|                         |  |        | ON                        | Downstream carrier lock   |
| 7                       | ALM / RDY: Alarm and Ready                   | N/A    | OFF                       | No power or malfunctioning Communications Module  |
|                         |  |        | GRN                       | ON  |
|                         |  | RED    | Steady Blinking           | Normal Operation  |
|                         |  |        | Blinking more OFF than ON | Minor Alarm   |
| 8                       | ENV: Environmental Control Connector         |        |                           |   |
|                         | 9 ETH: Ethernet Connection                   |        |                           |   |
| 10                      | RF Power Level Indicator                     | TRI    | OFF                       | No RF Detected  |
|                         |  |        | BLUE                      | Rx / Tx Power at a Warning Level as Set Within the SCTE-HMS Property Table  |
|                         |  |        | GREEN                     | Rx / Tx RF Power Level Within Tolerance   |
|                         |  |        | RED                       | Rx / Tx Power at an Alert Level as Set Within the SCTE-HMS Property Table   |
| 11                      | RF Connection                                |        |                           |   |

Fig. 7-4, DM3 LEDs and Connectors

7.4 DM3X LEDs and Connections

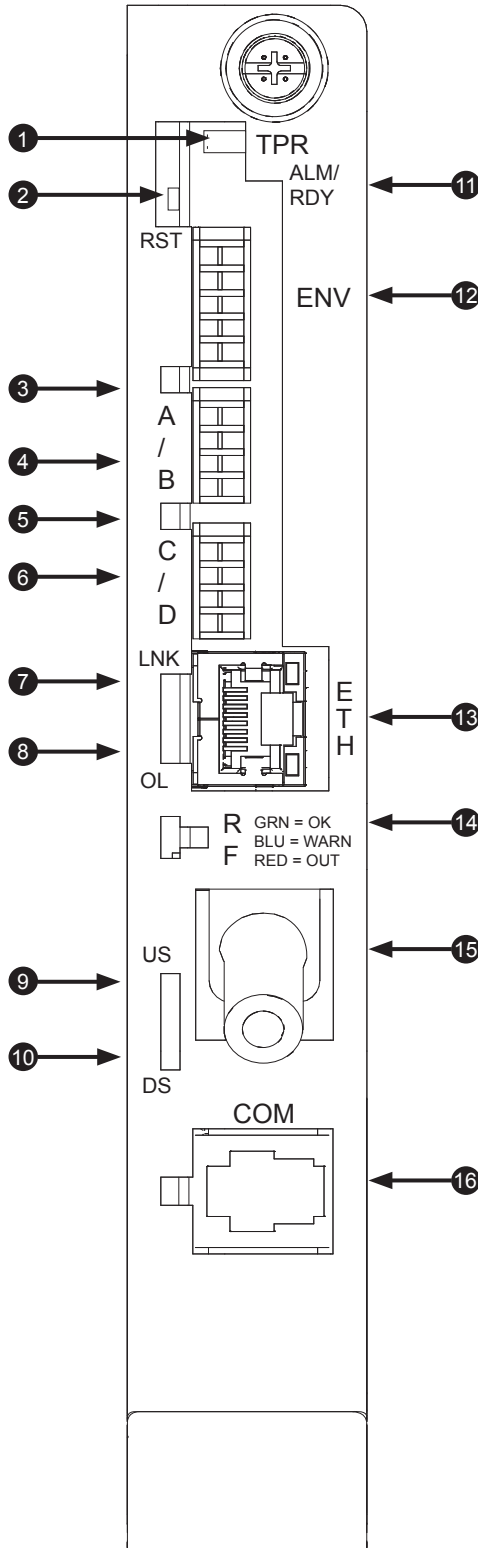

| DM3X LEDs and Connectors |  |             |                 |   |
|--------------------------|--|-------------|-----------------|---|
| Item                     | LED or Connector                             | Status      | Behavior        | Indication  |
| 1                        | TPR: Tamper Switch Connector                 |             |                 |   |
| 2                        | RST: Reset Button                            |             |                 |   |
| 3                        | BAT A / B                                    | GRN         | ON / OFF        | ON (steady) if Battery String(s) Connected Correctly  |
| 4                        | BAT A / B Connector                          |             |                 |   |
| 5                        | BAT C / D                                    | GRN         | ON / OFF        | ON (steady) if Battery String(s) Connected Correctly  |
| 6                        | BAT C / D Connector                          |             |                 |   |
| 7                        | LNK: CPE Link Status                         | GRN         | OFF             | No Ethernet Link  |
|                          |  |             | ON              | Link on Ethernet Craft Port   |
| 8                        | OL: CPE Activity Status (or Online status)   | GRN         | OFF             | No Ethernet Communications Activity   |
|                          |  |             | OFF / ON        | Momentary flashes during CPE communications via the Ethernet Craft Port when connected to a CPE device OR flashes while performing early authentication, IP connectivity, BPI initialization. |
|                          |  |             | ON              | Online and Operational  |
| 9                        | US: Upstream ranging and registration lock   | GRN         | OFF             | No power, upstream frequency undetermined   |
|                          |  |             | OFF / ON        | Power on, downstream locked, upstream frequency ranging, DHCP request in progress   |
|                          |  |             | ON              | CMTS registration completed   |
| 10                       | DS: Downstream RF Carrier detection and lock | GRN         | OFF             | No Power / Downstream Carrier   |
|                          |  |             | OFF / ON        | Power on, downstream carrier frequency searching  |
|                          |  |             | ON              | Downstream carrier lock   |
| 11                       | ALM / RDY: Alarm and Ready                   | N/A         | OFF             | No power or malfunctioning Communications Module  |
|                          |  |             | ON              | Reset of the DM3.0 Series in in process   |
|                          |  | GRN         | Steady Blinking | Normal Operation  |
|                          |  |             | RED             | Blinking more OFF than ON   |
|                          | Blinking more ON than OFF                    | Major Alarm |                 |   |
| 12                       | ENV: Environmental Control Connector         |             |                 |   |
| 13                       | ETH: Ethernet Connection                     |             |                 |   |
| 14                       | RF Power Level Indicator                     | TRI         | OFF             | No RF Detected  |
|                          |  |             | BLUE            | Rx / Tx Power at a Warning Level as Set Within the SCTE-HMS Property Table  |
|                          |  |             | GREEN           | Rx / Tx RF Power Level Within Tolerance   |
|                          |  |             | RED             | Rx / Tx Power at an Alert Level as Set Within the SCTE-HMS Property Table   |
| 15                       | RF Connection                                |             |                 |   |
| 16                       | COM: AlphaBus Communications Connector       |             |                 |   |

Fig. 7-5, DM3X LEDs and Connectors

## 7.5 Connecting the RF Drop



### CAUTION!

Install a grounded surge suppressor (Alpha P/N 162-028-10 or equivalent) - failure to install an appropriate surge suppressor may void the warranty.



### NOTICE:

Alpha Technologies recommends tightening the RF cable connector and the cables attached to the Grounded Surge Protector to a Torque setting of 10in-lb  $\pm$  1in-lb.

Connect the RF drop according to the diagram below. The RF drop must have a properly installed grounded surge suppressor in the power supply enclosure. Recommended downstream RF level is 0 dBmV. Connect any other front panel connections at this time (e.g. battery strings, tamper switch).

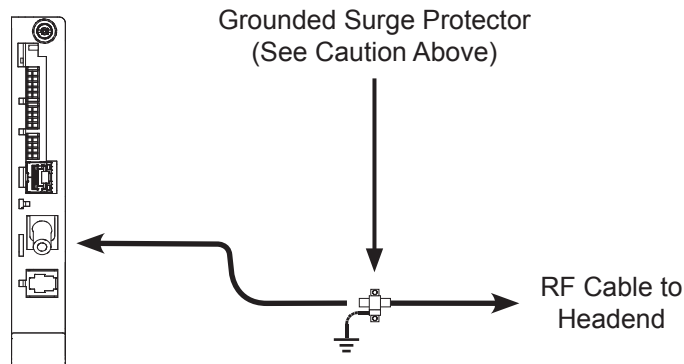

Fig. 7-6, Connecting the RF Drop

## 7.6 Front Panel Connections

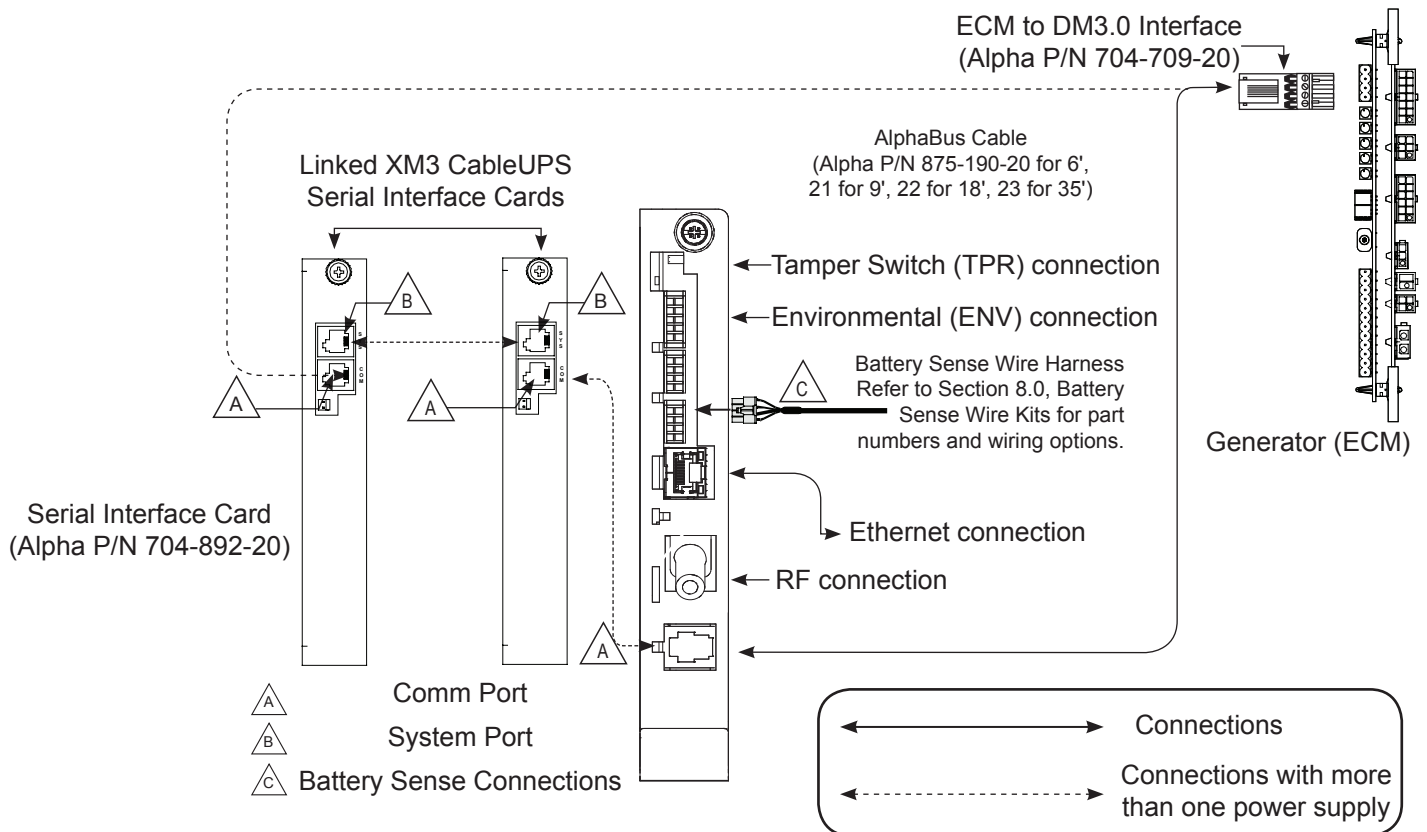

Fig. 7-7, System Interconnection Diagram

## 7.0 Installation, continued

### 7.7 I/O Connections (TPR, ENV)

The Alpha DM3.0 Series Transponders (DM3, DM3X) are all populated with a Tamper interface to report the status of the power supply enclosure door when equipped with the optional tamper switch. The Alpha DM3.0 Series Transponders are populated with the Environmental and I/O Controller interface (referred to in this section as I/O Port) which can be used to monitor and control an array of contact relay devices such as battery heater mats, enclosure moisture sensors and emergency generators.

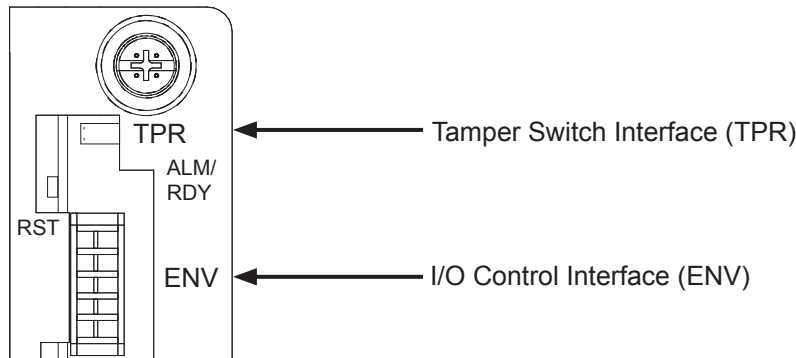



Fig. 7-8 I/O (ENV) and Tamper Switch Interface (TPR) Connection Locations

#### 7.7.1 Tamper (TPR) Switch Interface

The tamper switch interface is designed to report and alarm the status of the power supply enclosure door. The circuit created by the tamper switch is a contact relay, so other contact relay devices can be designed to be monitored through this interface. For example, the Alpha Utility Line Sensor (Alpha P/N 746-399-2X) uses the tamper interface to monitor the Utility outlet to report the presence of line voltage.

 **NOTICE:**

In the OID column of the following table, 'X' denotes power supply device address (Default = 1)

| Tamper (TPR) Switch Specifications |                   |   |  |   |
|------------------------------------|-------------------|---|--|---|
| Function                           | Parameter         | OID   | Values   | Description                               |
| Tamper                             | psTamper          | 1.3.6.1.4.1.5591.1.4.2.1.27.X<br>See Note 1                       | 1 = Closed<br>2 = Open   | Status of Enclosure Door                  |
| Utility Sense                      | psTamper          | 1.3.6.1.4.1.5591.1.4.2.1.27.X                                     | 1 = No Voltage<br>2 = Voltage Present  | Status of Utility Voltage                 |
|                                    | tamperPolarity    | 1.3.6.1.4.1.926.1.3.2.6.1.0                                       | 1 = Report "Open"<br>When Contact Open<br>2 = Report "Open"<br>When Contact Closed | Controls Polarity of "psTamper" Reporting |
| Alarm / Trap                       | psTamper (Closed) | 1.3.6.1.4.1.5591.1.1.3.1.3.13.1.3.6.1.4<br>.1.5591.1.4.2.1.27.X.1 | 1 = Disable<br>2 = enableMajor<br>3 = enableMinor                                  | Alarm Enable for psTamper = Closed        |
| Alarm / Trap                       | psTamper (Open)   | 1.3.6.1.4.1.5591.1.1.3.1.3.13.1.3.6.1.4<br>.1.5591.1.4.2.1.27.X.2 | 1 = Disable<br>2 = enableMajor<br>3 = enableMinor                                  | Alarm Enable for psTamper = "Open"        |

Table 7-1, Tamper (TPR) Switch Specifications

## 7.0 Installation, continued

### 7.7.2 I/O Port Interface

| ENV Connector and Pin Descriptions   |     |  |
|--|-----|--|
| ENV Connector  | Pin | Description  |
|  <p>Back of ENV Connector</p> | 1   | Logic Gnd  |
|  | 2   | 5V +/- 0.5V voltage Shotky Protection – 15mA max. – Relay current drive          |
|  | 3   | Open/Close Control – 0V/15mA sink = Close, 3.3V/0mA = Open                       |
|  | 4   | Open/Close Sense – Pin 4 relay contact short to pin 1 = Close, Pin 4 open = Open |
|  | 5   | Open/Close Sense – Pin 5 relay contact short to pin 1 = Close, Pin 5 open = Open |
|  | 6   | Open/Close Sense – Pin 6 relay contact short to pin 1 = Close, Pin 6 open = Open |
|  | 7   | Open/Close Control – 0V/15mA sink = Close, 3.3V/0mA = Open                       |
|  | 8   | Open/Close Sense – Pin 8 relay contact short to pin 1 = Close, Pin 8 open = Open |
|  | 9   | Not Connected  |
|  | 10  | Not Connected  |

**Table 7-2, ENV Connector and Pin Descriptions**

Steps to configure DM3.0 Series Transponder to monitor I/O device.

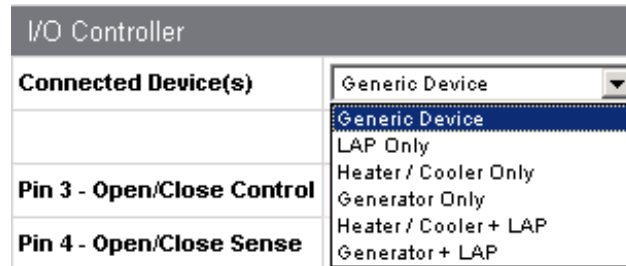

1. Set `atiMgmtSysIoSelect` appropriately (SNMP or Web) for device to monitor.

OID 1.3.6.1.4.1.926.1.3.2.8.1.0

1 = Generic

2 = LAP Only

3 = Heater/Cool Control Only (Heater Mat)

4 = DC Emergency Generator Only

5 = Heater/Cooler + LAP

6 = DC Generator + LAP

The device can be selected through the Web page by navigating to 'Advanced Configuration', 'I/O – Environment' and selecting from the pull-down list

2. Configure alarms (Generic Only – See below section for details).
3. Monitor appropriate SNMP parameters (See each section below for details).

### 7.7.3 Configuring I/O Port Connections

Alpha has created logic for control and reporting of specific devices or combination of devices. The Alpha proprietary SNMP MIB `atiMgmtSysIoSelect`, 1.3.6.1.4.1.926.1.3.2.8.1.0 must be set appropriately before the device status will be correctly reported. The monitored device can also be set through the transponder's "Advanced Configuration - I/O" Web page pull-down. The status of the generic I/O Pins can still be monitored and alarmed via the `SCTE-HMS discretePropertyTable` even when specific devices have been selected.

## 7.0 Installation, continued

| I/O Port Specifications                          |                        |  |
|--|------------------------|--|
| atiMgmtSysloSelect (1.3.6.1.4.1.926.1.3.2.8.1.0) |                        |  |
| MIB Value  | Device                 | Reported Parameter of MIB Branch                 |
| 1  | No Device (Generic)    | I/O Pins Only                                    |
| 2  | LAP Only               | atiMgmtSysloLAPState 1.3.6.1.4.1.926.1.3.2.8.2.0 |
| 3  | Heater Control Only    | atiMgmtSysTempMgr * 1.3.6.1.4.1.926.1.3.2.4      |
| 4  | DC Generator Only      | atiMgmtSysloGenState 1.3.6.1.4.1.926.1.3.2.8.3.0 |
| 5  | Heater Control and LAP | atiMgmtSysloLAPState atiMgmtSysTempMgr *         |
| 6  | Generator and LAP      | atiMgmtSysloLAPState atiMgmtSysloGenState        |

\*MIBs within atiMgmtSysTempMgr branch will report and control will be allowed regardless of the value reported by atiMgmtSysloSelect.

**Table 7-3, I/O Port Specifications**

### 7.7.4 I/O Port: Generic Device

The I/O connector on the transponder allows the headend to remotely monitor and control external contact relay devices. Each input pin can be configured through the SCTE-HMS discretePropertyTable for alarm and SNMP trap generation.

| I/O Port: Generic Device Specifications |                     |  |   |   |
|---|---------------------|--|---|---|
| Function                                | Parameter           | OID  | Values  | Description                                 |
| Input                                   | atiMgmtSysIOPinIn4  | 1.3.6.1.4.1.926.1.3.2.8.21.0                                 | 1 = Contact Open                                  |   |
| Input                                   | atiMgmtSysIOPinIn5  | 1.3.6.1.4.1.926.1.3.2.8.22.0                                 | 1 = Contact Open<br>2 = Contact Closed            | Used to monitor moisture sensor             |
| Input                                   | atiMgmtSysIOPinIn6  | 1.3.6.1.4.1.926.1.3.2.8.23.0                                 | 1 = Contact Open<br>2 = Contact Closed            |   |
| Control                                 | atiMgmtSysIOPinCtrl | 1.3.6.1.4.1.926.1.3.2.8.20.0                                 | 1 = Contact Open<br>2 = Contact Closed            | Open/Close a contact                        |
| Alarm / Trap                            | IOPinIn4 (Open)     | 1.3.6.1.4.1.5591.1.1.3.1.3.13.1.3.6.1.4.1.926.1.3.2.8.21.0.1 | 1 = disable<br>2 = enableMajor<br>3 = enableMinor | Alarm enable when Pin4 contact is Open      |
| Alarm / Trap                            | IOPinIn4 (Closed)   | 1.3.6.1.4.1.5591.1.1.3.1.3.13.1.3.6.1.4.1.926.1.3.2.8.21.0.2 | 1 = disable<br>2 = enableMajor<br>3 = enableMinor | Alarm enable when Pin4 contact is Closed    |
| Alarm / Trap                            | IOPinIn5 (Open)     | 1.3.6.1.4.1.5591.1.1.3.1.3.13.1.3.6.1.4.1.926.1.3.2.8.22.0.1 | 1 = disable<br>2 = enableMajor<br>3 = enableMinor | Alarm enable when Pin5 contact is Open      |
| Alarm / Trap                            | IOPinIn5 (Closed)   | 1.3.6.1.4.1.5591.1.1.3.1.3.13.1.3.6.1.4.1.926.1.3.2.8.22.0.2 | 1 = disable<br>2 = enableMajor<br>3 = enableMinor | Alarm enable when Pin5 contact is Closed    |
| Alarm / Trap                            | IOPinIn6 (Open)     | 1.3.6.1.4.1.5591.1.1.3.1.3.13.1.3.6.1.4.1.926.1.3.2.8.23.0.1 | 1 = disable<br>2 = enableMajor<br>3 = enableMinor | Alarm enable when Pin6 contact is Open      |
| Alarm / Trap                            | IOPinIn6 (Closed)   | 1.3.6.1.4.1.5591.1.1.3.1.3.13.1.3.6.1.4.1.926.1.3.2.8.23.0.2 | 1 = disable<br>2 = enableMajor<br>3 = enableMinor | Alarm enable when Pin6 contact is Closed    |
| Alarm / Trap                            | IOPinCtrl (Open)    | 1.3.6.1.4.1.5591.1.1.3.1.3.13.1.3.6.1.4.1.926.1.3.2.8.20.0.1 | 1 = disable<br>2 = enableMajor<br>3 = enableMinor | Alarm enable when control contact is Open   |
| Alarm / Trap                            | IOPinCtrl (Closed)  | 1.3.6.1.4.1.5591.1.1.3.1.3.13.1.3.6.1.4.1.926.1.3.2.8.20.0.2 | 1 = disable<br>2 = enableMajor<br>3 = enableMinor | Alarm enable when control contact is Closed |

**Table 7-4, I/O Port: Generic Device Specifications**

## 7.0 Installation, continued

### 7.7.5 Connecting a Generic I/O Device

For generic device configurations consult your Alpha representative.

### 7.7.6 Configuring and Monitoring a Generic I/O Device

Set the parameter `atiMgmtSysloSelect 1.3.6.1.4.1.926.1.3.2.8.1.0` to a value of "1" (Generic). Alternatively, navigate to 'Advanced Configuration', 'I/O – Environment' and select "Generic Device" from the pull-down list.

| I/O Controller                    |  |
|-----------------------------------|--|
| <b>Connected Device(s)</b>        | Generic Device   |
|                                   | Generic Device<br>LAP Only<br>Heater / Cooler Only<br>Generator Only<br>Heater / Cooler + LAP<br>Generator + LAP |
| <b>Pin 3 - Open/Close Control</b> |  |
| <b>Pin 4 - Open/Close Sense</b>   |  |

The status of the control and input pins can be monitored through the following OIDs.

|   |  |
|---|--|
| Pin 3 (Control)<br>1.3.6.1.4.1.926.1.3.2.8.20 | 1 = Contact Open<br>2 = Contact Closed |
| Pin 4 (Input)<br>1.3.6.1.4.1.926.1.3.2.8.21   | 1 = Contact Open<br>2 = Contact Closed |
| Pin 5 (Input)<br>1.3.6.1.4.1.926.1.3.2.8.22   | 1 = Contact Open<br>2 = Contact Closed |
| Pin 6 (Input)<br>1.3.6.1.4.1.926.1.3.2.8.23   | 1 = Contact Open<br>2 = Contact Closed |

Voltage to drive Pin 3 is managed through the following SNMP OID.

|  |                   |
|--|-------------------|
| <code>atiMgmtSystempCtrl</code><br>1.3.6.1.4.1.926.1.3.2.4.1 | 1 = Off<br>5 = On |
|--|-------------------|

The SCTE-HMS `discretePropertyTable` can be configured to generate SNMP traps based upon the desired contact state of any of the I/O input or control pins (see Table 7-3).

## 7.0 Installation, continued

### 7.7.7 I/O Port: Heater Mat Control

**NOTICE:**

The Heater Control MIBs will continue to report regardless of atiMgmtSysloSelect value, but the Web page will only display Heater Control status if atiMgmtSysloSelect is set to “3” or “5.”

A battery heater mat controller may be managed through the following set of parameters within the ‘atiMgmtSysTempMgr’ MIB branch.

| I/O Port: Heater Mat Control Specifications               |        |  |   |
|---|--------|--|---|
| Parameter   | Access | Values                                 | Description   |
| atiMgmtSysTempCtrl<br>1.3.6.1.4.1.926.1.3.2.4.1.0         | RW     | 1 = Off<br>2 = Switch on Timer         | Starts or stops the heater mat activation timer   |
| atiMgmtSysTempStatus<br>1.3.6.1.4.1.926.1.3.2.4.2.0       | R      | 1 = Contact Open<br>2 = Contact Closed | The heater mat is activated when this parameter reports “2”   |
| atiMgmtSysTempTimer<br>1.3.6.1.4.1.926.1.3.2.4.7.0        | RW     | 0..1440 (Default = 30)                 | The number of minutes the heater mat will stay on when timer is started   |
| atiMgmtSysTempCountdown<br>1.3.6.1.4.1.926.1.3.2.4.8.0    | R      | 0..1440                                | Number of minutes remaining on timer  |
| atiMgmtSysTempStatusInvert<br>1.3.6.1.4.1.926.1.3.2.4.9.0 | RW     | 1 = No invert (default)<br>2 = Invert  | The manufacturer of the mat control block created some models where the polarity is reversed (Open vs closed). If these devices are deployed then this parameter will need to be set to “2” |

Table 7-5, I/O Port: Heater Mat Control Specifications



## 7.0 Installation, continued

### 7.7.8 Connecting the Battery Heater Mat Controller

Power to the heater mat is provided via a customer-supplied controller plugged into the power outlet inside the enclosure. A cable connects the controller to the ENV (Environmental) connector on the transponder. The connection procedure is shown below.

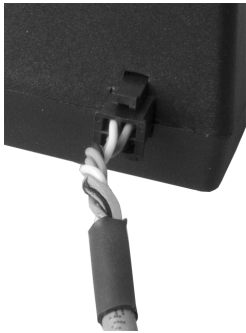

Connect the 4-pin connector from the controller cable into the base of the Heater Mat Controller.

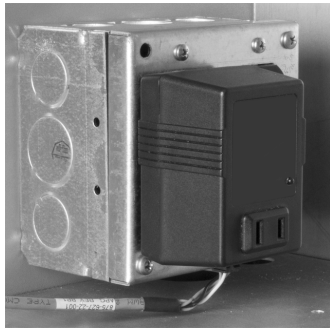

Plug the controller into the power outlet.

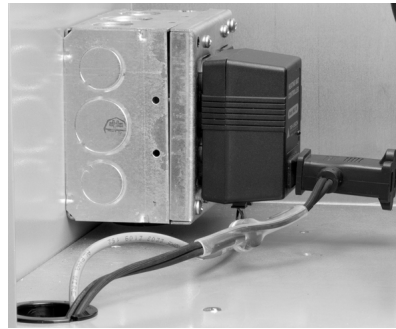

Plug the Heater Mat into the controller.

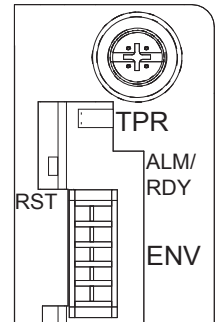

Plug the 10-pin connector into the ENV connector.

Once the connection has been made, Environmental Control Management can be configured using an SNMP MIB browser as indicated in the following tables. The Environmental Control MIB section begins at `atIMgmtSysTempMgr` (1.3.6.1.4.1.926.1.3.2.4). Status of the Environmental Control is also available via the Communications Module's Web page by navigating to 'Advanced Configuration', 'I/O – Environment'. Ensure the 'Heater/Cooler Only' is selected from the drop-down list.

| I/O Controller                    |                       |
|-----------------------------------|-----------------------|
| <b>Connected Device(s)</b>        | Generic Device        |
|                                   | Generic Device        |
|                                   | LAP Only              |
| <b>Pin 3 - Open/Close Control</b> | Heater / Cooler Only  |
|                                   | Generator Only        |
| <b>Pin 4 - Open/Close Sense</b>   | Heater / Cooler + LAP |
|                                   | Generator + LAP       |

## 7.0 Installation, continued

### 7.7.9 Configuring the Battery Heater Mat Controller

In this example, values are written to their respective OIDs to set temperatures, control mode and status reporting.

| Heater Mat OIDs and Functionality                              |   |
|--|---|
| Set these OIDs to the Specified Value                          | Functionality   |
| atiMgmtSysTempTemperature<br>(1.3.6.1.4.1.926.1.3.2.4.5) to 5  | Heater turns on at 5°C  |
| atiMgmtSysTempHysteresis<br>(1.3.6.1.4.1.926.1.3.2.4.6) to 3   | 3°C of permitted controller overshoot (in this case, would turn off at 8°C) |
| atiMgmtSysTempCtrl<br>(1.3.6.1.4.1.926.1.3.2.4.1) to 3         | Battery temperature sensor used to control heater setpoint                  |
| atiMgmtSysTempMode<br>(1.3.6.1.4.1.926.1.3.2.4.3) to 1         | Places controller in heater mode  |
| atiMgmtSysTempActiveState<br>(1.3.6.1.4.1.926.1.3.2.4.4) to 1  | Drive pin to the temperature device will go low when heater is on           |
| atiMgmtSysTempStatusInvert<br>(1.3.6.1.4.1.926.1.3.2.4.9) to 1 | Sets the polarity of the feedback signal from the temperature device        |

**Table 7-6, Heater Mat OIDs and Functionality**

During operating, the following MIB points will report the current temperature and whether the heater is on or off.

| Heater Mat MIB Reports  |                                    |
|---|------------------------------------|
| SNMP MIB Point  | Data                               |
| atiMgmtSysTempStatus<br>(1.3.6.1.4.1.926.1.3.2.4.2)             | Temperature device ON or OFF       |
| atiBBSysViewBatteryTemperature<br>(1.3.6.1.4.1.926.1.4.1.1.3.5) | Battery temperature (in degrees C) |

**Table 7-7, Heater Mat MIB Reports**

### 7.7.10 I/O Port: Emergency DC Generator (GEN)

Generator through the I/O or “ENV” port on the front of the transponder.

See the DCX3000/DCX2000 Remote Status Monitoring (RSM) Assembly Kit Field Installation Guide, p/n 746-379-C0.

## 7.0 Installation, continued

### 7.7.11 Configuring and Monitoring the DC Emergency Generator

Set the parameter `atiMgmtSysloSelect 1.3.6.1.4.1.926.1.3.2.8.1.0` to a value of “4” (Generator). Alternatively, navigate to ‘Advanced Configuration’, ‘I/O – Environment’ and select “Generator Only” from the pull-down list.

| I/O Controller                    |                       |
|-----------------------------------|-----------------------|
| <b>Connected Device(s)</b>        | Generic Device        |
|                                   | Generic Device        |
|                                   | LAP Only              |
| <b>Pin 3 - Open/Close Control</b> | Heater / Cooler Only  |
|                                   | <b>Generator Only</b> |
| <b>Pin 4 - Open/Close Sense</b>   | Heater / Cooler + LAP |
|                                   | Generator + LAP       |

The status of the Generator can be monitored through I/O – Environment web page or via the SNMP MIB `atiMgmtSysloGenState 1.3.6.1.4.1.926.1.3.2.8.3.0`.

| I/O Port: Heater Mat Control Specifications   |  |
|---|--|
| Value List  | Description  |
| <b>atiMgmtSysloGenState (1.3.6.1.4.1.926.1.3.2.8.3.0)</b>                                       |  |
| <code>notInstalled(1)</code>  | This indicates that <code>atiMgmtSysloSelect</code> has not been set to a value of 4 (Generator).                                      |
| <code>genOff(2)</code>  | The generator has been detected but it is not powering the load.   |
| <code>genRunning(3)</code>  | The generator is present and it is powering the load.  |
| <code>genNotDetected(4)</code>  | <code>atiMgmtSysloSelect</code> has not been set to “4” (Generator) but the Generator is not detected.                                 |
| <b>atiMgmtSysloGenTimePowering (1.3.6.1.4.1.926.1.3.2.8.3.0)</b>                                |  |
| Time (Minutes)  | Increments when <code>atiMgmtSysloGenState</code> = 3; resets to “0” when <code>atiMgmtSysloGenState</code> changes to any other value |
| Both of the above parameters can be alarmed through the SCTE-HMS <code>propertyIdent</code> MIB |  |

**Table 7-8, Generator Monitoring Values**

# 8.0 Battery Sense Wire Kits

## 8.1 36V Single and Dual Strings

Transponder Battery Sense Wire Kits are required for individual battery voltage monitoring when the XM3 SAG option is not installed. For XM3 power supplies with the SAG option, it is recommended to use the specific SAG wire kits or the SAG adapter kits to accommodate any existing Transponder Battery Sense Wire Kits. Otherwise, a SAG “No Harness” alarm will be generated if the Battery Sense Wire Kits are connected to the Transponder battery connections (A/B or C/D) instead of the SAG connector.

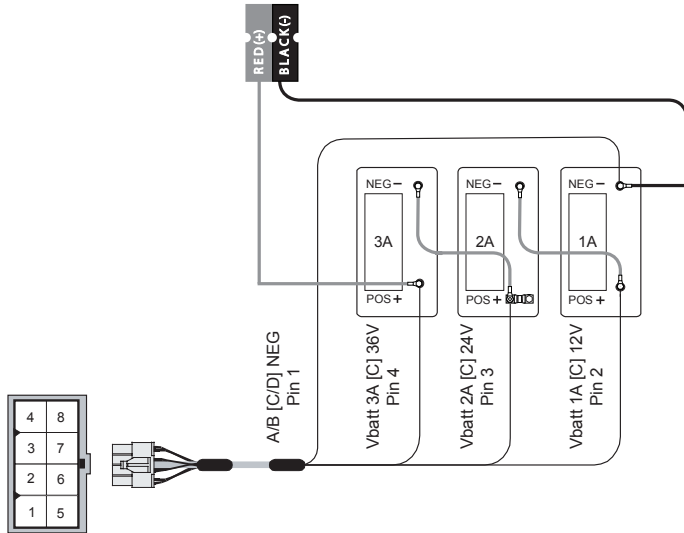

Sense Wire Kits:

- Alpha P/N: 874-842-21 (6')
- Alpha P/N: 874-842-27 (9')

Fig. 8-1 36V System, Single String

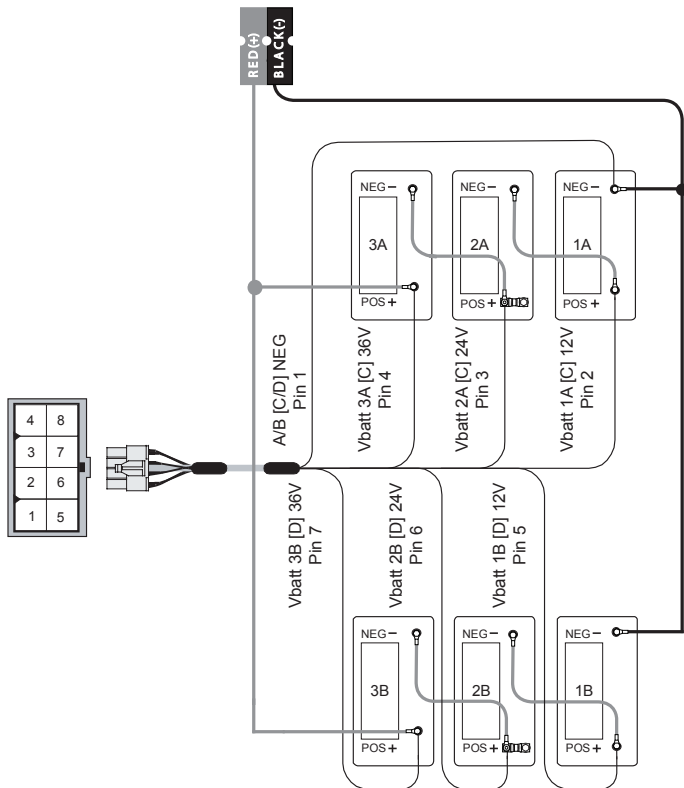

Sense Wire Kits:

- Alpha P/N: 874-842-20 (6')
- Alpha P/N: 874-842-28 (9')

Fig. 8-2, 36V System, Dual String

# 9.0 Start Up and Verification

## 9.1 Initial Start Up and Local Verification

To confirm successful hardware installation before leaving the installation site, verify network connectivity and correct hardware interconnection.

To Verify Network Connectivity:

The DS and REG LEDs on the front of the DM3.0 Series Transponder should be ON solid green. This indicates successful registration with the headend. In addition, the RF LED should also be ON solid green indicating proper RF power levels and the ALM/RDY LED should be blinking green for normal operation.

With the DM3.0 Series Transponder used in conjunction with the XM3-HP power supply, network connectivity can be verified via the COMM menu on the XM3 Smart Display. The following provides a list of parameters available on the XM3 Smart Display populated with sample values. Important communication parameters such as the cable modem IP address, upstream and downstream power levels can be viewed on the COMM-GENERAL menu selection to confirm network connectivity. If no RF power is detected at the RF connector, a COMM - FAULT menu will populate in the COMM menu.

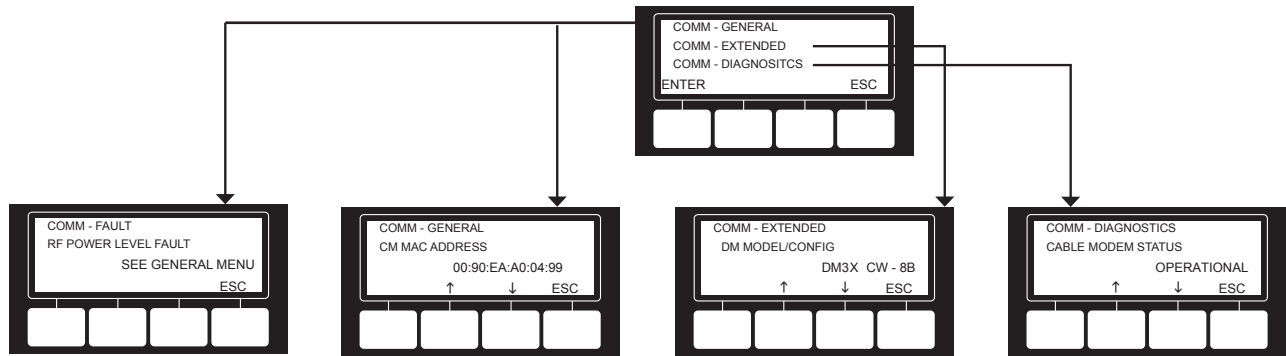

NOTE: COMM-FAULT Menu appears only if there is no RF connection or RF interruption occurs.

| COMM GENERAL         |                   |
|----------------------|-------------------|
| CM MAC ADDRESS       | 00:90:EA:A0:04:99 |
| CM IP ADDRESS        | 192.196.203.101   |
| CM IPV6 ADR PREFIX*  | 2001:123:456:789  |
| CM IPV6 ADR POSTFIX* | 111:222:333:3434  |
| CPE MAC ADDRESS*     | 00:90:EA:A0:05:01 |
| CPE IP ADDRESS*      | 192.168.200.100   |
| CM RECEIVE POWER     | -12.9dBmV         |
| CM TRANSMIT POWER    | 34.5dBmV          |
| DOWNSTREAM SNR       | 33.8dB            |

| COMM - EXTENDED      |                     |
|----------------------|---------------------|
| DM MODEL/CONFIG      | DM3 X CW-8B         |
| DM FIRMWARE VERSION  | 4.4.9.0_03.02_NA    |
| SYSTEM NAME          | ABC123 CABLE        |
| SYSTEM CONTACT       | JOHN DOE            |
| SYSTEM LOCATION      | 123 BAKERVIEW       |
| COMMON LOGICAL ID    | 12345-3767 ALPHAWAY |
| DOCSIS CONFIG FILE   | ALPHA_DM33.CM       |
| DM SERIAL NUMBER     | A00499              |
| SYSTEM DEVICES 3/7** | IPU-1 SAG-1 DOC-1   |
| SYSTEM DEVICES 6/7** | XM3-1 APP-1 BTQ-1   |
| SYSTEM DEVICES 7/7** | UTL-1               |
| CABLEWARE SERVER IP* | 192.168.200.151     |

| COMM - DIAGNOSTICS   |                    |
|----------------------|--------------------|
| CABLE MODEM STATUS   | OPERATIONAL        |
| SYSTEM UPTIME        | 3 DAYS 05H:16M:59S |
| DOWNSTREAM FREQUENCY | 300.000 MHZ        |
| DOWN MODULATION TYPE | 256 QAM            |
| UPSTREAM FREQUENCY   | 15.000 MHZ         |
| T3 TIMEOUTS          | 80360              |
| T4 TIMEOUTS          | 51                 |
| CODEWORD ERROR RATIO | 8.20%              |
| MICROREFLECTIONS     | -5 DBC             |
| CM RESETS            | 10                 |
| CM LOST SYNCs        | 5                  |
| LAST SNMP QUERY      | Date/Time          |

\*NOTE: Some menu items may not appear depending on the options installed

\*\*NOTE: System Device menu items are internal Alpha diagnostic codes. The System Devices menu items will populate based on the option cards (SAG, APP, DOC) installed and the number of external devices added to a power system such as multiple XM3s and/or AlphaGen.

Fig. 9-1, XM3 Smart Display Screens

## 9.0 Start Up and Verification, continued

Connect a computer's network port to the transponder's Ethernet port using a standard network cable. Launch an Internet browser and enter 192.168.100.1 into the address. The transponder will return the Web page shown below. Click on General to display the key communications parameters including system uptime, IP provisioning mode (IPv4, IPv6 & MDD), upstream and downstream power levels and the cable modem's IP address, which confirms connectivity.

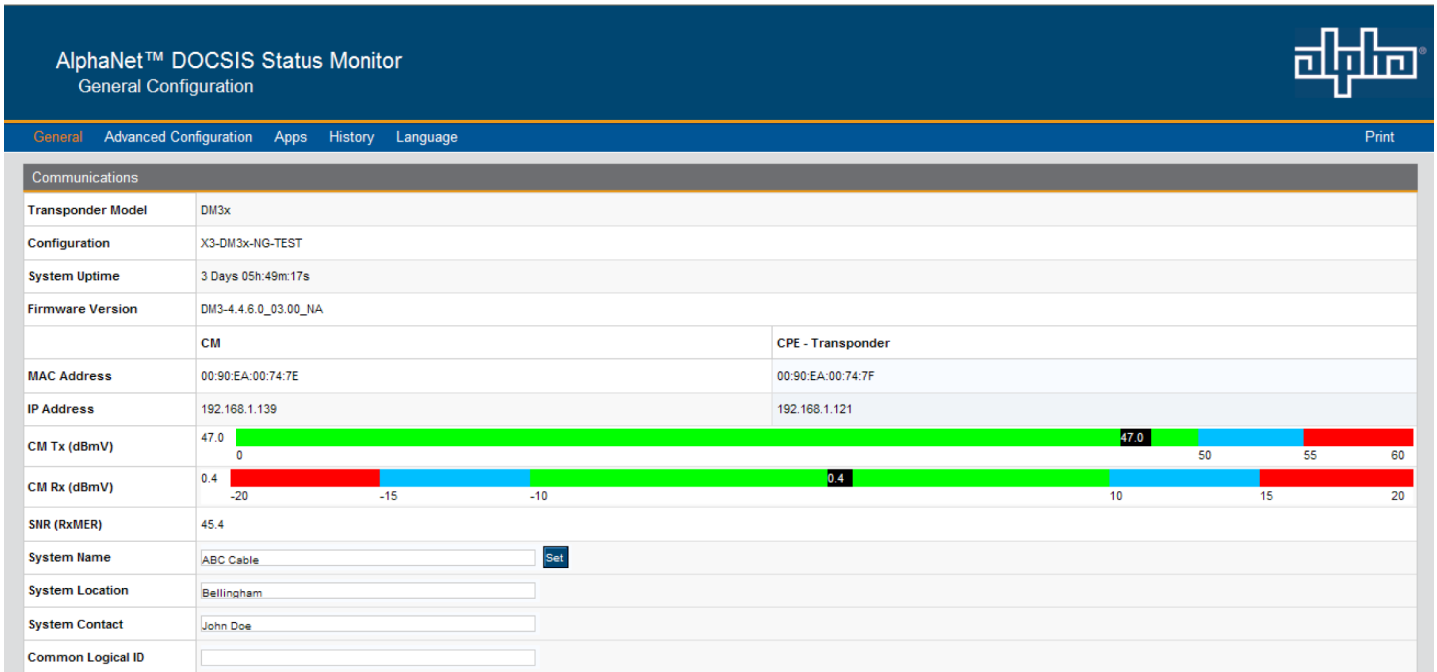

Fig. 9-2, Communications Section - General Page

## 9.0 Start Up and Verification, continued

### 9.2 Verifying Correct Hardware Interconnection



#### **NOTICE:**

The DM3X model provides both BAT A/B and BAT C/D LED indicators and battery harness connectors (supports a maximum 4 battery strings).

The BAT A/B and BAT C/D LED indicators on the front panel of the DM3X unit should illuminate solid green once the battery wiring harnesses are correctly installed. A system with multiple strings must use String A as the first string, B as the second, C as the third and D as the fourth.

From the Power Supplies and Batteries section of General tab of the DM3X Web page, the following screen will be visible and the parameters shown will be available for viewing and verification. To test hardware interconnection using the Ethernet port, verify valid values for Output Voltage, Output Current and individual battery voltages.

| Power Supplies                   |                                   |               |               |
|----------------------------------|-----------------------------------|---------------|---------------|
|                                  | Device 1                          |               |               |
| Model                            | ALPHA/PS MODEL NOT SET            |               |               |
| Firmware                         | V1.06.0                           |               |               |
| Major Alarm                      |                                   | OK            |               |
| Minor Alarm                      |                                   | OK            |               |
| Operational Mode                 | LINE                              |               |               |
| Charger Mode                     | Float                             |               |               |
| Input Voltage (V)                | 120.00                            |               |               |
| Inverter Status                  |                                   | OFF           |               |
| Time Since Last Standby Event    | 0 Days, 0 Hrs, 0 Mins and 0 Secs  |               |               |
| Last Standby Event Duration      | 0 Days, 0 Hrs, 10 Mins and 8 Secs |               |               |
| Self Test                        | Start Test                        |               |               |
| Tamper                           |                                   | Closed        |               |
| Output Voltage (V)               | 87.00                             |               |               |
| Output 1 Current (A)             | 11.60                             |               |               |
| Output 2 Current (A)             | 0.00                              |               |               |
| Batteries                        |                                   |               |               |
| Battery String Runtime Remaining | Calculating                       |               |               |
| Battery Balancing                | Balancing String A                |               |               |
| Battery Temperature (°C)         | 15                                |               |               |
| Total String Voltage (V)         | 41.20                             |               |               |
|                                  | Battery 1 (V)                     | Battery 2 (V) | Battery 3 (V) |
| String A                         | 13.90                             | 13.90         | 13.90         |
| String B                         | 13.90                             | 13.90         | 13.80         |

Fig. 9-3, Power Supply Section - General Page

### 9.3 System Status Indicators and Reset Button

As viewed from the front of the unit, the DM3.0 Series Transponder utilizes LEDs to indicate system status. During system start up, the LEDs will first blink momentarily then indicate the current status of a variety of parameters on the DM3.0 Series Transponder. The LEDs indicate alarms, RF power level status, battery string connectivity and communications activity with the network. A description of each LED follows.

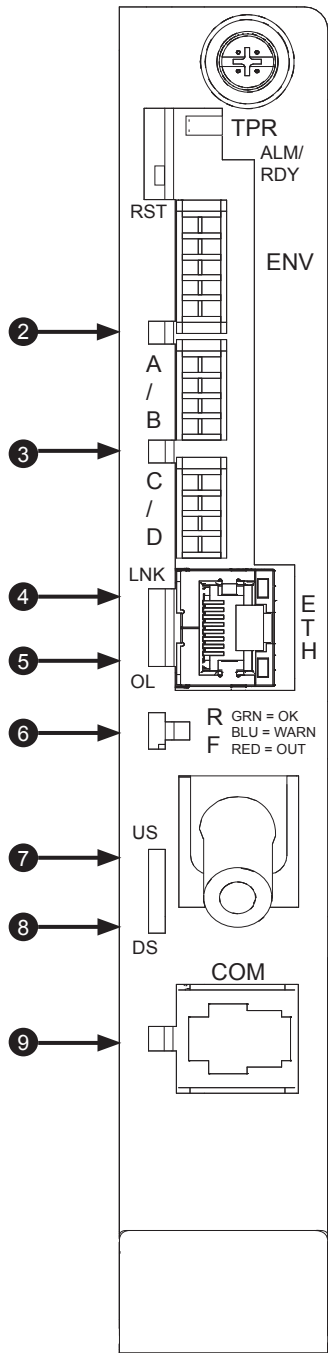

| LED Functionality and Indications            |  |          |                           |   |   |
|--|--|----------|---------------------------|---|---|
| Item   | LED or Connector                           | Status   | Behavior                  | Indication  |   |
| 1  | ALM / RDY: Alarm and Ready                 | N/A      | OFF                       | No power or malfunctioning Communications Module  |   |
|  |  | GRN      | ON                        | Reset of the DM3.0 Series in process  |   |
|  |  |          | Steady Blinking           | Normal Operation  |   |
|  | RED  | RED      | Blinking more OFF than ON | Minor Alarm   |   |
|  |  |          | Blinking more ON than OFF | Major Alarm   |   |
| 2  | BATT A / B                                 | GRN      | ON / OFF                  | ON (steady) if Battery String(s) Connected Correctly  |   |
| 3  | BATT C / D                                 | GRN      | ON / OFF                  | ON (steady) if battery string(s) connected correctly  |   |
| 4  | LNK: CPE Link Status                       | GRN      | OFF                       | No Ethernet Link  |   |
|  |  |          | ON/OFF                    | Link on Ethernet Craft Port   |   |
| 5  | OL: CPE Activity Status (or Online Status) | GRN      | OFF                       | No Ethernet Communications Activity   |   |
|  |  |          | OFF / ON                  | Momentary flashes during CPE communications via the Ethernet Craft Port when connected to a CPE device OR flashes while performing early authentication, IP connectivity, BPI initialization. |   |
|  |  |          | ON                        | Online and Operational  |   |
| 6  | RF Power Level Indicator                   | TRI      | OFF                       | No RF Detected  |   |
|  |  |          | BLUE                      | Rx / Tx Power at a Warning Level as Set Within the SCTE-HMS Property Table  |   |
|  |  |          | GREEN                     | Rx / Tx RF Power Level Within Tolerance   |   |
|  |  |          | RED                       | Rx / Tx Power at an Alert Level as Set Within the SCTE-HMS Property Table   |   |
|  |  |          | GRN                       | OFF   | No power, upstream frequency undetermined   |
|  |  |          |                           | OFF / ON  | Power on, downstream locked, upstream frequency ranging, DHCP request in progress |
|  | US: Upstream ranging and registration lock | GRN      | ON                        | CMTS registration completed   |   |
|  |  |          | GRN                       | OFF   | No Power / Downstream Carrier   |
| DS: Downstream RF Carrier detection and lock | GRN  | OFF / ON |                           | Power on, downstream carrier frequency searching  |   |
|  |  | ON       |                           | Downstream carrier lock   |   |
| 9  | COM: AlphaBus Communications               | GRN      | OFF                       | No AlphaBus Communications  |   |
|  |  |          | OFF / ON                  | Momentary Flashes - AlphaBus Port Communications Active   |   |

Fig. 9-4, LED Functionality and Indications



## 9.0 Start Up and Verification, continued

### 9.3.1 Detailed LED Descriptions

After power is applied or a reset occurs, all LEDs will flash in certain patterns indicating the cable modem chipset is starting or restarting. Once it is ready, it will begin the DOCSIS requirement of searching for the downstream frequency lock and the LEDs will follow the detailed descriptions below.

#### ALM/RDY - Alarm/Ready

During normal operation, this LED blinks GREEN, indicating a heartbeat pulse from the processor. The frequency of flashing by this LED provides a visual alert for power supply discrete major and minor alarms, if configured in the property and discrete property tables of the SCTE-HMS MIB. The ALM LED (RED) is factory defaulted OFF. Refer to Section 6.2.3, General Power Supply Alarms for information on configuring the DM3.0 Series Transponder for active monitoring and alarming. If an event triggers an HMS alarm, the ALM/RDY LED blinks RED according to the alarm type until the alarm has been resolved. For a minor alarm, the frequency of flashing (RED) will be more OFF than ON and for a major alarm the frequency of flashing will be (RED) more ON than OFF. If there are multiple active alarms, including one or more major alarms with one or more minor alarms, the major alarm will take precedence in terms of the indication.

#### DS - Downstream Communication

This LED indicates the state of the CM's attempt to gain a downstream signal. This process may take several seconds, depending on how long it takes the CM to locate a carrier signal and lock onto a channel. The LED flashes while searching for the downstream DOCSIS channel and is on solid when the downstream channel is locked.

#### US - CM Registration

Once a downstream channel has been negotiated between the CM and CMTS, the modem attempts to register with the DHCP server and obtain the Configuration File. This LED flashes while the process takes place. Once a ranging status of 'success' has been received, the LED will remain on solid. This is the best indication that the DM3.0 Series Transponder is communicating with the CMTS in the headend.

#### OL - Network Communication Status

The Ethernet link LED remains ON when there is an active connection on the Ethernet port (e.g., a computer is connected for local diagnostics). Momentary flashes during CPE communications via the Ethernet Craft Port when connected to a CPE device OR flashes while performing early authentication, IP connectivity, BPI initialization.

#### LNK - CPE Activity

The CPE activity LED flashes to indicate that data is being transmitted or received between the DM3.0 Series Transponder and a network device.

## 9.0 Start Up and Verification, continued

### RF Power

The RF Power LED utilizes a tricolor LED to provide the installer a quick verification of the modem transmit (Tx) and receive (Rx) RF power levels. The RF PWR LED will illuminate green when both the cable modem Tx and cable modem Rx RF power levels are within the range as specified in the SCTE-HMS PropertyTable. The LED indicator illuminates blue when Rx and/or Tx levels are within the warning range as specified by the SCTE-HMS PropertyTable. The LED indicator illuminates red when Rx and/or Tx levels are outside the range as specified by the SCTE-HMS PropertyTable.

Refer to the following table for default ranges in the SCTE-HMS PropertyTable:

| SCTE-HMS Property Table |  |              |      |     |      |      |          |
|-------------------------|--|--------------|------|-----|------|------|----------|
|                         | Parameter  | alarm Enable | HiHi | Hi  | Lo   | LoLo | Deadband |
| Rx                      | docsIfDownChannelPower<br>(OID:1.3.6.1.2.1.10.127.1.1.1.1.6) | 00<br>(0F*)  | 150  | 100 | -100 | -150 | 15       |
| Tx                      | docsIfCmStatusTxPower<br>(OID:1.3.6.1.2.1.10.127.1.2.2.1.3)  | 00<br>(0C*)  | 550  | 500 | 00   | 00   | 15       |

**Table 9-1, SCTE-HMS Property Table**

By default, alarmEnable is set to 00 (disabled) to prevent unwanted SNMP traps but the LED behavior will function as if the alarmEnable were set to the values in the above table. If the alarmEnable bits are set to anything other than 00, the LEDs will then follow the behavior of the desired enable bit setting.

The above default values translate into the following RF Power LED color ranges:

| RF Power LED Color Ranges |                           |                 |
|---------------------------|---------------------------|-----------------|
| LED Color                 | Rx Range (dBmV)           | Tx Range (dBmV) |
| Green                     | +10 to -10                | 0 to +50        |
| Blue                      | +15 to +10 and -10 to -15 | +50 to +55      |
| Red                       | >+15 and <-15             | >+55            |

**Table 9-2, RF Power LED Color Ranges**

In addition to the above SCTE-HMS PropertyTable entries, the Tx and Rx levels displayed on the transponder Web page will each provide colored indicator bars that correlate to the RF LED and SCTE-HMS PropertyTable thresholds.

## 9.0 Start Up and Verification, continued

### RF Power

The current RF level status for both the Rx and Tx will be displayed on the colored scale highlighted in black, providing verification of modem RF power levels. Refer to the figure below for an example of the RF power level indicator bars on the Web page.

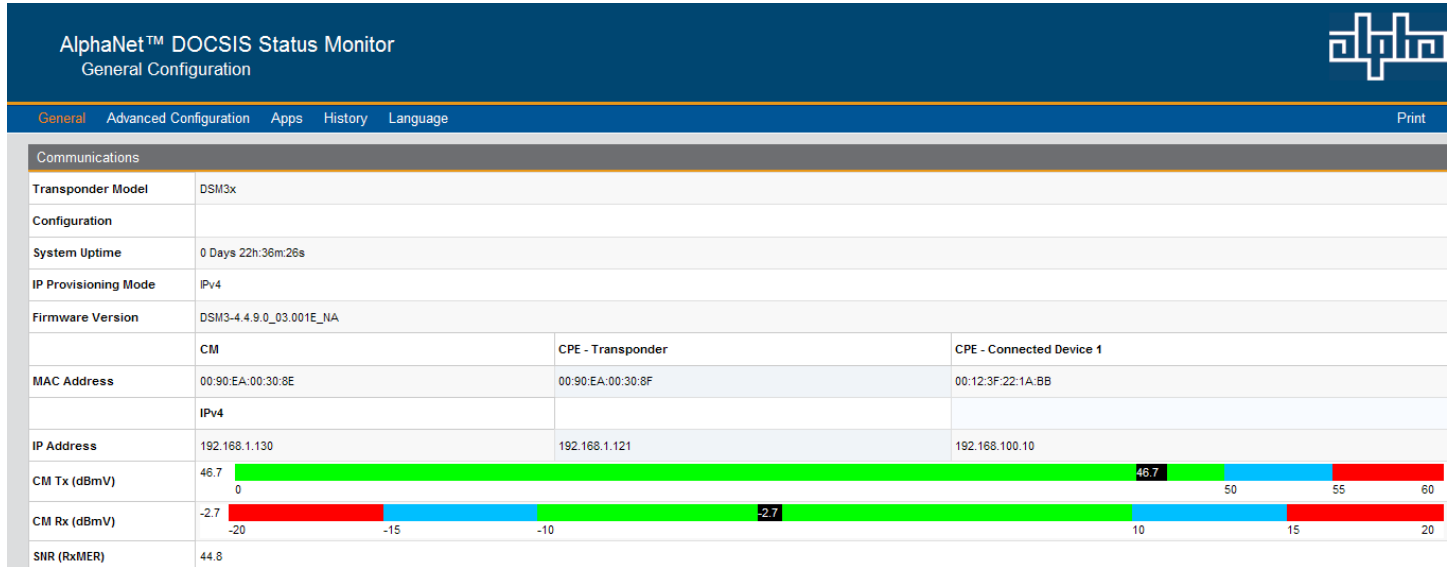

**Fig. 9-5, Transponder Web Page, RF Power Level Indicators**

### Configuring the RF Power LED - Custom Settings

If desired, the RF Power Level ranges for the RF Power LED may be customized via SNMP by adjusting the HiHi, Hi, Lo, LoLo values for the docsIfDownChannelPower and docsIfCmStatusTxPower in the SCTE-HMS Property Table (OID:1.3.6.1.4.1.5591.1.1.1). Be careful not to exceed the RF Input Power and Output Power range specifications of the DM3.0 Series Transponder.

### COM - AlphaBus Communications

The COM LED indicates any data traffic being received by the DM3X through the COM (AlphaBus) port. This LED will also blink one to three times approximately every 10 seconds, which indicates communication exists between the DM3X and other connected devices, such as a generator or additional XM3.

### BAT A/B - Battery Strings A & B

The LED indicator remains ON solid when the battery string wiring harness is correctly connected to the batteries and the Bat A/B connector on the DM3X.

### BAT C/D - Battery Strings C & D

The LED indicator remains ON solid when the battery string wiring harness is correctly connected to the batteries and the Bat C/D connector on the DM3X.

## 9.0 Start Up and Verification, continued

### 9.3.2 Resetting the Transponder

Should the need arise to reset the transponder locally, such as in the case of adding additional power supplies, a generator, or carrying out maintenance activities, do the following:

Press and hold the reset button (RST) for approximately three (3) seconds until the ALM/RDY LED stops blinking and turns solid (green). Release the button. The transponder will perform its power up sequence.

### 9.4 Verifying Communications via the Headend

Using SNMP, check connectivity by verifying power supply data by doing the following:

- With a MIB browser, check power supply data in the psIdent MIB branch (1.3.6.1.4.1.5591.1) of the SCTE-HMS tree.
- With network management software, verify the DM3.0 Series Transponder has been identified and is reporting data correctly.

## 9.0 Start Up and Verification, continued

### 9.5 Dual IP Mode

#### 9.5.1 Overview

The DM3.0 Series Transponder can operate in either Single (default) or Dual IP mode. In Single IP mode, data from both the cable modem and power supply are accessed and managed through the modem's IP address on the secure private modem network. In Dual IP mode, the Communications Module acts like a CPE device to the cable modem and registers a second IP address on the public CPE network.

The following table lists some of the common characteristics of the DM3.0 Series Single IP and Dual IP configurations:

| Single IP Mode vs. Dual IP Mode |   |   |
|---------------------------------|---|---|
|                                 | Single IP   | Dual IP   |
| Network                         | All data from both the cable modem and power supply are accessed and managed through the modem's IP address on the secure private modem network.                                | The Communications Module acts like a CPE device to the cable modem and registers a second IP address on the public CPE network.  |
| Data Access                     | The Network Management System requires access to the same private modem network.  | Dual IP mode allows the power supply data to be accessed and managed from anywhere within the public (CPE) network.   |
| Security                        | Communication with the Communications Module is limited to the private LAN network, and is very secure.   | Since the Communications Module is a CPE on the public network, access may be less secure.  |
| IP Addresses                    | Where the IP address pool is limited, there is no need to issue the Communications Module a CPE IP address. Only one (1) IP Address is required for the cable modem of the DM3. | The CPE requires its own IP address, which may be in short supply. A total of two (2) IP addresses are required, one for the cable modem and one for the Communications Module. |
| Data Management                 | Access to the Communications Module is limited to the private LAN network making data management less versatile, especially for field personnel.                                | The Communications Module is accessible on the public (CPE) network. This makes data management more versatile for field personnel.   |

Table 9-3, Single IP Mode vs. Dual IP Mode

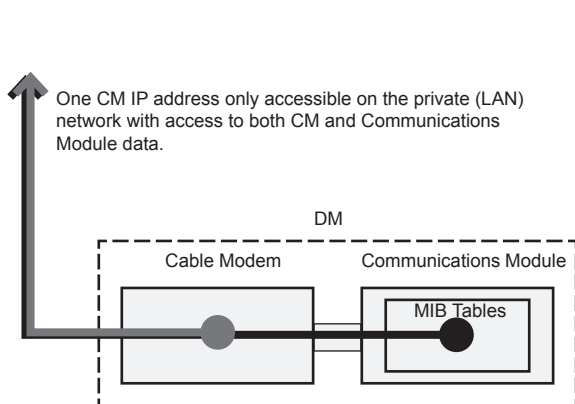

Fig. 9-6, Simplified Block Diagram Single IP Mode

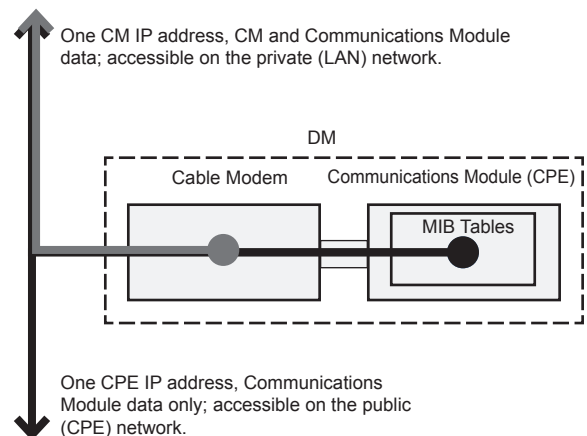

Fig. 9-7, Simplified Block Diagram Dual IP Mode

## 9.0 Start Up and Verification, continued

### 9.5.2 Web Comparison, Single IP Mode/Dual IP Mode

To easily determine the configuration of the Communications Module when viewing it on its Web page, check the Configuration line as well as the entries for the CM and CPE addresses. A single IP Communications Module will display a CM MAC address only, while a Dual IP Communications Module will also indicate a CPE address.

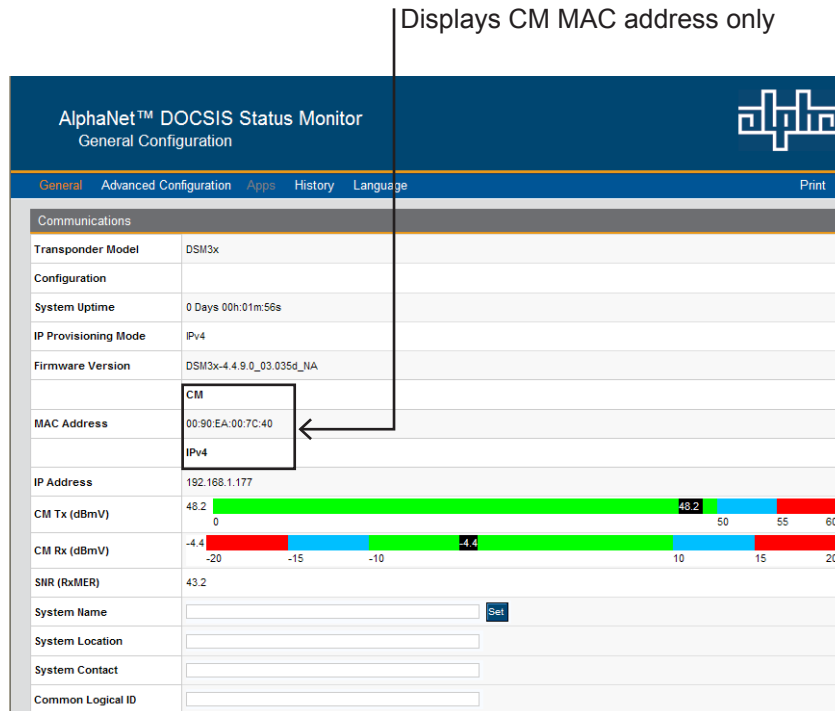

Fig. 9-8, Single IP DM3.0 Series Transponder Web Page

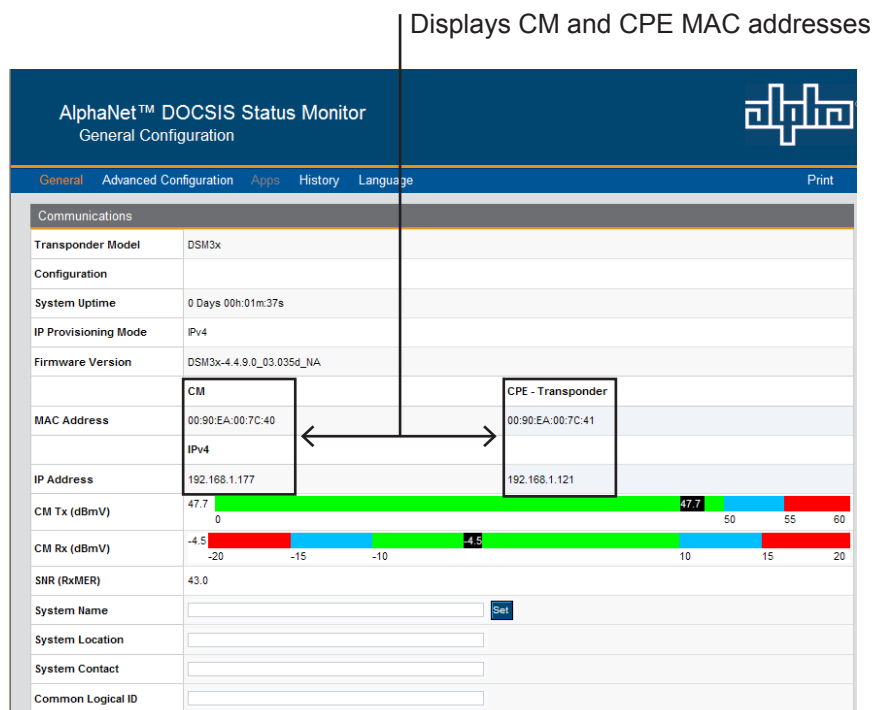

Fig. 9-9, Dual IP DM3.0 Series Transponder Web Page

## 9.0 Start Up and Verification, continued

### 9.5.3 Configuring Dual IP Mode

To switch the DM3.0 Series Transponder from Single to Dual IP mode the `atiMgmtSnmpSnmpCPEAccess` parameter of the Alpha MIB will need to be enabled. The Dual IP enable setting can be set through the DOCSIS Configuration File, the DM3.0 Setup File (`atidoc33.cfg`), the Provisioning Mode via the Communications Web page or remotely using SNMP by setting the following Alpha MIB:

| Enabling Dual IP Mode                 |                             |                                    |   |
|---------------------------------------|-----------------------------|------------------------------------|---|
| MIB Parameter                         | Object ID                   | Description                        | Value   |
| <code>atiMgmtSnmpSnmpCPEAccess</code> | 1.3.6.1.4.1.926.1.3.1.3.6.0 | Enables/Disables the CPE Interface | 1=Disabled (Single IP)<br>2=Enabled (Dual IP) |

**Table 9-4, Enabling Dual IP Mode**

The CPE Communications Module IP can be assigned its IP, Subnet Mask and Gateway Addresses either via DHCP (default) or manually, either through the web page or via the below SNMP settings:



**NOTICE:**

After configuring the Static settings the Communications Module must be reset in order for the settings to take effect.

| CPE Communications Module IP Settings             |                                 |  |                    |
|---|---------------------------------|--|--------------------|
| MIB Parameter                                     | Object ID                       | Description  | Value              |
| <code>atiMgmtSysMonitoringCpeStaticMode</code>    | 1.3.6.1.4.1.926.1.3.2.2.5.2.1.0 | Method by which the CPE acquires its IP address.                                     | 1=DHCP<br>2=Static |
| <code>atiMgmtSysMonitoringCpeStaticAddress</code> | 1.3.6.1.4.1.926.1.3.2.2.5.2.2.0 | When the IP address is static, this is the IP address to which the CPE will respond. | 0.0.0.0 (default)  |
| <code>atiMgmtSysMonitoringCpeStaticMask</code>    | 1.3.6.1.4.1.926.1.3.2.2.5.2.3.0 | When the CPE IP address is static, this is the subnet mask.                          | 0.0.0.0 (default)  |
| <code>atiMgmtSysMonitoringCpeStaticGateway</code> | 1.3.6.1.4.1.926.1.3.2.2.5.2.4.0 | When the IP address is static, this is the IP address of the gateway.                | 0.0.0.0 (default)  |

**Table 9-5, CPE Communications Module IP Settings**

## 9.0 Start Up and Verification, continued

To change the CPE IP address allocation option from DHCP to Static via the Web Server, refer to the following:

1. Connect to DM3.0 Series Transponder via Web browser per the procedure in Section 4.0, Web Interface.
2. In the Advanced Configuration menu of the Web page, click the Communications button.
3. Click the Static button in the CPE Communications Module column of the page. Refer to Figure 9-10. When prompted for User Name and Password, refer to Section 4.3.1, Web Interface Security Levels for User Name and Security Password.
4. Enter the desired IP Address, Subnet Mask and Gateway in the provided data fields.
5. Click the Set button to update the Communications Module with the new values.
6. Confirm the new Static IP Address is listed under the CPE Communications Module column of the General page. Refer to Figure 9-11.

The screenshot shows the 'AlphaNet™ DOCSIS Status Monitor' interface, specifically the 'General Configuration' page. The 'Communications' section is active, displaying various system parameters. Two boxes highlight the IP configuration for the 'CM' and 'CPE - Transponder'. The CM has an IP of 192.168.1.177, and the CPE - Transponder has an IP of 192.168.1.121. Below the IP fields are signal strength indicators for CM Tx (47.7 dBmV) and CM Rx (-4.5 dBmV), along with SNR (43.0). At the bottom, there are input fields for System Name, System Location, System Contact, and Common Logical ID, with a 'Set' button next to the System Name field.

Fig. 9-10, Dual IP Configuration Settings for Web Server Communications Page

The screenshot shows the 'AlphaNet™ DOCSIS Status Monitor' interface, specifically the 'Advanced Communication Configuration' page. The 'Network Provisioning' section is active. The 'Provisioning Mode' is set to 'Dual IP'. The 'DHCP/Static' section shows the 'Static' option selected. Two boxes highlight the IP configuration for the 'CM' and 'CPE - Transponder'. The CM has an IP of 192.168.1.177, and the CPE - Transponder has an IP of 192.168.1.121. Below the IP fields are input fields for Subnet Mask (255.255.255.0) and Gateway (192.168.1.1), with a 'Set' button next to the Gateway field. Other parameters include Transponder Model (DSM3x), Serial Number (007C40), Hardware Revision (2.0), and System Uptime (0 Days 00h:06m:43s).

Fig. 9-11, Dual IP Parameters for Web Server General Page



## 9.0 Start Up and Verification, continued

atidoc33.cfg in Dual IP Mode



### NOTICE:

Refer to **Section 3.3.5** for details on using the atidoc33.cfg file to propagate custom settings to field-deployed DM3 Series Communications Modules.

In Dual IP mode, the DM3.0 Series Transponder will first attempt to download the proprietary configuration file atidoc33.cfg through the CPE's interface from a TFTP server on the CPE network. In many networks, the TFTP server is blocked or disabled, so the DM3.0 Series Transponder also has provisions to download this file through the Cable Modem interface from the modem's provisioning server if necessary. The filename and TFTP server location may also be specified through special tags in the DHCP Offer, refer to the paragraph below "Specifying atidoc33.cfg Name and Location via DHCP Tags" for details. Similar to Single IP mode, any DM3.0 Series Transponder proprietary SNMP MIB setting may be placed in the modem's DOCSIS configuration file which would eliminate the need for atidoc33.cfg.

### Changing Default atido03.cfg Download Settings in Dual IP Mode

The following table explains the download options available for the atidoc33.cfg file in Dual IP mode. The 'Download Interface' indicates the network from which the DM3.0 Series Transponder will attempt to download atidoc33.cfg, either the CPE network or the more secure cable modem management network.

| Available Download Options  |   |                                   |              |                    |
|---|---|-----------------------------------|--------------|--------------------|
| Parameter   | Comments  | Value                             | Search Order | Download Interface |
| atiMgmtSysDownloadConfigAddress<br>OID 1.3.6.1.4.1.926.1.3.2.1.10.0 | Overrides Default Location  | 0.0.0.0<br>(Default)              | 1            | CPE                |
| DHCP Server IP  | Server or Relay Agent Address from DHCP lease (No Change Necessary) | As Set                            | 2            | CPE                |
| DHCP Option 54 Server IP  | Server or Relay Agent Address from DHCP lease                       | As Set                            | 3            | CPE                |
| DHCP Tags   | User-defined  | As Set                            | 4            | CPE                |
| docsDevServerConfigTftpAddress<br>1.3.6.1.2.1.69.1.4.11.0           | Automatically set in modem  | CM's<br>TFTP<br>Server<br>Address | 5            | CM                 |
| docsDevSwServerAddress<br>1.3.6.1.2.1.69.1.3.7.0                    | Set via DOCSIS configuration file                                   | As Set                            | 6            | CM                 |
| Software Upgrade Server   | Set via DOCSIS configuration file                                   | As Set                            | 7            | CM                 |

**Table 9-6, Available Download Options**

## 9.0 Start Up and Verification, continued

Specifying atidoc33.cfg name and location via DHCP Tags

In the User-defined area of the DHCP Tags, above option 192, the Communications Module will look for the following value:

Tag: [Insert Unique Tag Name, e.g. 'ati-tag']

Value: aticonfig

In the Tag value immediately following will be the value for the TFTP server to use:

Tag: [Insert Unique Tag Name, e.g. 'ati-ip']

Value: IP address of TFTP server (i.e. 192.168.1.51)

Immediately following will be the value for the config filename:

Tag: [Insert Unique Tag Name, e.g. 'ati-name']

Value: =atidoc33.cfg (an equal sign needs to be in front of the filename for the DHCP server to recognize this as a valid entry)

### 9.5.4 Dual IP SNMP Community Strings

The Communications Module community strings used for the CPE Communications Module in Dual IP mode can be configured by the operator. The default Communications Module read-only community string is AlphaGet. The default read-write community string is AlphaSet. These settings can be configured with the DOCSIS Configuration File, the DM3.0 Setup File (aitdoc33.cfg) or remotely using SNMP by including the parameters below:



#### **NOTICE:**

These community strings are only applicable for CPE access in Dual IP mode. CM access in both Single IP and Dual IP modes use standard DOCSIS community strings set through the modem configuration file's docsDevNmAccessTable. See **Sections 3.3.1 and 3.3.2.**

| Community Strings  |                             |                             |                                   |
|--------------------|-----------------------------|-----------------------------|-----------------------------------|
| MIB Parameter      | Object ID                   | Description                 | Value                             |
| atiMgmtSnmpCommGet | 1.3.6.1.4.1.926.1.3.1.4.1.0 | Read Community String       | AlphaGet (default)[desired value] |
| atiMgmtSnmpCommSet | 1.3.6.1.4.1.926.1.3.1.4.2.0 | Read-Write Community String | AlphaSet (default)[desired value] |

**Table 9-7, Community Strings**

## 9.0 Start Up and Verification, continued

### 9.5.6 Security in Dual IP Mode

In Dual IP mode, additional SNMP security to the DM3.0 Series Transponder proprietary MIBs is required since the Communications Module and power supply data is exposed on the CPE network, which may be more vulnerable to packet sniffing and community string deciphering than on the secure cable modem network.

There are two methods of providing SNMP Security in Dual IP mode: the Data Access Key (default), and the Secure Access List.

#### Method 1: Dual IP Security Using the Data Access Key

In Dual IP mode `atiMgmtSnmpAlphaSetAccess` is the only SNMP parameter within the Alpha proprietary MIB with SNMP write access on the CPE network by default. When this parameter is set to the value of the parameter `atiMgmtSnmpAlphaSetKey`, the data access key, SNMP read/write access is granted to all parameters in the Alpha MIB tree with read/write attributes. When this access is granted, the value of `atiMgmtSnmpCPESetEnabled` is automatically changed to "2" (enabled). After the operator is finished setting the SNMP variables, SNMP write access can be disabled by setting the `atiMgmtSnmpCPESetEnabled` to "1" or by setting `atiMgmtSnmpAlphaSetAccess` to any value other than the data access key or by performing a reset to the DM3.0 Series Transponder.

The data access key parameters can be changed from the default values through the DOCSIS Configuration File, the DM3.0 Setup File (`atidoc33.cfg`) or remotely using SNMP by including the following Alpha MIB parameters:

| Data Access Key Parameters             |                             |   |   |
|--|-----------------------------|---|---|
| MIB Parameter                          | Object ID                   | Description   | Value   |
| <code>atiMgmtSnmpAlphaSetAccess</code> | 1.3.6.1.4.1.926.1.3.1.3.3.0 | Set to Access Key   | Set to match the value of <code>atiMgmtSnmpAlphaSetKey</code> |
| <code>atiMgmtSnmpAlphaSetKey</code>    | 1.3.6.1.4.1.926.1.3.1.3.4.0 | Data Access Key (Dual IP)   | CIBSET (default)  |
| <code>atiMgmtSnmpCPESetEnabled</code>  | 1.3.6.1.4.1.926.1.3.1.3.5.0 | Corresponds to whether or not the action taken on <code>atiMgmtSnmpAlphaSetKey</code> was successful. Once enabled, writing 1 to this variable will disable CPE sets. | 1 = Disabled (False)<br>2 = Enabled (True)                    |

**Table 9-8, Data Access Key Parameters**

## 9.0 Start Up and Verification, continued

### Method 2: Dual IP Security Using the Secure Access List

The DM3.0 Series Transponder provides an alternative method of providing additional SNMP security in Dual IP by limiting access to the Communications Module's CPE address. The Secure Access List method limits remote SNMP access to four IP addresses. Only the IP addresses listed in the SNMP Access Table are able to read or write to the Alpha MIB parameters from the public (CPE) network. This method overrides the default Data Access Key method.

The IP address entries in the SNMP Access Table can be set through the DOCSIS Configuration File, the DM3.0 Setup File (atidoc33.cfg) or remotely using SNMP by including the following Alpha MIB parameters:

| <b>Data Access Key Parameters</b> |                               |                                |                   |
|-----------------------------------|-------------------------------|--------------------------------|-------------------|
| MIB Parameter                     | Object ID                     | Description                    | Value             |
| atiMgmtSnpAccessTable             | 1.3.6.1.4.1.926.1.3.1.2       | Table of SNMP Access Addresses | Object identifier |
| atiMgmtSnpAccessAddress.1         | 1.3.6.1.4.1.926.1.3.1.2.1.2.1 | SNMP access IP Address #1      | 0.0.0.0 (Default) |
| atiMgmtSnpAccessAddress.2         | 1.3.6.1.4.1.926.1.3.1.2.1.2.2 | SNMP access IP Address #2      | 0.0.0.0 (Default) |
| atiMgmtSnpAccessAddress.3         | 1.3.6.1.4.1.926.1.3.1.2.1.2.3 | SNMP access IP Address #3      | 0.0.0.0 (Default) |
| atiMgmtSnpAccessAddress.4         | 1.3.6.1.4.1.926.1.3.1.2.1.2.4 | SNMP access IP Address #4      | 0.0.0.0 (Default) |

**Table 9-9, Secure Access Table Parameters**

# 10.0 Specifications

|  | DSM3X   | DM3 |
|--|---|-----|
| Battery Monitoring (DM3X Only):                                  | Up to four strings of 36V batteries   | N/A |
| Power System Management:   | Up to five power supplies and an AlphaGen generator are managed from a single DM3X including coordinated battery charging, system test and aggregated alarms  | N/A |
| Management Protocol:   | Standard ANSI/SCTE-HMS MIBs support basic power supply monitoring. Advanced diagnostics with battery and power module analytics available via secure SNMP   |     |
| <b>Advanced Diagnostics</b>                                      |   |     |
| Intelligent Power Supply Interface:                              | Power supply user interface displays advanced diagnostics including: DOCSIS modem upstream and downstream RF levels, IP address assigned by network DHCP server, MAC address and firmware versions, individual battery voltages to verify correct wire harness installation |     |
| Battery State of Health (Requires AlphaAPPs option) (DM3X Only): | Power supply internal analytic diagnostics report when batteries should be serviced.<br>Battery String Runtime Remaining<br>Battery Life Remaining  |     |
| Network Tools  | QAM Constellation Diagram: Identify types of interference and distortion in downstream RF signal.<br>Microreflections Meter: Locate microreflections detected in Coax caused by physical impairments.   |     |
| Utility Status & Events  | AC Line Status<br>Utility Performance Status (outages, sags, surges, frequency)<br>Utility Events (24-hour and lifetime number of events)   |     |
| Power Inverter State of Health:                                  | Power supply internal diagnostics report if the power inverter requires service.<br>Reported Values: Inverter OK, Replace Inverter  |     |
| <b>Hardware</b>  |   |     |
| RF Cable Interface:  | F-connector, female, 75 Ohm, connector angle better accommodates coax bend radius when installed in some enclosures   |     |
| Local Interface:   | RJ-45, Ethernet, multi-mode operation   |     |
| LED Indicators:  | Ready/Alarm, Upstream registration, Downstream lock, AlphaBus activity, RF level, Link, CPE traffic, Battery Sense harness correctly connected  |     |
| I/O Control:   | 10-pin Molex: Digital input, Digital output, 5V, Common   |     |
| AlphaBus:  | RJ-11 offset tab: Multiple-power supply and AlphaGen communications   |     |
| Battery Monitoring (DM3X Only):                                  | 8-pin Molex battery string A/B and<br>8-pin Molex battery string C/D.   |     |
| Tamper:  | NO or NC, software configurable, reads enclosure door magnetic switch   |     |
| <b>Environment</b>   |   |     |
| Operating Temperature:   | -40 to 65°C / -40 to 149°F  |     |
| Storage Temperature:   | -40 to 85°C / -40 to 185°F  |     |
| Humidity:  | 10 to 90% non-condensing  |     |
| Regulatory Compliance:   | FCC Part 15 Class A<br>EN 50083-2:2006 EMC requirements for CATV equipment<br>EN 62040-2:2006 Uninterruptable power supply EMC requirements, Category C2<br>Surge: IEEE 587, Category B3<br>RoHS: Directive 2002/95/EC  |     |

\* Advanced diagnostics are available through Alpha Certified network monitoring systems.

| <b>Network Communications</b> |  |
|-------------------------------|--|
| DOCSIS (RF) Port Protocols:   | IP (docsDevNmAccess - IPv4, Coexistence - IPv6), UDP, TCP, DHCP, TFTP, SNMPv1,SNMPv2c, SNMPv3, HTTP, SNTP  |
| Ethernet Port:                | HTTP Web interface for local on-site diagnosis.  |
| MIBs:                         | Power supply (ANSI/SCTE 38-4)<br>Other SCTE-HMS MIBs as defined by the SCTE for power supply and generator status monitoring<br>Alpha proprietary advanced UPS diagnostics |

## 10.0 Specifications, continued

| DM3X  |  | DM3  |
|---|--|--|
| <b>Power Supply Monitored Parameters</b>          |  |  |
| Major Alarm:                                      | Aggregate alarm consisting of: Test fail, battery fail, line isolation alarm, output overload, inverter, over-temperature, N+1 active, fuse fail                             |  |
| Minor Alarm:                                      | Aggregate alarm consisting of: Temperature probe error, AC line loss, N+1 error  |  |
| Input Voltage:                                    | Reported from power supply V(in) measurement   |  |
| Output Voltage:                                   | Reported from power supply V(out) measurement  |  |
| Output Current:                                   | 0 to 25A standard on port 1<br>Port 2 requires power supply DOC option   |  |
| Output Power:                                     | Calculated; reported in AC Watts   |  |
| Input Current:                                    | Reported in Amps   |  |
| Input Power:                                      | Reported in Amps   |  |
| UPS Status:                                       | AC Line, Standby, Test in progress, Test alarm   |  |
| Charger Current:                                  | Reported in Amps   |  |
| Battery Discharge Current:                        | Reported in Amps   |  |
| Enclosure Door:                                   | Open or Closed   |  |
| Battery Voltage:                                  | Individual battery voltage, up to four strings of 3 batteries (maximum 12 batteries), ±100mV per battery.  |  |
| Battery Temperature:                              | Reported from power supply battery Remote Temperature Sensor (RTS)   |  |
| Remote Test Control:                              | Start/Stop power supply test cycle   |  |
| <b>Generator Monitored Parameters (DM3X Only)</b> |  |  |
| Status:   | Generator Off, Running, Alarm  |  |
| Generator Alarm:                                  | Aggregate alarm consisting of: Low oil pressure, engine over-temp, engine over-speed, crank limit, over voltage, low fuel, water intrusion, pad shear, gas hazard, test fail |  |
| Gas Hazard:                                       | OK, Alarm  |  |
| Water Intrusion:                                  | OK, Alarm  |  |
| Pad Shear:  | OK, Alarm  |  |
| Enclosure Door:                                   | OK, Alarm  |  |
| Ignition Battery Voltage:                         | Reported in DC volts, ±100mV   |  |
| Enclosure Temperature:                            | Reported in Celcius, ±2°C  |  |
| Low Fuel:   | OK, Alarm  |  |
| Remote Test Control:                              | Start / Stop generator test cycle  |  |
| <b>Cable Modem</b>                                |  |  |
| Compliance:                                       | DOCSIS 3.0   | EuroDOCSIS 3.0   |
| Transmit Frequency Range:                         | 5 to 42 MHz  | 5 to 65 Mhz  |
| Receive Center Frequency Range:                   | 91 to 857 MHz  | 112 to 858 Mhz   |
| Output Power Range:                               | TDMA:<br>+8 to +54 dBmV (32QAM, 64QAM)<br>+8 to +55 dBmV (8QAM, 16QAM)<br>+8 to +58 dBmV (QPSK)<br>S-CDMA:<br>+8 to +53 dBmV (All modulations of S-CDMA)                     | TDMA:<br>+68 to +114 dBuV (32QAM, 64QAM)<br>+68 to +115 dBuV (8QAM, 16QAM)<br>+68 to +118 dBuV (QPSK)<br>S-CDMA:<br>+68 to +113 dBuV (All modulations of S-CDMA) |
| Input Signal Range:                               | -15 to 15 dBmV   | 64QAM: 43 to 73 dBuV<br>256QAM: 47 to 77 dBuV  |
| Channel Bandwidth:                                | 6 MHz  | 8 Mhz  |
| <b>Additional Equipment</b>                       |  |  |
| 874-842-21 XP-BSC-3-6:                            | Wire Kit, Battery Sense, 1x36V, 6'   |  |
| 874-842-20 XP-BSC-6-6:                            | Wire Kit, Battery Sense, 2x36V, 6'   |  |
| Surge Arrestor<br>(Alpha p/n 162-028-10):         | Female/Female connector configuration, "F" type connector with integral ground block. Required for all installations   |  |

# 11.0 Glossary

## 11.1 Acronym Definitions

- ANSI: American National Standards Institute
- BER: Basic Encoding Rules [Bit Error Rate]
- CM: Cable Modem
- CMTS: Cable Modem Termination System
- CPE: Customer Premises Equipment
- DHCP: Dynamic Host Configuration Protocol
- DOCSIS: Data Over Cable Service Interface Specification
- EMS: Element Management System
- EVM: Error vector Magnitude
- HMS: Hybrid Management Sublayer
- IT: Information Technology
- MAC: Media Access Control
- MER: Modulation Error Ratio
- MIB: Management Information Base
- NMS: Network Management System
- QoS: Quality of Service
- RTS: Remote Temperature Sensor
- SCTE: Society of Cable Telecommunications Engineers
- SI: Serial Interface
- SNMP: Simple Network Management Protocol
- SNTP: Simple Network Time Protocol
- TFTP: Trivial File Transfer Protocol
- TOD: Time of Day
- UDP: User Datagram Protocol
- VoIP: Voice over Internet Protocol



---

Worldwide Corporate Offices

**North America**

Tel: +1 360 647 2360  
Fax: +1 360 671 4936

**Europe**

Tel: +49 9122 79889 0  
Fax: +49 9122 79889 21

**Latin America**

Tel: +561 792.9651  
Fax: +561 792.7157

**Asia Pacific**

Tel: +852 2736.8663  
Fax: +852 2199.7988