



| an EnerSys® company

CPH-48 Central Power Hub

(Formerly TE33-1820 RPN Enclosure)

User Guide ID: 0570203-J0

Effective: 04/2021



Read this manual carefully.

Learn how to protect your equipment from damage and fully understand its functions.

CPH-48

Central Power Hub



NOTE

For the latest version of software, firmware and product documentation, visit the Alpha website, alpha.ca



NOTE

Photographs contained in this manual are for illustrative purposes only. These photographs may not match your installation.



NOTE

Operator is cautioned to review the drawings and illustrations contained in this manual before proceeding. If there are questions regarding the safe operation of this powering system, contact Alpha Technologies or your nearest Alpha representative.



NOTE

Alpha shall not be held liable for any damage or injury involving its enclosures, power supplies, generators, batteries, or other hardware if used or operated in any manner or subject to any condition inconsistent with its intended purpose, or if installed or operated in an unapproved manner, or improperly maintained.

For technical support, contact Alpha Technologies:

Canada and USA: 1.888.462.7487

International: +1.604.436.5547

Email: support@alpha.ca

Copyright

Copyright © 2021 Alpha Technologies Ltd. All rights reserved. Alpha is a registered trademark of Alpha Technologies.

No part of this documentation shall be reproduced, stored in a retrieval system, translated, transcribed, or transmitted in any form or by any means manual, electric, electronic, electromechanical, chemical, optical, or otherwise without prior explicit written permission from Alpha Technologies.

This document, the software it describes, and the information and know-how they contain constitute the proprietary, confidential and valuable trade secret information of Alpha Technologies, and may not be used for any unauthorized purpose, or disclosed to others without the prior written permission of Alpha Technologies.

The material contained in this document is for information only and is subject to change without notice. While reasonable efforts have been made in the preparation of this document to assure its accuracy, Alpha Technologies assumes no liability resulting from errors or omissions in this document, or from the use of the information contained herein. Alpha Technologies reserves the right to make changes in the product design without reservation and without notification to its users.

Contents

1. Safety	4
1.1 Safety symbols.....	4
1.2 General warning and cautions	4
1.3 Mechanical safety	5
1.4 Electrical safety.....	5
2. Overview	6
3. Specifications	8
4. Features	9
4.1 Cordex HP 1.2kW rectifier system	9
4.2 Cordex HP LPS36 up-converter	10
4.3 Cordex CXCM1+ and CXCM1 HP controller	11
4.4 High voltage 50-pair protector panel.....	12
4.5 Internal AC load center	12
4.6 48Vdc heat exchanger	13
5. Inspection	14
5.1 Packing materials.....	14
5.2 Returns for service.....	14
5.3 Check for damage.....	14
5.4 General receipt of shipment.....	14
6. Installation	15
6.1 Safety precautions	15
6.2 Installation tools	15
6.3 Site selection.....	15
6.4 Installation and safety precautions.....	16
6.5 Pole mounting the enclosure	16
7. Wiring	17
7.1 Grounding the enclosure.....	17
7.2 AC power and OSP cable entry	20
7.3 Bonding OSP cable shield to the master ground bar	21

7.4	AC input wiring to the load center	23
7.5	DC output.....	23
8.	Maintenance	28
8.1	Heat exchanger fan test procedure.....	29
8.2	Heat exchanger fan replacement procedure.....	30
9.	Warranty statement and service information	32
9.1	Technical support	32
9.2	Warranty statement.....	32
9.3	Product warranty	32
9.4	Battery warranty	32
9.5	Warranty claims	32
9.6	Service information	32
10.	Acronyms and definitions	33
11.	Certification	34

1. Safety

Save these instructions

This manual contains important safety instructions that must be followed during the installation, servicing, and maintenance of the product. Keep it in a safe place. Review the drawings and illustrations contained in this manual before proceeding. If there are any questions regarding the safe installation or operation of this product, contact Alpha Technologies or the nearest Alpha representative.

1.1 Safety symbols

To reduce the risk of injury or death, and to ensure the continued safe operation of this product, the following symbols have been placed throughout this manual. Where these symbols appear, use extra care and attention.

The use of ATTENTION indicates specific regulatory/code requirements that may affect the placement of equipment and /or installation procedures.



NOTE

A **NOTE** provides additional information to help complete a specific task or procedure. Notes are designated with a checkmark, the word **NOTE**, and a rule beneath which the information appears



CAUTION!

CAUTION indicates safety information intended to **PREVENT DAMAGE** to material or equipment. Cautions are designated with a yellow warning triangle, the word **CAUTION**, and a rule beneath which the information appears.



WARNING!

WARNING presents safety information to **PREVENT INJURY OR DEATH** to personnel. Warnings are indicated by a shock hazard icon, the word **WARNING**, and a rule beneath which the information appears.



HOT!

The use of **HOT** presents safety information to **PREVENT BURNS** to the technician or user.

1.2 General warning and cautions



WARNING!

This system is designed to be installed in a restricted access location which is inaccessible to the general public

1.3 Mechanical safety

- Keep hands and tools clear of fans. Fans are thermostatically controlled and switch on automatically.
- Power supplies can reach extreme temperatures under load.
- Use caution around sheet metal components and sharp edges.

1.4 Electrical safety



WARNING!

Hazardous voltages are present at the input of power systems. The DC output from rectifiers, though not dangerous in voltage, has a high short-circuit current capacity that may cause severe burns and electrical arcing.

The DC output from converters is a potentially hazardous voltage. Do not touch the output connections when under power. Ensure that power has been removed from the outputs before working on them.

Before working with any live battery or power system, follow these precautions:

- a. Remove all metallic jewelry, such as watches, rings, metal rimmed glasses, or necklaces.
- b. Wear safety glasses with side shields at all times during the installation.
- c. Use insulated hand tools. Do not rest tools on top of batteries.



WARNING!

Lethal voltages are present within the power system. Always assume that an electrical connection or conductor is energized. Check the circuit with a voltmeter with respect to the grounded portion of the enclosure (both AC and DC) before performing any installation or removal procedure.

- Do not work alone under hazardous conditions.
- A licensed electrician is required to install permanently wired equipment. Input voltages can range up to 240Vac.
- Ensure that no liquids or wet clothes come into contact with internal components.
- The enclosure which contains the DC or AC power system along with customer installed radios must remain locked at all times, except when authorized service personnel are present.
- Always assume electrical connections or conductors are live. Turn off all circuit breakers and double-check with a voltmeter before performing installation or maintenance.
- At high ambient temperature conditions, the internal temperature can be hot so use caution when touching the equipment.

2. Overview

NOTE: The TE33-1820 is a central power hub enclosure which can provide up to forty-eight $\pm 190\text{VDC}$ line powering channels from an AC utility source. To better communicate the function and application of the system, marketing material (manual, datasheet, website) will refer to the TE33-1820 RPN enclosure as the CPH-48.

The CPH-48 is a NEMA 3R outdoor remote power node enclosure providing up to forty-eight $\pm 190\text{Vdc}$ line powering channels from an AC utility power source. The CPH-48 utilizes remote line powering equipment as a method of energizing remote devices using power delivered from a central source over copper cable.

The CPH-48 is configured as follows:

- Cordex HP 1.2kW Front Access Rectifier Shelf System rated for 100A capacity at 48Vdc
- Cordex HP LPS36 -48Vdc to $\pm 190\text{Vdc}$ Remote Line Power System (48 channels/circuits)
- Cordex CXCM1+ or CXCM1 HP Controller
- Cordex HP LPS36 Fan Tray
- Cordex HP LPS36 Baffle
- High-Voltage 50-pair Protector Panel (5-pin gas tube modules sold separately)
- Internally mounted AC load center with AC surge protection
- Thermal management system: 48Vdc Heat Exchanger
- Pole mount only

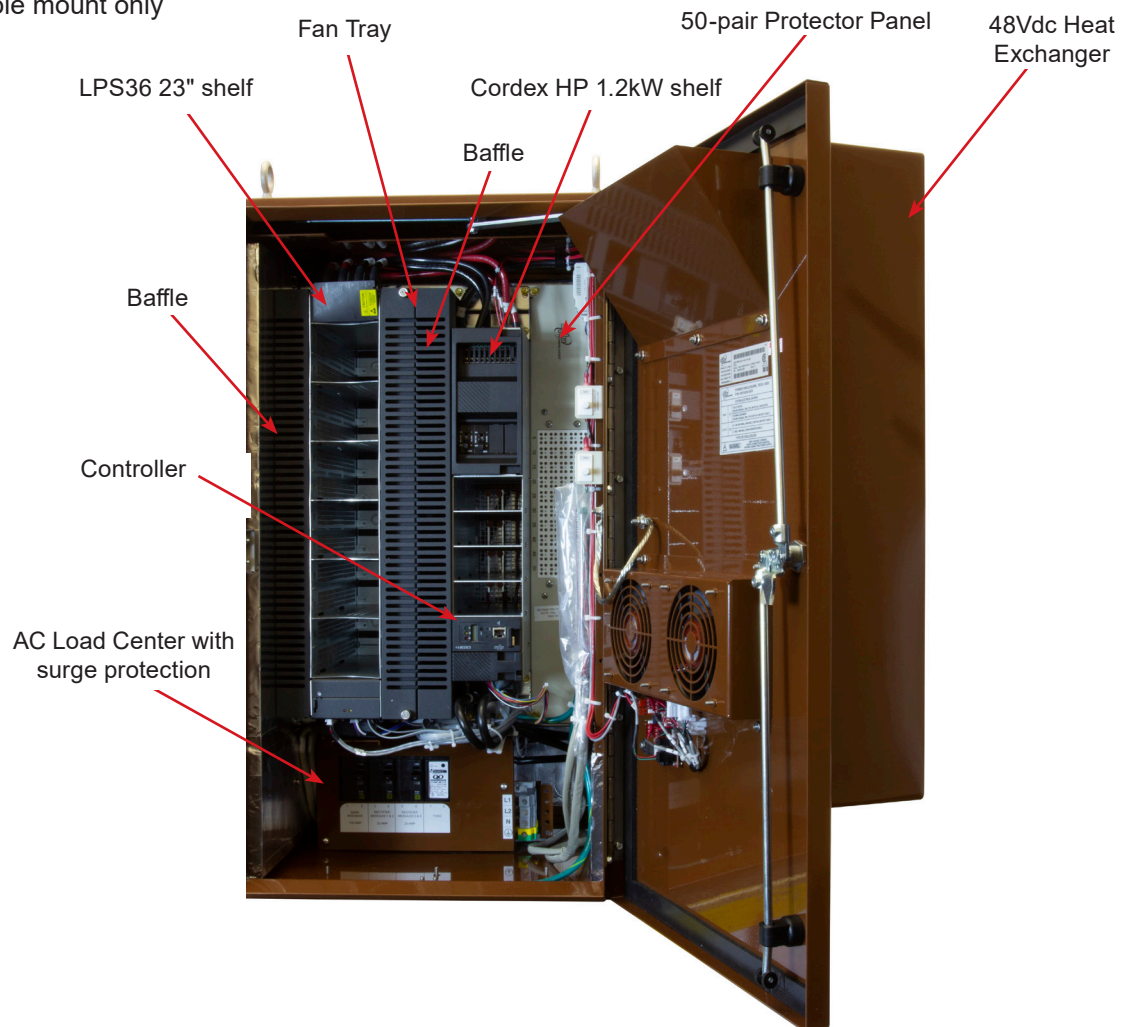

Figure 1 — CPH-48 interior view

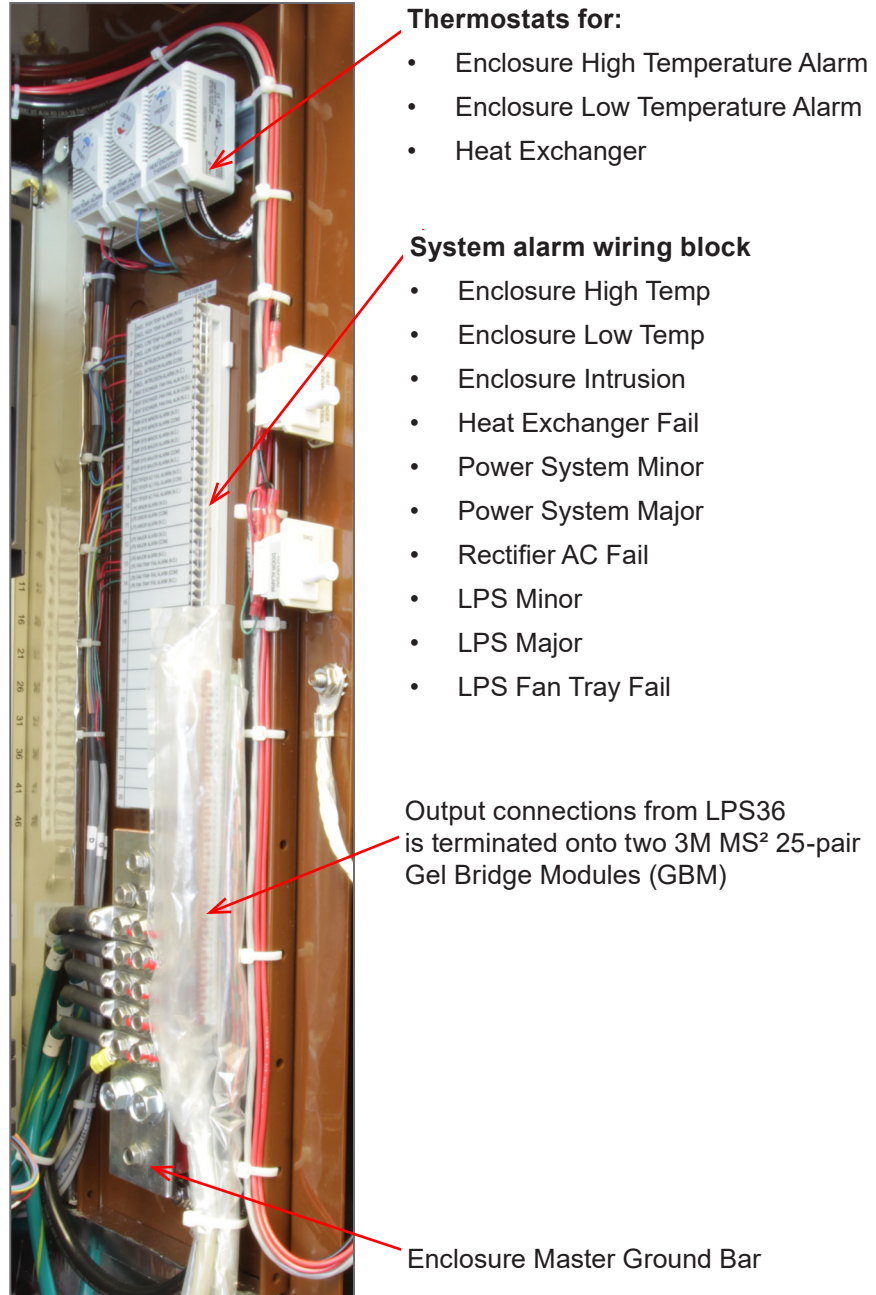

Figure 2 — CPH-48 enclosure equipment plate

3. Specifications

Electrical	
Input voltage	208-240Vac, 60Hz single phase (neutral is required)
Output voltage	48Vdc (CXRF 48-1.2kW rectifier shelf) ±190Vdc (LPS36 converter shelf)
Output power	4.8kW (4 x Cordex 48V rectifiers; Alpha #010-619-20) 4.8kW (12 x LPS36 48V to ±190V converters; Alpha #0120011-001)
Utility supply	208-240Vac, 30A Max, Single phase, 60 Hz, 3 wire + PE
Maximum input power	5.2kVA
Mechanical	
Dimensions (footprint)	838mm H x 455mm W x 508mm D (33" H x 17.9" W x 20" D)
Dimensions (enclosure)	838mm H x 455mm W x 658mm D (33" H x 17.9" W x 25.9" D)
Weight	75.3kg (166lb) all power modules installed
Mounting	Pole
Cooling	30 Watts/°C heat exchanger
Enclosure	Aluminum, 5052-H32
Environmental	
Operating temperature	-40 to +46°C (-40 to 115°F)
Storage temperature	-40 to +85°C (-40 to +185°F)
Humidity	0 to 95% non-condensing
Elevation	2000m (6,562ft)
Weather tightness	NEMA Type 3R
Acoustic noise	< 65 dBa
Agency compliance	
Enclosure ratings	CSA/UL Type 3R
Product safety	CSA/UL 60950-1-07 CSA/UL 60950-21 CSA/UL 60950-22

4. Features

4.1 Cordex HP 1.2kW rectifier system

For more information, refer to the [Cordex HP 1.2kW rectifier documentation](#).

Figure 3 shows the 1.2kW for AC to DC power conversion. The 48-1.2kW rectifier system is designed for front access to the following DC components:

- Controller shelf IO
- Cordex CXCM1+/CXCM1 HP series controller (field replaceable / hot swappable)
- Up to four hot-swappable 1.2kW rectifiers
- Four load circuit breakers
- 10-position GMT fuse block for 15A max. fuses

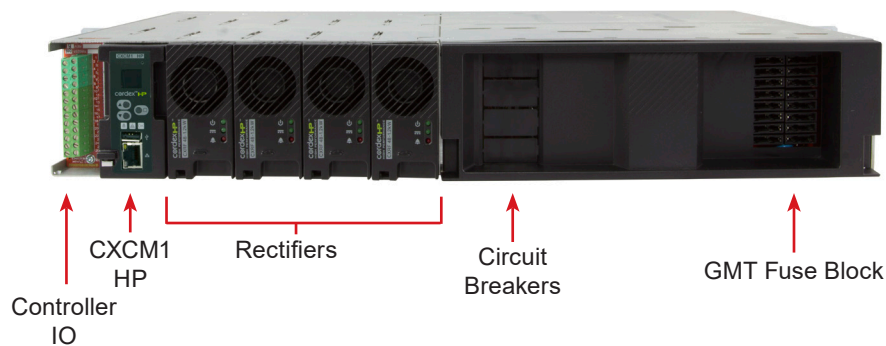

Figure 3 — Cordex 1.2kW shelf with CXCM1 HP series controller with distribution

Each fan-cooled 1.2kW rectifier provides 22.2A at 54Vdc, 25A maximum at 48Vdc (176 to 300Vac input).

A compact Cordex CXCM1 controller, which is integrated into the rectifier shelf, has LED indicator lights for status and alarms and a screen that displays voltage and current. The controller includes a web server interface that provides an easy set up via local or remote IP access using a standard Internet Explorer browser. (Refer to the communication settings chapter in the Cordex manual.)

Integrated logging captures data from multiple AC/DC voltages, load/battery currents, and cell voltages/temperatures. Common applications of the logging include power system details, thermal performance of outdoor enclosures, battery cell specifics, and mains variations captured by an AC voltage watchdog.

The shelf incorporates a distribution module for DC breaker/fuse output as well as battery connections. The module includes support for up to four AM plug-in breakers and ten GMT fuse positions. Two battery-landing positions, a 125A battery shunt, and a site ground are also provided.

4.2 Cordex HP LPS36 up-converter

For more information, refer to the [Cordex HP LPS36 converter documentation](#).

The LPS36 is a modular DC to DC up-converter system designed for distributed power communications applications using +/- 190Vdc over existing or new copper network.

Using switched mode technology, the LPS36 quad output converter module provides outstanding efficiency in a compact design. Applications include powering sealed DSLAM's, Distribution Point Units (DPU) as well as Optical Network Terminals (ONT) in Fiber to the Home Networks (FTTH). Each LPS36 converter module contains four isolated DC-DC converters, up to 96W nominal. Converter modules are ordered separately at time of ordering or later after the converter system has been installed. Blank plates can be ordered separately for empty slots.

- High efficiency >92% for increased operating expenses (OPEX) savings and reduced carbon footprint
- High temperature tolerance for installation in Central Office (CO) or harsh outside plant (OSP) cabinet environments
- Industry leading power density enabling up to 48 channels in a compact 2RU footprint
- High reliability convection-cooled design with optional fan tray
- Optional Cordex CXCM1 series of system controllers provide advanced remote web based monitoring and control features

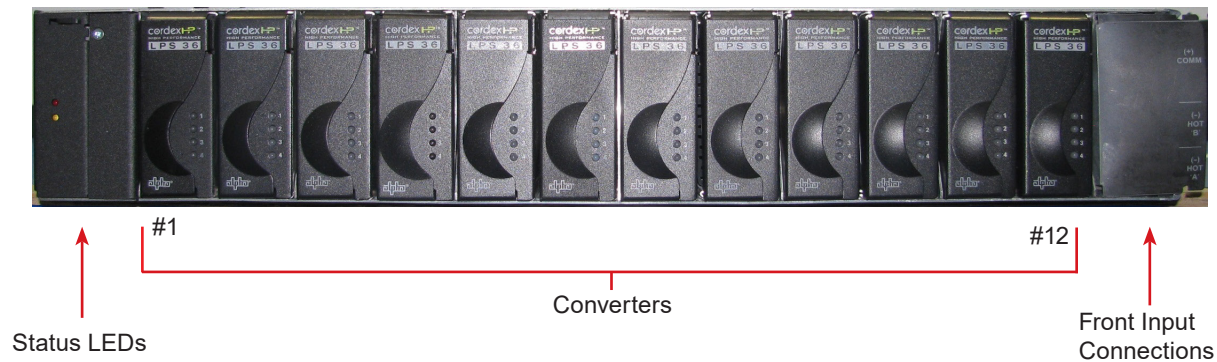

Figure 4 — LPS36 (23" shown)

4.3 Cordex CXCM1+ and CXCM1 HP controller

For more information, refer to the [Cordex CXCM1 HP controller documentation](#).

The Cordex controller is mounted in the rectifier system shelf bringing advanced monitoring technology to the rectifiers. This compact system controller is designed for seamless operation and set up of Alpha power systems, and is equipped with the complete range of software features, including the following:

- Designed to communicate directly with Cordex rectifiers
- Includes battery temperature compensation charging
- Battery performance diagnostics
- Provides local and remote communications
- User definable alarms
- Daily logging of power system events and system statistics

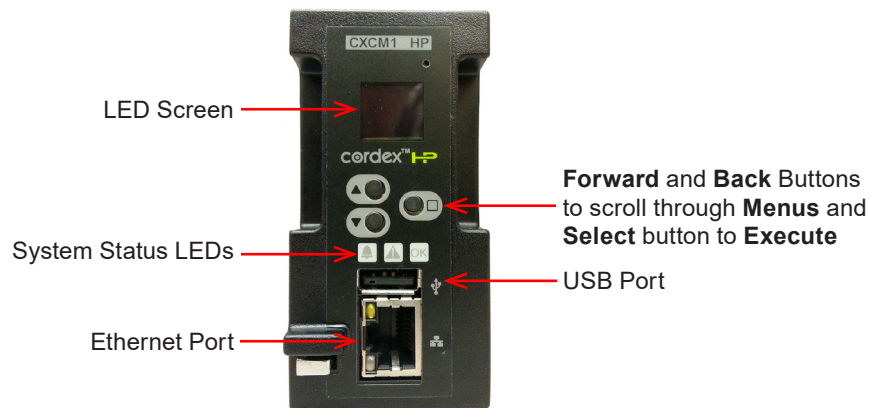
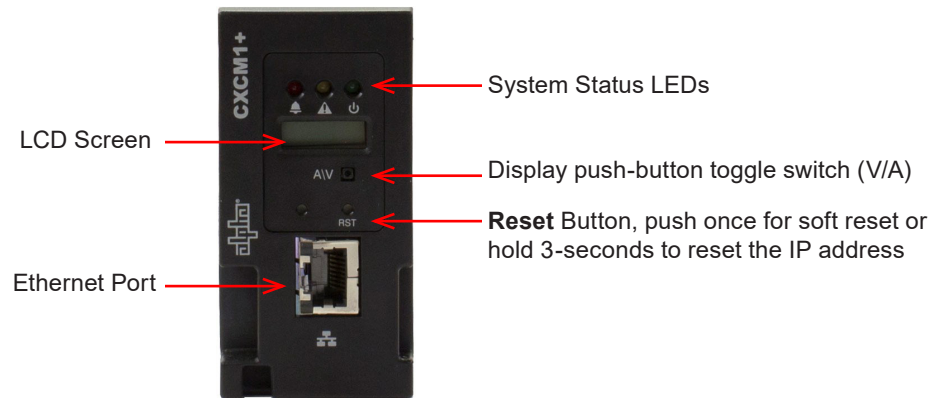

The Cordex controller includes a web server that provides easy set up and monitoring using an Internet connection with the standard web browser.

The data-logging feature allows the user to capture data from multiple inputs, for AC/DC voltages, load/battery current, cell voltages and temperatures (automatically for up to 16 user defined logs). Typical applications of the Cordex controller logging include power system details, thermal performance of outdoor enclosures, battery cell specifics, or mains variations captured by an AC voltage watchdog.

A built-in audio speaker sounds an intermittent tone during active alarms and the input/output (IO) board houses a series of terminal connections.

4.4 High voltage 50-pair protector panel

This panel provides overvoltage protection for up to 50 copper circuit pairs. The panel accepts 5-pin gas discharge tube (GDT) modules. Each loaded circuit requires one GDT module.

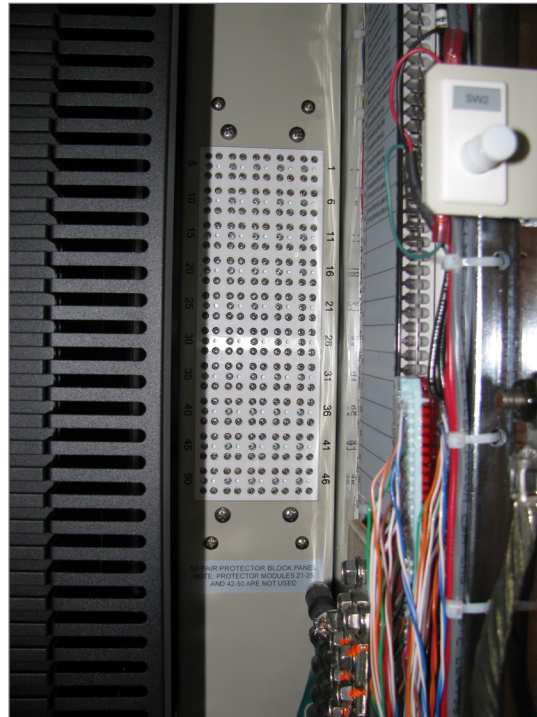

4.5 Internal AC load center

The CPH-48 enclosure includes an internal 208/240Vac load center that features easy access terminal blocks for AC mains connection, 100A main disconnect breaker and integrated surge suppressor.

Refer to the 0570203-05 drawing at the end of this manual for the load center wiring schematic.



4.6 48Vdc heat exchanger

The heat exchanger consists of a core, internal loop recirculation fans for cooling the enclosure interior, and fans in the shrouded front door that form the heat exchanger external loop.

The heat exchanger features adjustable thermostat control and a heat exchanger fan fail alarm output that is wired to the enclosure alarm block. Heat Exchanger fans shut off automatically when the enclosure door is opened.

Refer to the 0570203-05 drawing at the end of this manual for the heat exchanger wiring schematic.

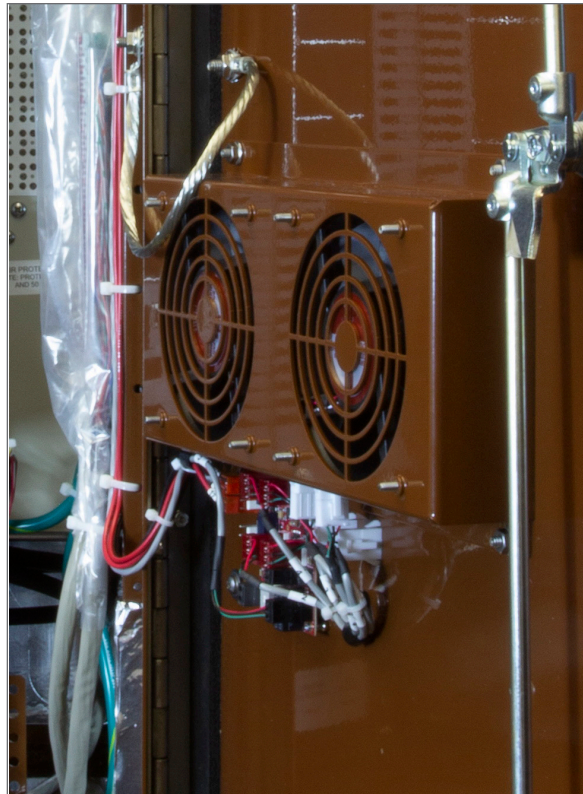







5. Inspection

5.1 Packing materials

Alpha Technologies is committed to providing products and services that meet our customers' needs and expectations in a sustainable manner, while complying with all relevant regulatory requirements. As such Alpha Technologies strives to follow our quality and environmental objectives from product supply and development through to the packaging for our products.

Rectifiers and batteries are shipped on individual pallets and are packaged according to the manufacturer's guidelines.

Almost all of Alpha's packaging material is from sustainable resources and or is recyclable. See the following table for the material and its environmental codes.

 PAP/PCB	 PET	 PE-LD	 PS	 FE	 ALU	 NW
Cardboard	Polyethylene Terephthalate	Low Density Polyethylene	Polystyrene	Steel	Aluminum	Wood

5.2 Returns for service

Save the original shipping container. If the product needs to be returned for service, it should be packaged in its original shipping container. If the original container is unavailable, make sure that the product is packed with at least three inches of shock-absorbing material to prevent shipping damage.

NOTE

Alpha Technologies is not responsible for damage caused by improper packaging of returned products.

5.3 Check for damage

Before unpacking the product, note any damage to the shipping container. Unpack the product and inspect the exterior for damage. If any damage is observed, contact the carrier immediately. Continue the inspection for any internal damage. In the unlikely event of internal damage, inform the carrier and contact Alpha Technologies for advice on the impact of any damage.

5.4 General receipt of shipment

The inventory included with your shipment depends on the options you have ordered. The options are clearly marked on the shipping container labels and bill of materials.

5.4.1 Rectifiers and converters (purchased separately)

Consult the packing slip to verify that you have received the correct number of rectifiers and converters per your order.

5.4.2 Miscellaneous small parts

Review the packing slip and bill of materials to determine the part number of the "configuration kits" included with your system. Review the bill of materials to verify that all the small parts are included. Call Alpha Technologies if you have any questions before you proceed: 1 888 462-7487.

6. Installation

Only qualified personnel should install and connect the power components within the Alpha power system. For the battery installation, refer primarily to the manufacturer's manual.

6.1 Safety precautions

Refer to the ["Safety"](#) section near the front of this manual.

6.2 Installation tools

Various insulated tools are essential for the installation. Use this list as a guide:

- Battery lifting apparatus (if required)
- Electric drill with hammer action, 1/2" capacity
- Various crimping tools and dies to match lugs used in installation
- Load bank of sufficient capacity to load largest rectifier to its current limit
- Digital voltmeter equipped with test leads
- Cable cutters
- MS2 splicing tool
- Cutters and wire strippers (#14 to #22 AWG) [2.5 to 0.34 mm²]
- Torque wrench: 1/4" drive, 0 - 150 in-lb.
- Torque wrench: 3/8" drive, 0 - 100 ft-lb.
- Insulating canvases as required (2' x 2', 1' x 1', 3' x 3')
- Various insulated hand tools including:
 - Combination wrenches.
 - Ratchet and socket set.
 - Various screwdrivers.
 - Electricians knife.
- Battery safety spill kit (required for wet cells only)

6.3 Site selection

Consider the following before selecting a mounting site:

- The Alpha CPH-48 enclosure is designed for pole mounting only.
- Avoid areas that may be subjected to hot air exhaust from nearby equipment or buildings.
- Avoid mounting in areas of extreme heat such as exposure to direct sunlight.
- Find out if your intended area is subjected to architectural controls or environmental restrictions.
- Do not install cabinet on poles equipped with power utility surge/lightening arresters, capacitor banks or power utility switching equipment.
- Contact local power Utility to determine whether power distribution system is Multi Grounded Neutral or Delta. Ensure that copper cable plant is properly bonded and grounded.
- Do not bond any equipment, strand or cable shields to power company surge/lightening arrester downleads in Delta power distribution areas.
- Cabinet locations will require periodic visits by craft personnel equipped with aerial lift vehicles. Choose cabinet pole locations that will not create traffic hazards.

6.4 Installation and safety precautions

Only qualified personnel should install and connect the power components within the Alpha power system. Refer to the ["Safety"](#) section.

6.5 Pole mounting the enclosure

The CPH-48 enclosure is designed for pole mounting only. Alpha offers a versatile wood pole mounting bracket solution (Alpha part number 0370452). The bracket allows the enclosure to be mounted flush with the pole. Refer to Figure 7 for pole mount bracket information.

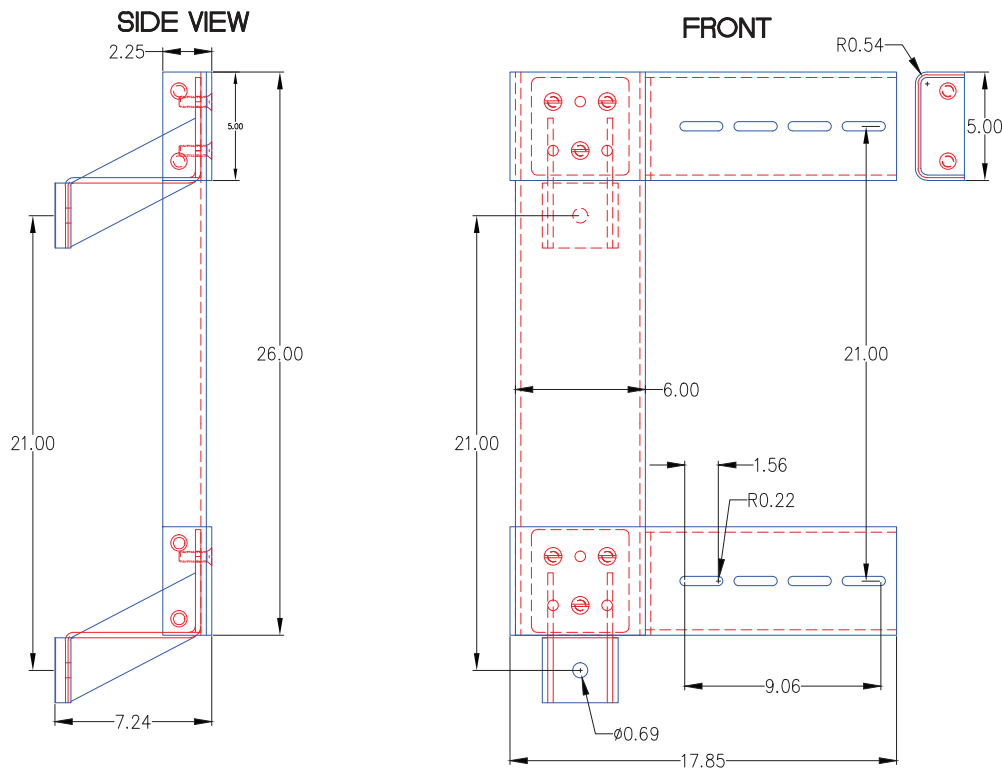

Figure 5 — Pole mount bracket detail

Use 3/8"-16 stainless steel hardware to mount the enclosure to the bracket after the bracket has been installed on the pole.

7. Wiring

Only qualified personnel should install and connect the power components within the Alpha power system.

7.1 Grounding the enclosure



WARNING!

An enclosure that is not properly grounded presents an electrical hazard and may result in premature equipment failure.

A proper grounding system that meets or exceeds the specifications of the equipment must be designed and installed prior to or in conjunction with the installation. The ground system must be bonded to the enclosure master ground bar to ensure a “common” or “single-point” ground. The following steps describe the installation of a recommended site grounding system for the CPH-48 Line Power cabinet. Actual ground system design must adhere to all local and national codes.

1. Install a **continuous** length of 6 AWG tinned solid copper ground wire (grounding electrode conductor) connecting the two driven ground rods and terminate it on the ACEG bus in the AC service disconnect enclosure. This length of conductor serves as a Vertical Ground Riser (VGR) (refer to [Figure 7](#)).



NOTE

It is recommended that all buried grounding connectors are 12" below finished grade line or below the frost line. For below grade connections, crimp or mechanical connectors may be used instead of an exothermic weld provided they are listed for direct burial applications.

2. Route a length of 6 AWG tinned solid copper conductor from a junction point with the VGR at a location below the cabinet to the Enclosure MGB, located on the right-side wall (refer to [Figure 7](#)).
3. Connect the length of conductor to the VGR via an irreversible compression connector or exothermic weld and connect the other end to the Enclosure MGB using a suitable two-hole compression lug. The enclosure MGB accepts a two-hole lug with 3/8" holes on 1" centers (refer to [Figure 6](#)).



NOTE

Avoid tight radius bends and route the conductor such that it intersects with the VGR in a downward manner as illustrated in [Figure 7](#).

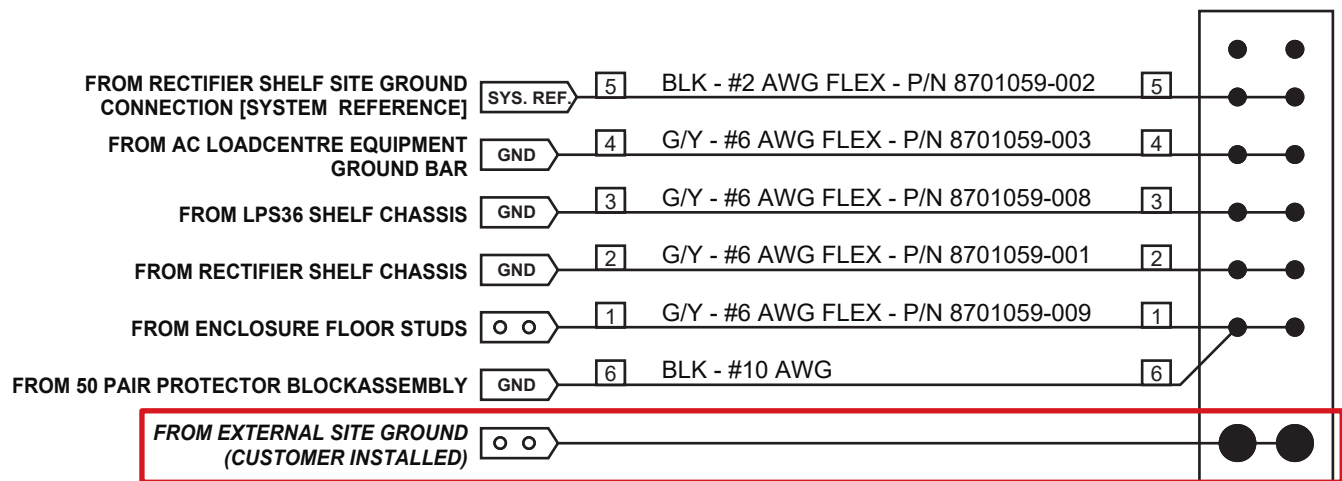

Figure 6 — CPH-48 enclosure master ground bar wiring

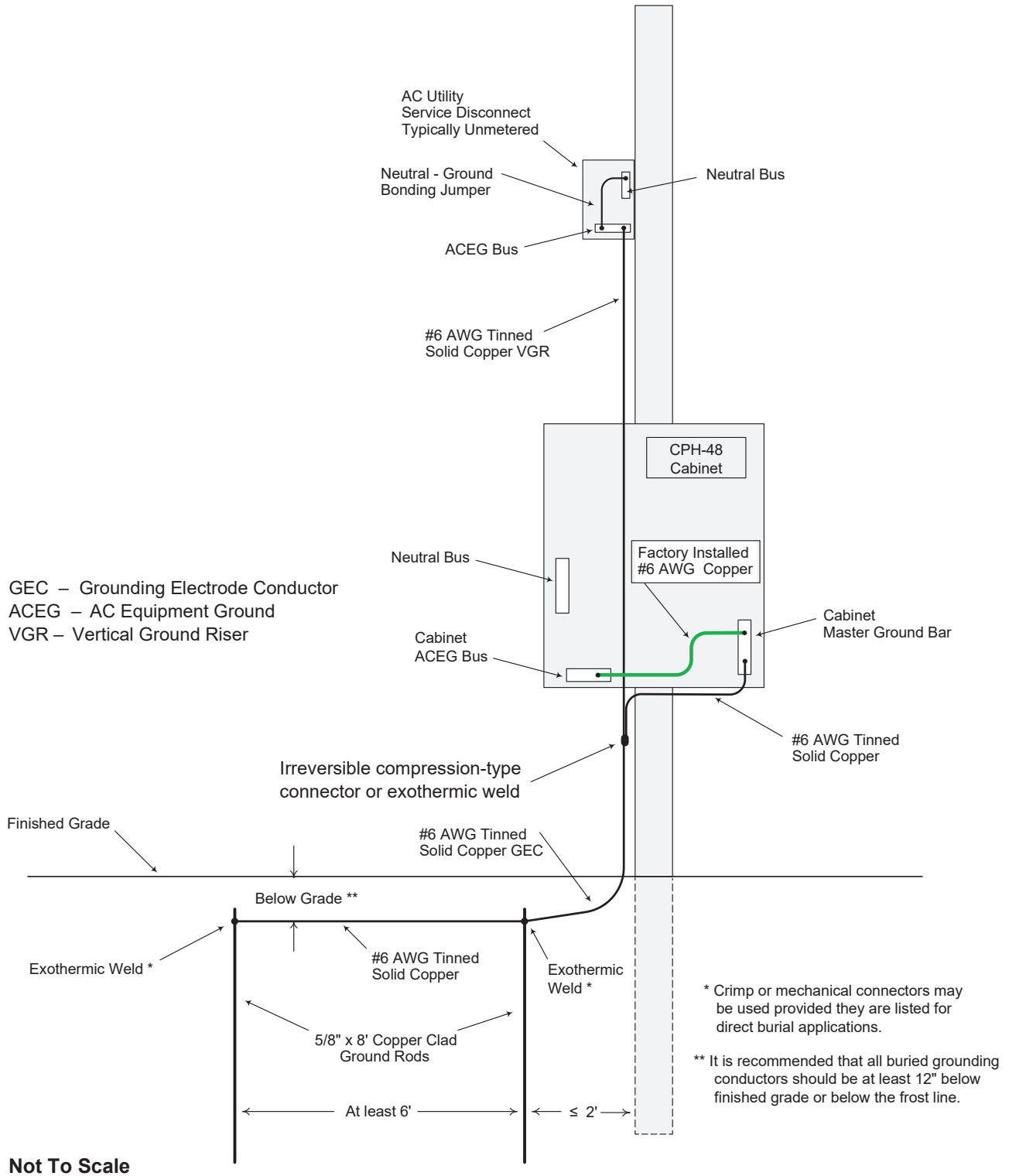

Figure 7 — Recommended CPH-48 cabinet grounding system

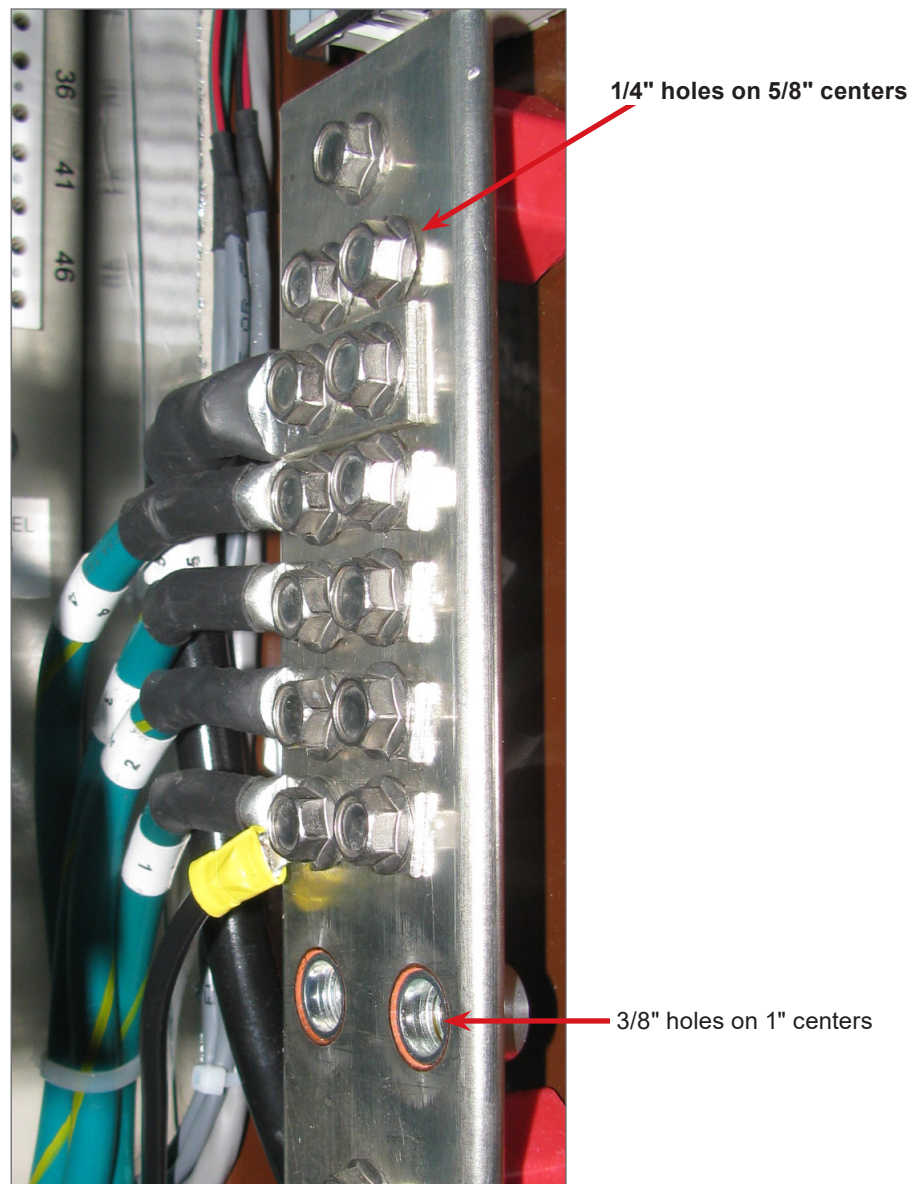

Figure 8 — Enclosure MGB and site ground

7.2 AC power and OSP cable entry

There are two knockouts located at the rear of the enclosure.

1. Use the 1 inch trade size knockout for AC power and ground connections.
2. Use the 2 inch trade size knockout for the OSP twisted pair cables.
3. Route the cables into the enclosure using appropriate conduit and fittings.
4. Use an appropriate fitting to create a seal around the cables to prevent ingress of dust, humidity, and insects.

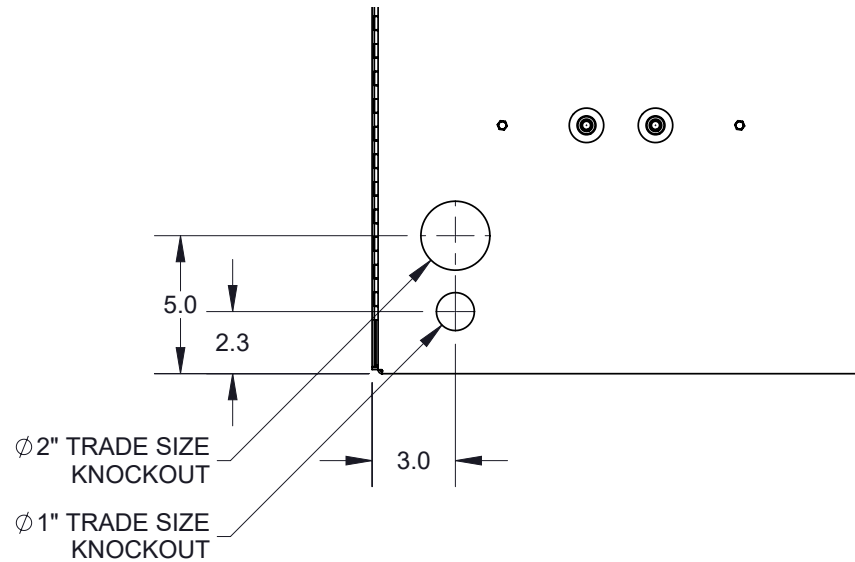

Figure 9 — Enclosure rear knockout

Alternatively, use an appropriately sized hole punch to make entry ports in the floor pan of the cabinet and use appropriate fittings to create a seal around the cables. Locate punched holes such that they do not create interference issues with equipment installed within the enclosure.

A Roxtec M63 Gland kit or similar product would be a good choice for a fitting that provides a high integrity seal for AC power and OSP twisted pair cable entry.

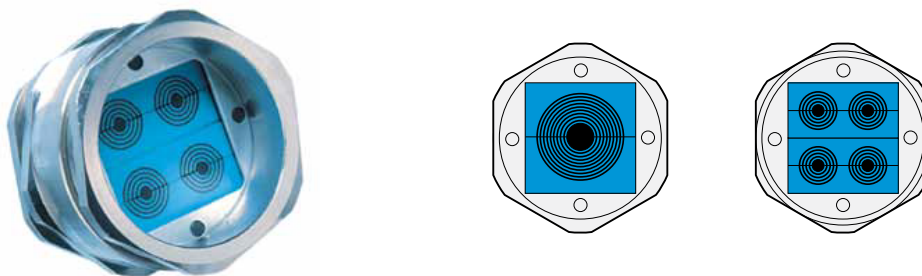

Figure 10 — M63 gland kit

7.3 Bonding OSP cable shield to the master ground bar

The OSP cable shield must be bonded to the Master Ground Bar (MGB). The OSP cable is the 50/100-pair twisted pair cable that carries the line power circuits out to the remote nodes. Shield bonding must take place at the cabinet and at all cable splice locations including the splice at the down converter location. High voltage surges such as lightning events could easily cause a flashover arc situation in the cabinet if the shield is not properly grounded.

Parts required

- Corning 80611384522 – 4460-DS-SS Shield Bond Connector

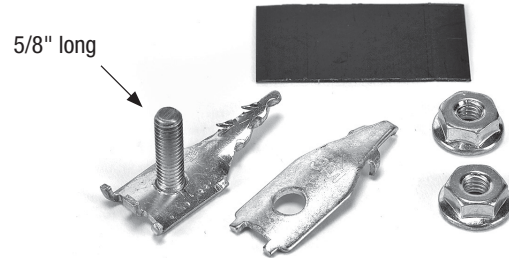

- Corning 80610096150 – 25T W/EYELETS 6IN (1/2x25') BOND BRAID (Optional) or,
- 6 AWG Grounding Conductor

Tools required

- 3/8" Terminal Wrench
- Tabbing Shears

7.3.1 Bonding procedure

1. For both single and double sheath cables, cut the shield flush with the sheath.

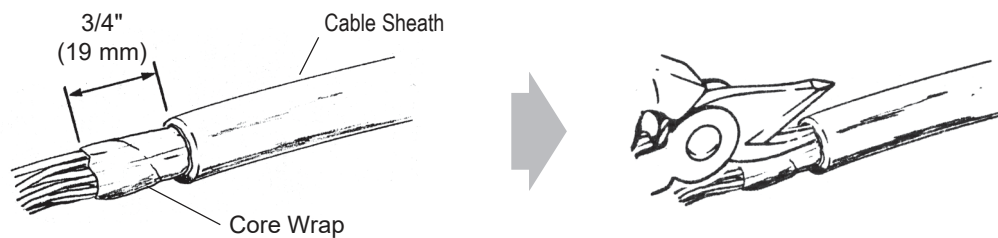

2. Take the OSP cable and insert the pair saving insulating shoe between the core wrap and the shield.

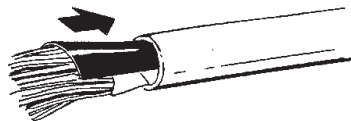

3. Insert the connector base between the shield and core wrap, or inner sheath for double sheath cables, until

the connector stops to meet the outer sheath. Tap the sheath above the connector base.

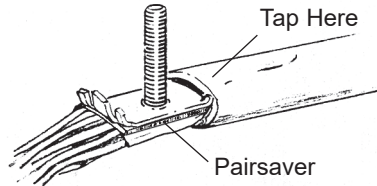

- If using an **exposed strand ground wire**, prepare the ground wire using 6 AWG stranded conductor. Place the exposed strand onto the lip of the connector base. Ensure the wire is long enough to reach the MGB without straining the cable or making any sharp bends. Fasten in place using supplied hardware.

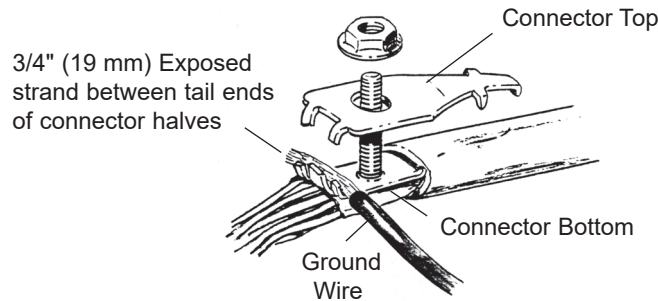

- If using a **pre-terminated ground wire**, place the lug from the wire directly onto the PEM. Fasten in place using supplied hardware.

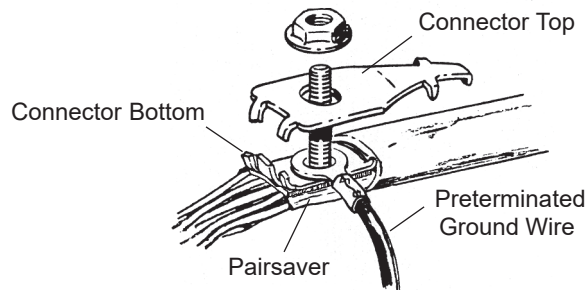

- Connect the other end of the ground wire to the enclosure MGB using a two hole compression lug. The enclosure MGB uses 1/4" holes on 5/8" centers.

NOTE: If there are already connections on the top position of the MGB, it will be necessary to remove the existing connections, land the OSP cable shield two-hole compression lug and re-connect the existing ground cables on top.

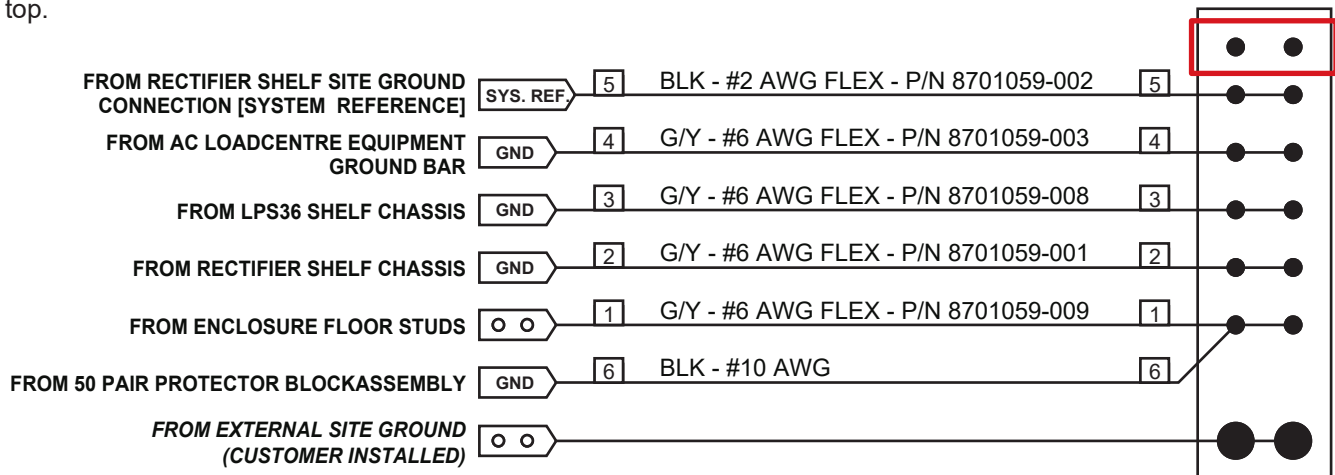

7.4 AC input wiring to the load center

Use the one inch knockout located at the rear of the enclosure behind the AC input terminal block to route the AC cable into the enclosure. Use appropriate conduit and fittings.

Make the connections in the table below to the AC Input block. Tighten to 25 in-lb.

Wire Color	Connection Terminal
BLACK - Line 1	L1
RED - Line 2	L2
WHITE - Neutral	N
GREEN - Ground	Protective Earth

Use cable ties to secure the wires to the terminal block cable tie bracket.

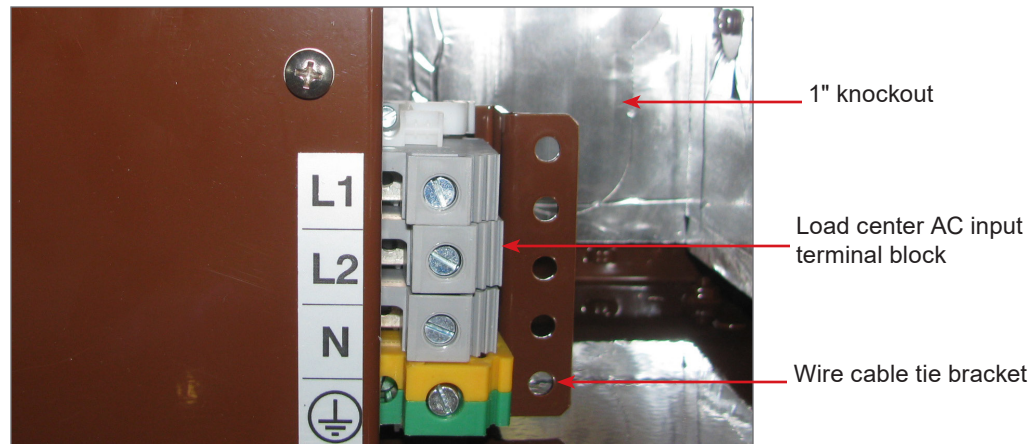

Figure 11 — Internal AC load center utility connection

7.5 DC output

The LPS36 shelf can accommodate up to 12 four-channel LPS36 converter modules providing up to a total of 48 ± 190Vdc output circuits. These circuits are accessed through two 25 pair cables terminated with 3M MS² 4005 Gel Bridge Module (GBM) connectors labelled MS2-1 and MS2-2. There are 24 output circuits available on each of these connectors. Refer to Figure 12 for GBM pinout and Figure 13 for GBM connector circuit assignments.

NOTE: Circuit #25 on connector MS2-1 and circuit #50 on connector MS2-2 are not used.

Use 25 or 50 pair load cables terminated with mating GBM connectors to interface to the system output GBM connectors. Route the load cables through the enclosure rear two inch knockout into appropriate conduit to the loads.

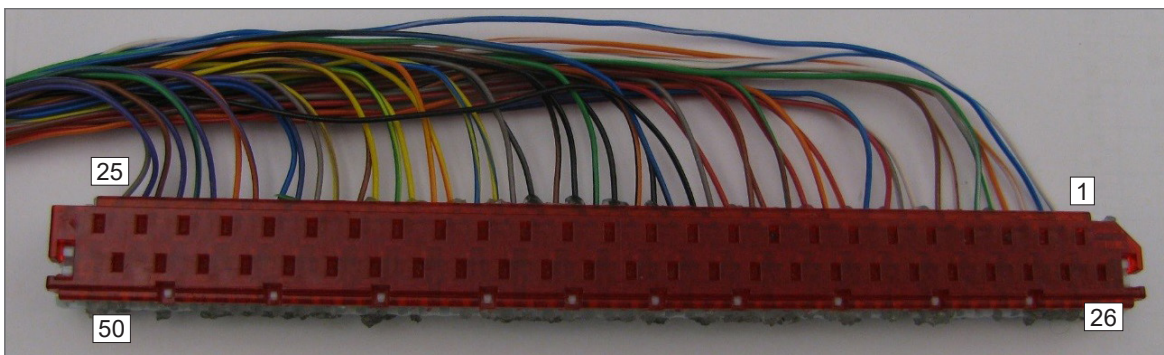

Figure 12 — DC GBM connector pinout

Table A — MS2-1 and MS2-2 connector circuit designations

Circuit	Tip wire color	MS2 pin	Tip polarity
	Ring wire color		Ring polarity
1	White/Blue	26	-190 Vdc
	Blue/White	1	+190 Vdc
2	White/Orange	27	-190 Vdc
	Orange/White	2	+190 Vdc
3	White/Green	28	-190 Vdc
	Green/White	3	+190 Vdc
4	White/Brown	29	-190 Vdc
	Brown/White	4	+190 Vdc
5	White/Gray	30	-190 Vdc
	Gray/White	5	+190 Vdc
6	Red/Blue	31	-190 Vdc
	Blue/Red	6	+190 Vdc
7	Red/Orange	32	-190 Vdc
	Orange/Red	7	+190 Vdc
8	Red/Green	33	-190 Vdc
	Green/Red	8	+190 Vdc
9	Red/Brown	34	-190 Vdc
	Brown/Red	9	+190 Vdc
10	Red/Gray	35	-190 Vdc
	Gray/Red	10	+190 Vdc
11	Black/Blue	36	-190 Vdc
	Blue/Black	11	+190 Vdc
12	Black/Orange	37	-190 Vdc
	Orange/Black	12	+190 Vdc
13	Black/Green	38	-190 Vdc
	Green/Black	13	+190 Vdc
14	Black/Brown	39	-190 Vdc
	Brown/Black	14	+190 Vdc
15	Black/Gray	40	-190 Vdc
	Gray/Black	15	+190 Vdc
16	Yellow/Blue	41	-190 Vdc
	Blue/Yellow	16	+190 Vdc
17	Yellow/Orange	42	-190 Vdc
	Orange/Yellow	17	+190 Vdc
18	Yellow/Green	43	-190 Vdc
	Green/Yellow	18	+190 Vdc
19	Yellow/Brown	44	-190 Vdc
	Brown/Yellow	19	+190 Vdc
20	Yellow/Gray	45	-190 Vdc
	Gray/Yellow	20	+190 Vdc
21	Violet/Blue	46	-190 Vdc
	Blue/Violet	21	+190 Vdc
22	Violet/Orange	47	-190 Vdc
	Orange/Violet	22	+190 Vdc
23	Violet/Green	48	-190 Vdc
	Green/Violet	23	+190 Vdc
24	Violet/Brown	49	-190 Vdc
	Brown/Violet	24	+190 Vdc
25	Violet/Gray	50	
	Gray/Violet	25	

Populate the 50-pair protector panel with the quantity of 5-pin gas tube modules corresponding to the number of loaded circuits. Install the gas tube modules in the protector panel numbered locations in accordance with shelf slots used (refer to diagram below).

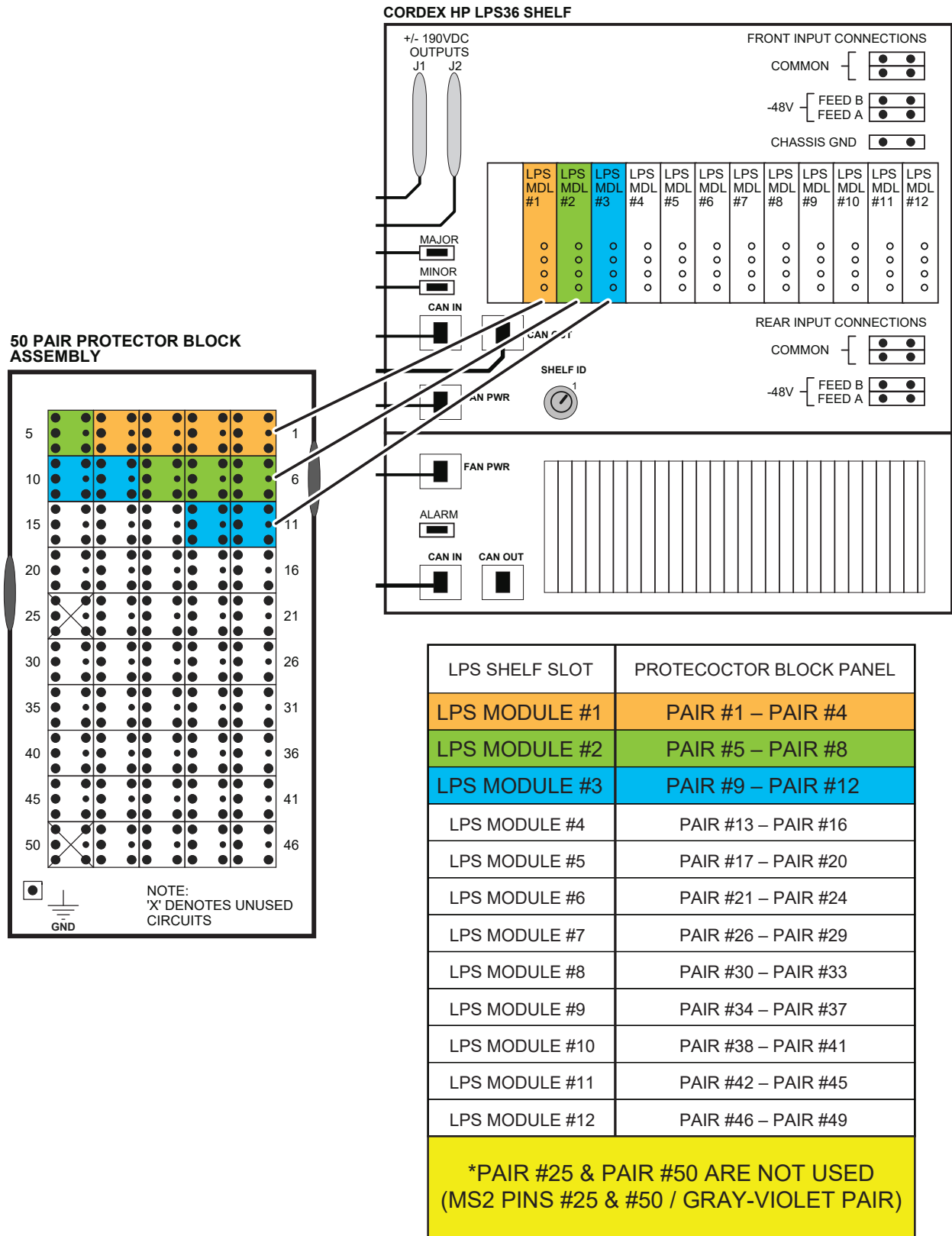

Figure 13 — CPH-48 line power cabinet channel mapping

7.5.1 Power enclosure alarm wiring block

The alarm wiring block, located on the right side wall in the enclosure, uses a Telco style '66' punchdown block. Refer to the schematic drawing, (0570203-05, page 3) at the end of this manual for the alarm schedule.

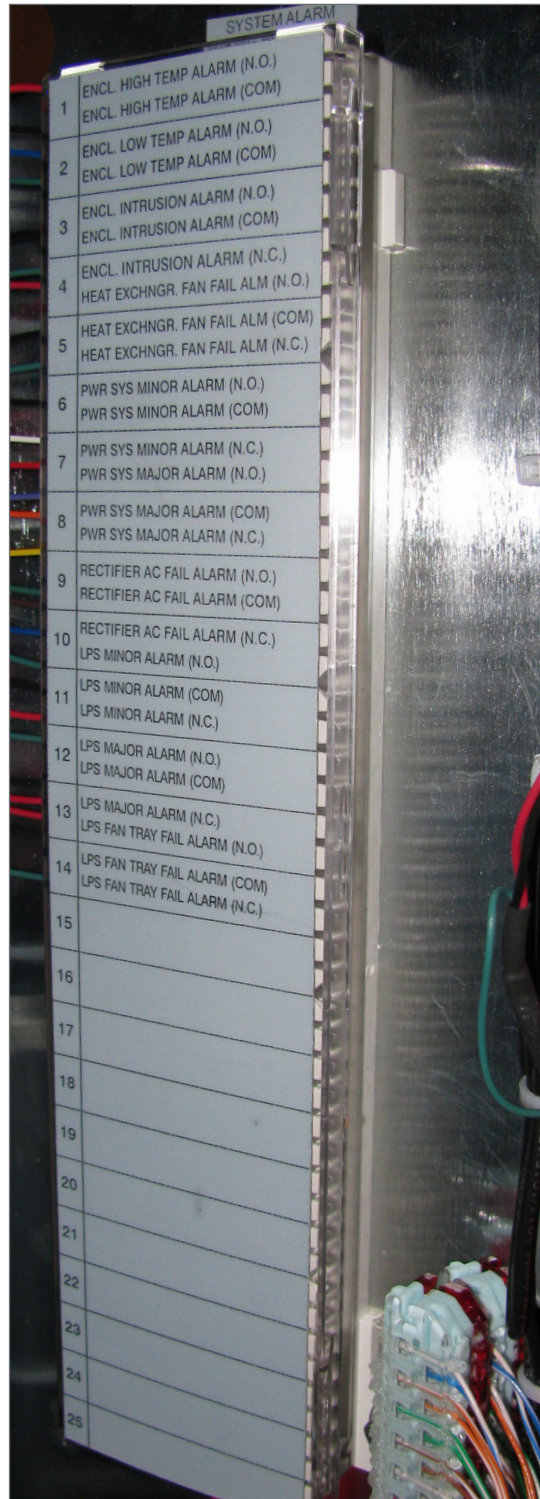

Figure 14 — Enclosure alarm block wiring

7.5.2 System startup

1. Ensure all AC breakers in the AC load center and all DC breakers in the rectifier shelf distribution are switched OFF.
Using Megger test or similar, make sure grounding points are within specification.
2. Install one rectifier module into the rectifier slot #1 and one LPS36 converter module into LPS36 shelf slot #1.
3. Verify AC input voltage is correct and switch the AC Main circuit breaker ON.



Rectifier and converter modules installed in slot #1 of respective shelves.

4. Switch the rectifier shelf feeder breaker corresponding to Modules #1 & #2 ON.
5. The rectifier module OK LED should illuminate after a preset delay.
6. Switch the left most DC breaker in the rectifier shelf distribution ON.
7. The LPS36 module LEDs should illuminate and flash on and off for a short period before turning solid green.
8. Verify loads are connected on circuits #1 - #4.

NOTE

Pairs will be energized once gas tubes are in place.

9. Install gas tube modules into protector panel positions for circuits #1 - #4.
10. Verify loads connected on circuits #1 - #4 are now receiving power.
11. Plug in remaining rectifier and LPS36 modules and switch remaining AC / DC breakers ON.
12. Install required number of gas tube modules in the protector panel. Verify they are installed in the correct locations in the panel (refer to section [7.5](#)).
13. Verify all connected loads are powered.
14. Install LPS36 module blanks in unused LPS shelf slots to ensure proper fan tray operation. Repeat this step for rectifier blanks.

Software

1. Refer to respective controller software manual to log in to controller.
2. Use the controller to test functionality of various module alarms and controls.

8. Maintenance

Although very little maintenance is required with Alpha systems, routine checks and adjustments are recommended to ensure optimum system performance. Qualified service personnel should do the repairs.

The following table lists a few maintenance procedures for this system. These procedures should be performed at least once a year.



WARNING!

Use extreme care when working inside the unit while the system is energized. Do not make contact with live components or parts.

Circuit cards, including RAM chips, can be damaged by static electricity. Always wear a grounded wrist strap when handling or installing circuit cards.

Ensure redundant modules or batteries are used to eliminate the threat of service interruptions while performing maintenance on the system's alarms and control settings.

Table B — Sample maintenance log

Procedure	Date completed
Test enclosure environmental and power system alarms (refer to schematic drawing for alarm block schedule).	
Check for firmware/software updates for the controller and power modules.	
Clean ventilation openings.	
Inspect all system connections.	
Verify heat exchanger for fan operation	

8.1 Heat exchanger fan test procedure

There are four heat exchanger fans. Two inner loop fans are located on the inside of the door and two outer loop fans on the outside of the door. Perform the following procedure to test the fans.

1. Pull out the plunger of the heat exchanger power door switch.

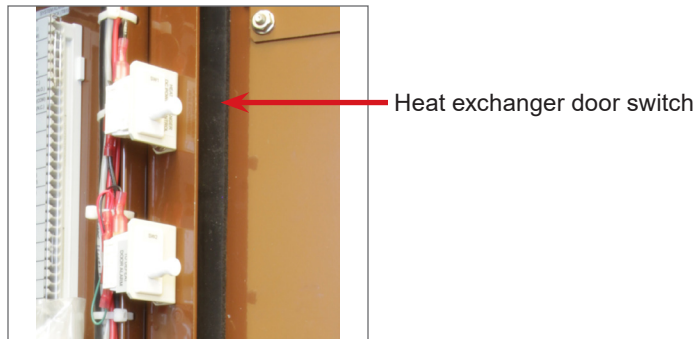

2. If the fans do not turn on, carefully apply heat to the heat exchanger thermostat using a heat gun. The fans should turn on above 30°C (86°F).

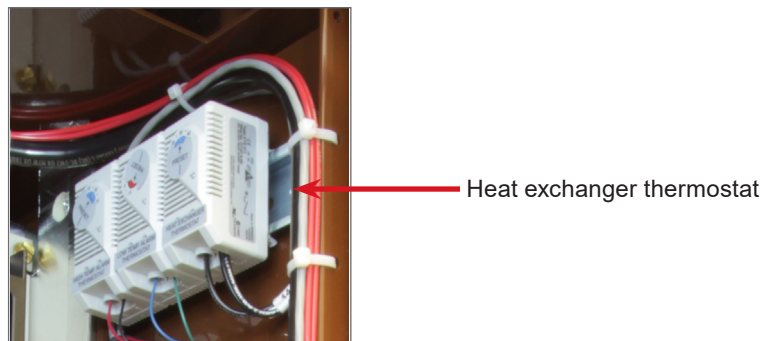

3. Operation of the inner loop fans can be verified through visual inspection.
4. Unplug one of the outer loop fan connectors and listen for a noticeable drop in the sound level of the outside fans. Plug the fan connector back in.
5. Repeat Step 4 for the second outer loop fan.

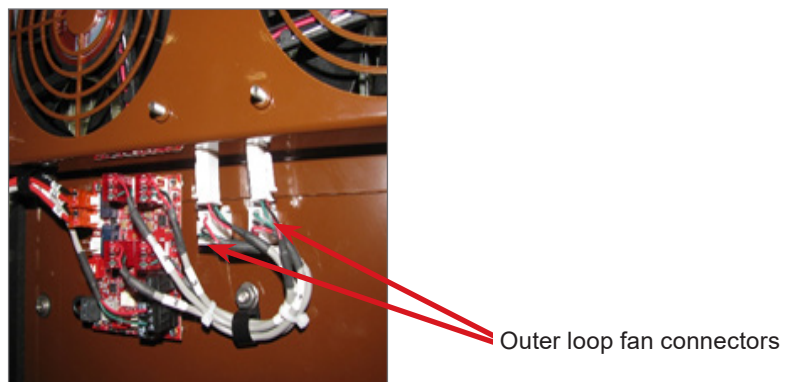

8.2 Heat exchanger fan replacement procedure

Part number: 7401059-001

A Fan Fail alarm indicates failure of either an inner loop or outer loop fan.

8.2.1 Removing the inner loop fan

1. Perform the fan test procedure in section 8.1 to identify which interior fan has failed.
2. Push the plunger of the heat exchanger power door switch back to its normal resting position so all fans stop.
3. Unplug the two inner loop fan connectors.
4. Gently pull the fan PCB below the fan mount bracket off of its supports.
5. Remove the four nuts securing the fan mount bracket to the door and remove the bracket.
6. Remove the failed fan by removing the four fan retaining screws.

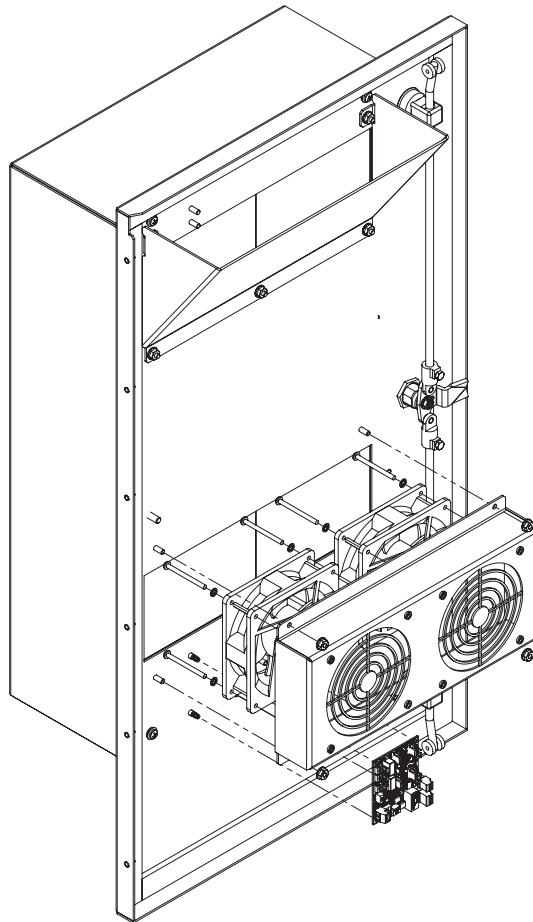

Figure 15 — Inner loop fan replacement

8.2.2 Removing the outer loop fan

1. Remove the exterior shroud by removing the four interior screws securing the shroud to the door. This will expose the outer loop fans.
2. Perform the fan test procedure in section 8.1 to identify which exterior fan has failed.

NOTE

Use extreme care when inspecting the rotating fans as there are no fan guards.

3. Push the plunger of the heat exchanger power door switch back to its normal resting position so all fans stop.
4. Remove the fan retaining assembly from the door by removing the four nuts (two on each side) using a wrench or nut driver.
5. Remove the failed fan by removing the four fan retaining screws and nuts.

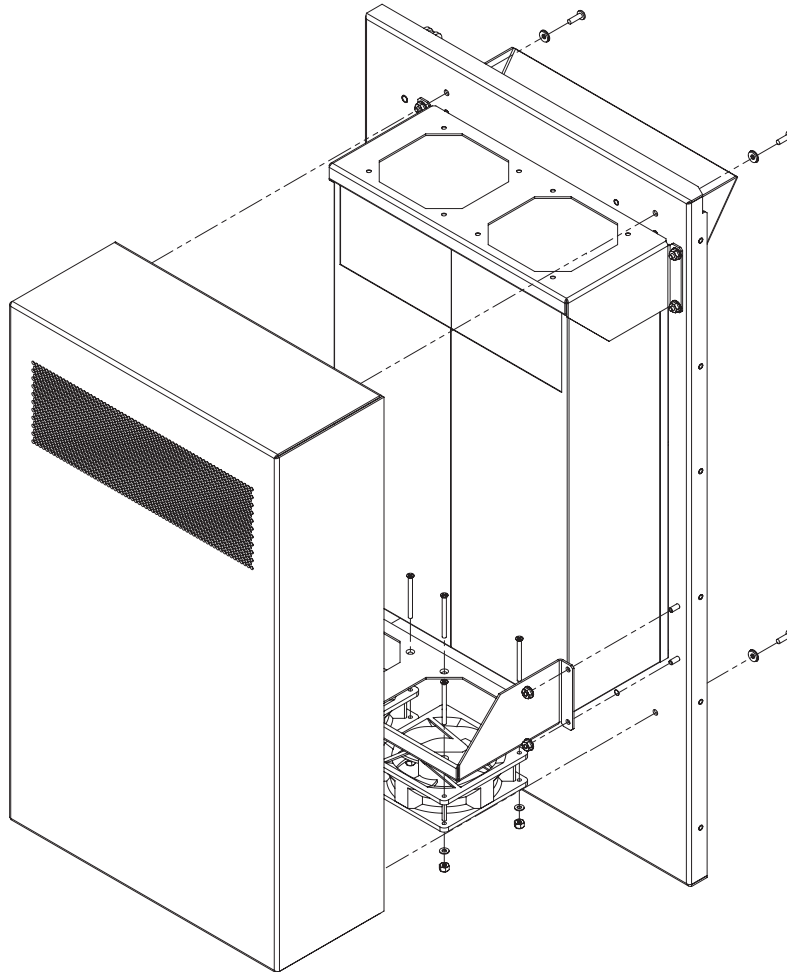

Figure 16 — Outer loop fan replacement

8.2.3 Replacing the interior and exterior fan

1. Locate the airflow direction indicator on the side of the frame of the replacement fan.
2. Orient the arrow as follows:
 - Interior fan** Arrow points out toward the inside of the enclosure
 - Exterior fan** Arrow points up towards the inside of the heat exchanger core
3. Secure the replacement fan to the assembly using the existing hardware. Use one of the other installed fans as a guide for hardware installation.
4. Tighten hardware only to the point that it is snug and the fan bezel does not bend.
5. Re-assemble the fan mounting assembly to the door and reconnect the fan.
6. Perform the fan test procedure in section 8.1 to verify all fans are rotating and that the Fan Fail alarm is not active.
7. Re-attach the exterior shroud to the front door if it was removed.

9. Warranty statement and service information

9.1 Technical support

In Canada and the USA, call toll free 1.888.462.7487

Customers outside Canada and the USA, call +1.604.436.5547

9.2 Warranty statement

For full information details review Alpha's online Warranty statement at www.alpha.ca/support.

9.3 Product warranty

Alpha warrants that for a period of two years from the date of shipment its products shall be free from defects under normal authorized use consistent with the product specifications and Alpha's instructions, the terms of the manual will take precedence.

The warranty provides for repairing, replacing or issuing credit (at Alpha's discretion) for any equipment manufactured by it and returned by the customer to the factory or other authorized location during the warranty period.

There are limitations to this warranty coverage. The warranty does not provide to the customer or other parties any remedies other than the above. It does not provide coverage for any loss of profits, loss of use, costs for removal or installation of defective equipment, damages or consequential damages based upon equipment failure during or after the warranty period. No other obligations are expressed or implied. Warranty also does not cover damage or equipment failure due to causes external to the unit including, but not limited to, environmental conditions, water damage, power surges or any other external influence.

The customer is responsible for all shipping and handling charges. Where products are covered under warranty Alpha will pay the cost of shipping the repaired or replacement unit back to the customer.

9.4 Battery warranty

Note that battery warranty terms and conditions vary by battery and by intended use. Contact your Alpha sales representative or the Technical Support team at the above number to understand your entitlements under Battery Warranty.

9.5 Warranty claims

Any claim under this Limited Warranty must be made in writing to Alpha **before** sending material back. Alpha will provide Product return instructions upon approval of return request. A Service Repair Order (SRO) or Return Authorization (RA) number will be issued ensuring that your service needs are handled promptly and efficiently.

Claims must be made online at: www.alpha.ca.

9.6 Service information

For a list of international service centers, refer to the Alpha website: www.alpha.ca.

10. Acronyms and definitions

AC	Alternating current
ANSI	American National Standards Institute
AWG	American Wire Gauge
BTU	British thermal unit
CAN	Controller area network
CEC	Canadian Electrical Code
CPC	Central Power Hub
CSA	Canadian Standards Association
CX	Cordex™ series; for example CXC for Cordex System Controller
DC	Direct current
DHCP	Dynamic Host Configuration Protocol
EIA	Electronic Industries Alliance
EMC	Electromagnetic compatibility
EMI	Electromagnetic interference
ERM	Electromagnetic Compatibility and Radio Spectrum Matters
ESD	Electrostatic Discharge
FCC	Federal Communications Commission (for the US)
GFCI	Ground fault circuit interrupter
HVSD	High voltage shutdown
IEC	International Electrotechnical Commission
IEEE	Institute of Electrical and Electronics Engineers
IP	Internet Protocol
LED	Light emitting diode
LVD	Low voltage disconnect
MIL	One thousandth of an inch; used in expressing wire cross sectional area
MOV	Metal oxide varistor
MTBF	Mean time between failures
NC	Normally closed
NEC	National Electrical Code (for the US)
NO	Normally open
OSHA	Occupational Safety & Health Administration
OSP	OutSide Plant
OVP	Over voltage protection
RU	Rack unit (1.75")
TCP/IP	Transmission Control Protocol / Internet Protocol
THD	Total harmonic distortion
TVSS	Transient Voltage Surge Suppressor
UL	Underwriters Laboratories
UATS	Universal Automatic Transfer Switch
VRLA	Valve regulated lead acid

11. Certification

About CSA and NRTL

CSA (Canadian Standards Association also known as CSA International) was established in 1919 as an independent testing laboratory in Canada. CSA received its recognition as an NRTL (Nationally Recognized Testing Laboratory) in 1992 from OSHA (Occupational Safety and Health Administration) in the United States of America (Docket No. NRTL-2-92). This was expanded and renewed in 1997, 1999, and 2001. The specific notifications were posted on OSHA's official website as follows:

- Federal Register #: 59:40602 - 40609 [08/09/1994]
- Federal Register #: 64:60240 - 60241 [11/04/1999]
- Federal Register #: 66:35271 - 35278 [07/03/2001]

When these marks appear with the indicator “C and US” or “NRTL/C” it means that the product is certified for both the US and Canadian markets, to the applicable US and Canadian standards. (1)

Alpha rectifier and power system products, bearing the aforementioned CSA marks, are certified to CSA C22.2 No. 60950-01 and UL 60950-01. Alpha UPS products, bearing the aforementioned CSA marks, are certified to CSA C22.2 No. 107.3 and UL 1778.

As part of the reciprocal, US/Canada agreement regarding testing laboratories, the Standards Council of Canada (Canada's national accreditation body) granted Underwriters Laboratories (UL) authority to certify products for sale in Canada. (2)

Only Underwriters Laboratories may grant a licence for the use of this mark, which indicates compliance with both Canadian and US requirements. (3)



NRTLs capabilities

NRTLs are third party organizations recognized by OSHA, US Department of Labor, under the NRTL program.

The testing and certifications are based on product safety standards developed by US based standards developing organizations and are often issued by the American National Standards Institute (ANSI). (4)

The NRTL determines that a product meets the requirements of an appropriate consensus-based product safety standard either by successfully testing the product itself, or by verifying that a contract laboratory has done so, and the NRTL certifies that the product meets the requirements of the product safety standard. (4)

Governance of NRTL

The NRTL Program is both national and international in scope with foreign labs permitted.

- (1) www.csagroup.org
- (2) www.scc.ca
- (3) www.ulc.ca
- (4) www.osha.gov

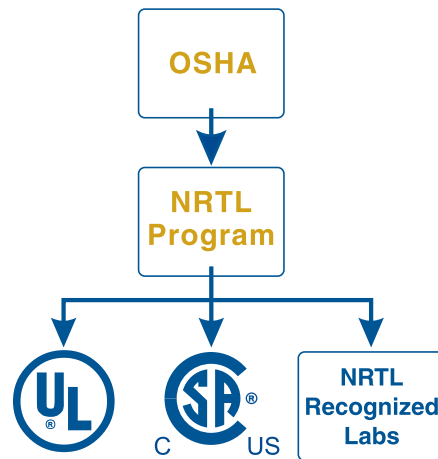

 an Energy company	
TITLE:	RPN ENCLOSURE TE33-1820 OUTLINE
SIZE [DWG NO.]:	B [0570203-06]
SCALE:	1:8 SHEET 1 OF 1

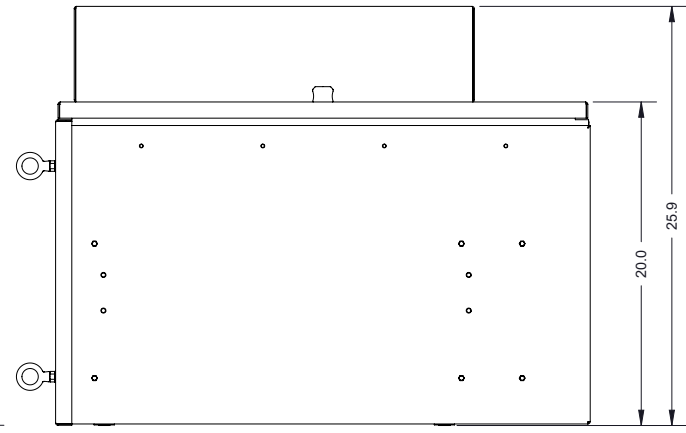
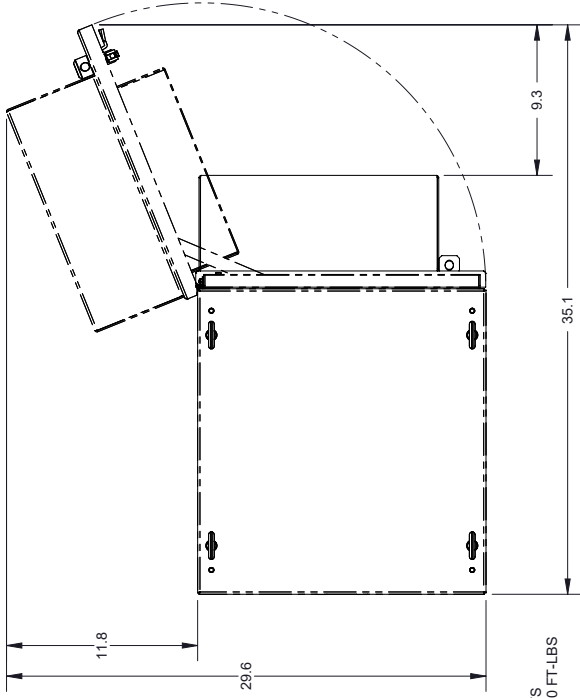
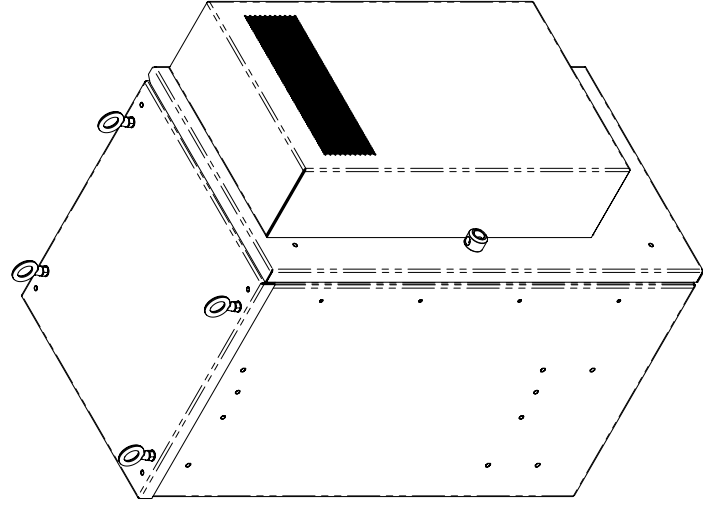

4X 3/8-16 RIVNUTS
TORQUE TO 15-20 FT-LBS

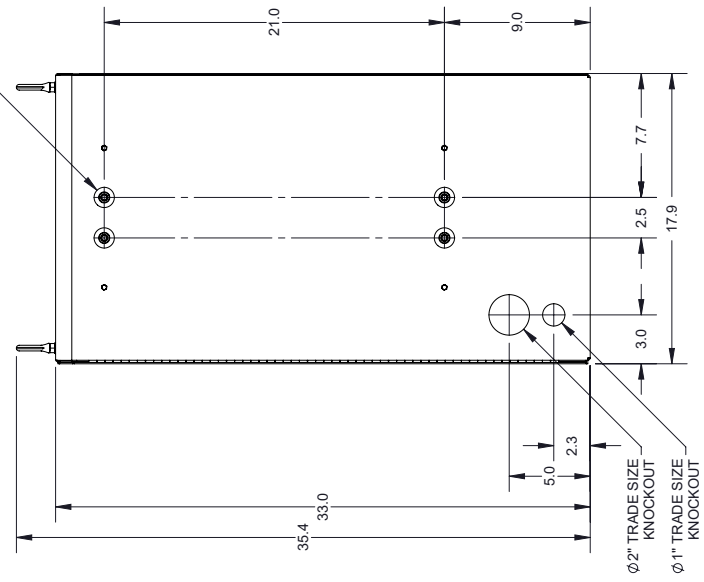

Ø2" TRADE SIZE
KNOCKOUT
Ø1" TRADE SIZE
KNOCKOUT

CORDEX 48-1.2kW RECTIFIER SHELF w/ MAIN BREAKER LOADCENTRE AC POWER DISTRIBUTION WIRING:

* USE SUPPLIED 12/3 SJT POWER CORDSETS

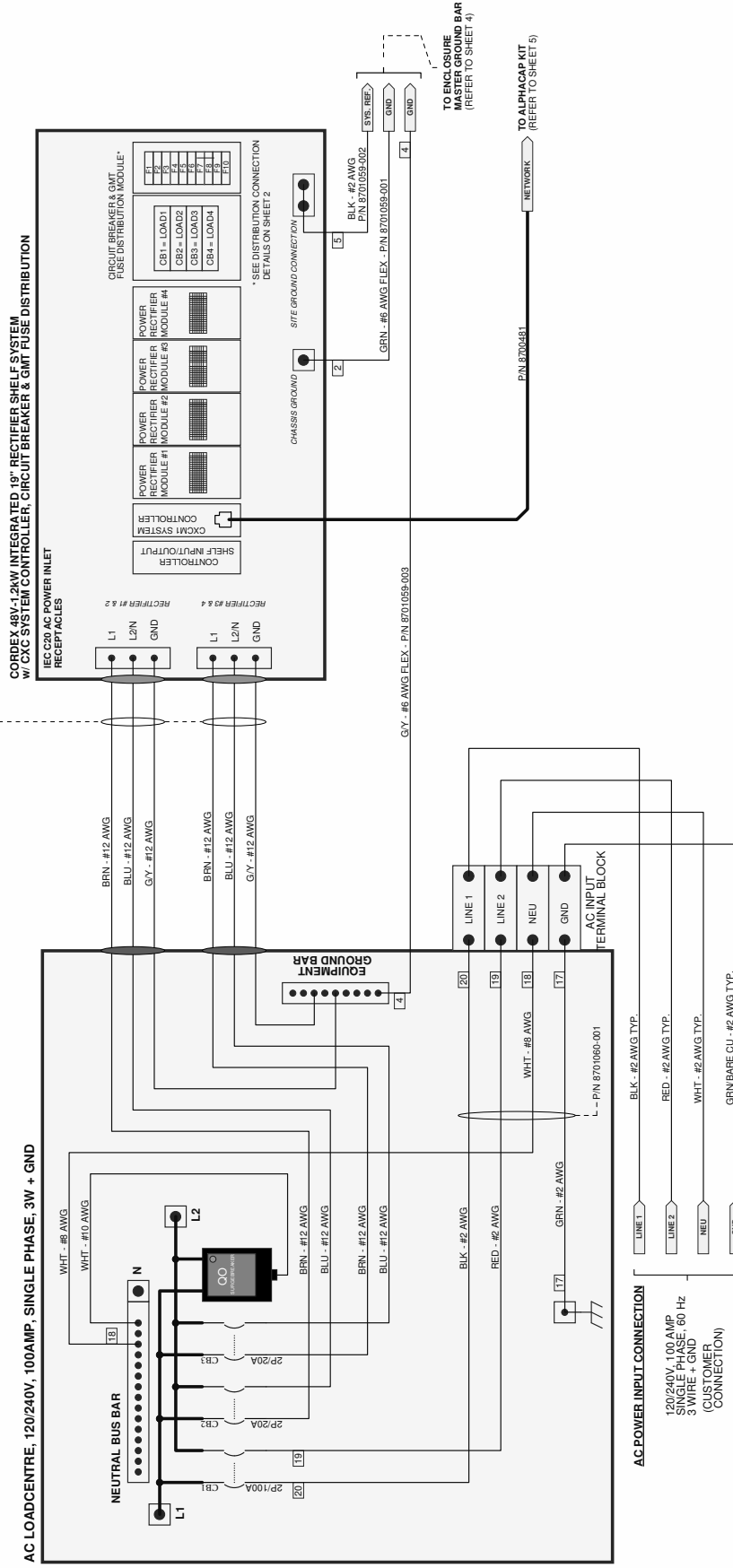

CORDEX 48-1.2kW RECTIFIER SHELF BREAKER AND FUSE DISTRIBUTION & CXC SYSTEM CONTROLLER INPUT/OUTPUT WIRING:

CORDEX 48V-1.2kW INTEGRATED 19" POWER RECTIFIER MODULE SHELF SYSTEM w/ CXCM1 SYSTEM CONTROLLER, 4 LOAD BREAKER POS, BATTERY LVD AND 10 POS GMT FUSE DISTRIBUTION

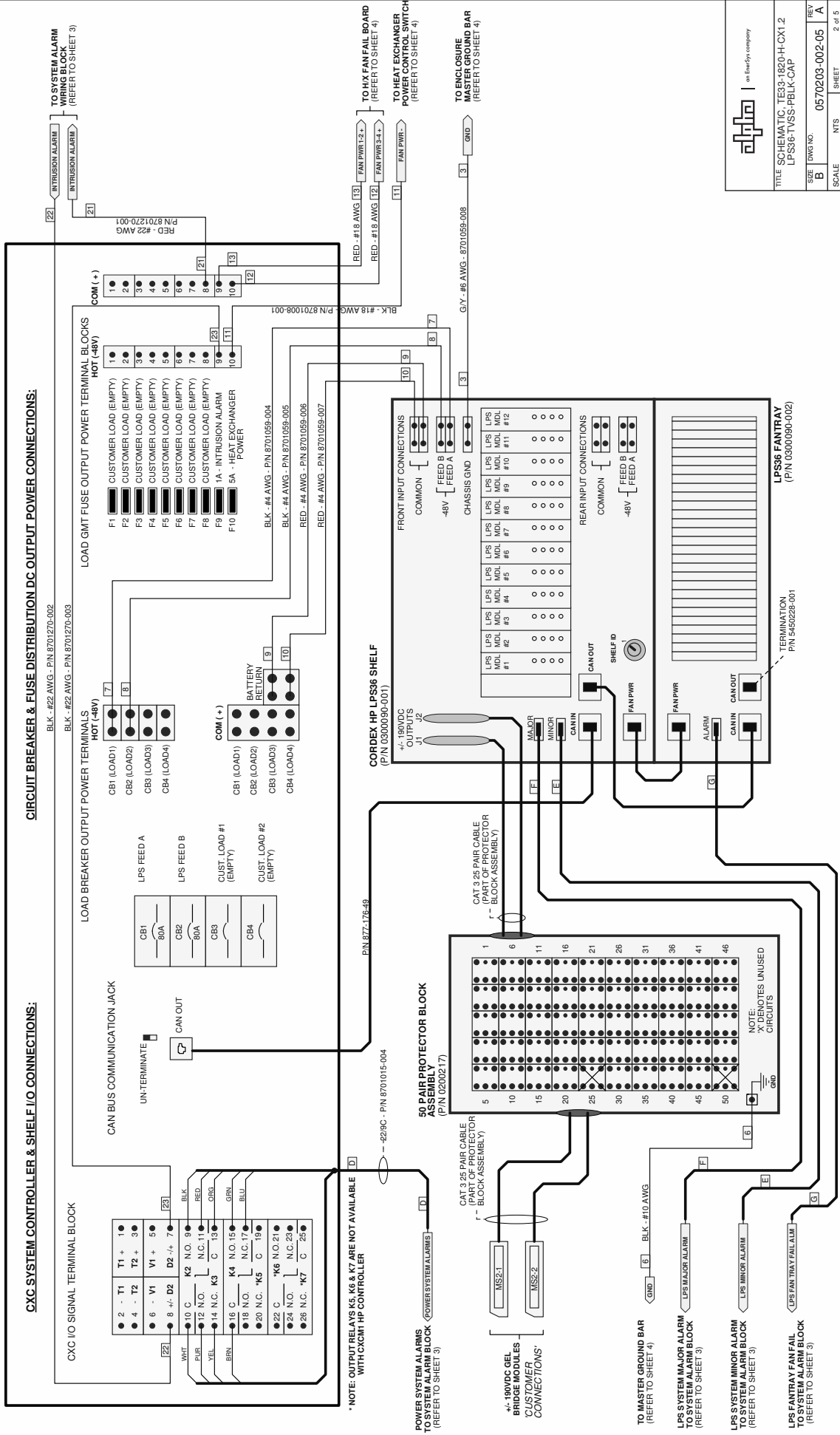

ENCLOSURE ALARM BLOCK WIRING:

ENCLOSURE TEMPERATURE ALARM THERMOSTAT

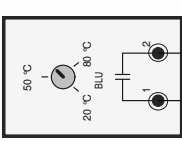

ENCLOSURE TEMPERATURE ALARM THERMOSTAT

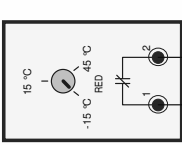

FACTORY DEFAULT SETTINGS:
 HIGH TEMP = 60 °C (140 °F)
 LOW TEMP = -15 °C (5 °F)

FRONT DOOR INTRUSION SWITCH

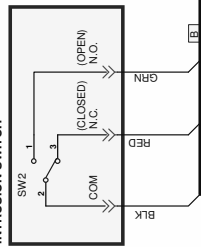

- FROM 1/2 FAN FAN BOARD (REFER TO SHEET 4)
- FROM RECTIFIER SHELF (REFER TO SHEET 2)
- FROM LPS SHELF (REFER TO SHEET 2)
- FROM LPS MAJOR ALARM (REFER TO SHEET 2)
- FROM LPS FAN TRAY ALARM RELAY (REFER TO SHEET 2)

SYSTEM ALARM WIRING PUNCH-DOWN '66' BLOCK

ALARM OUTPUT SIGNALS

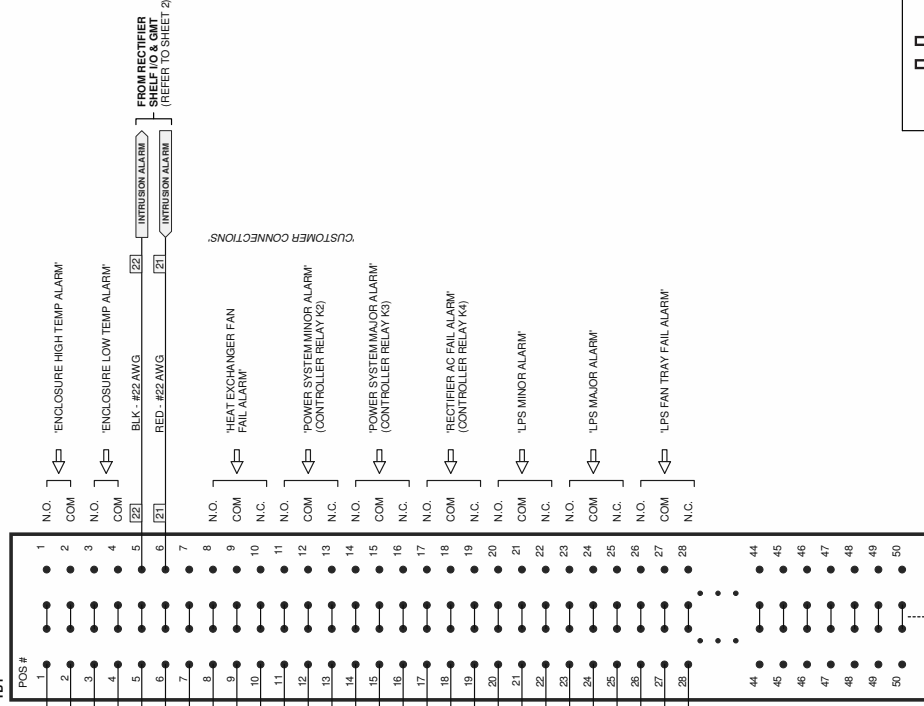

INSTALL BRIDGING CLIPS IN ALL 50 POSITIONS

alpha | an Emerson company

TITLE SCHEMATIC: TES3-1820-H-CX1.2
 LPS36-TVSS-FBLK-CAP

SIZE	DWG NO.	REV
B	0570203-002-05	A
SCALE	NTS	SHEET
		3 of 4

REV	DESCRIPTION	DATE	CHK
1	UTL		

FRONT DOOR HEAT EXCHANGER DC POWER & MASTER GROUND BAR WIRING:

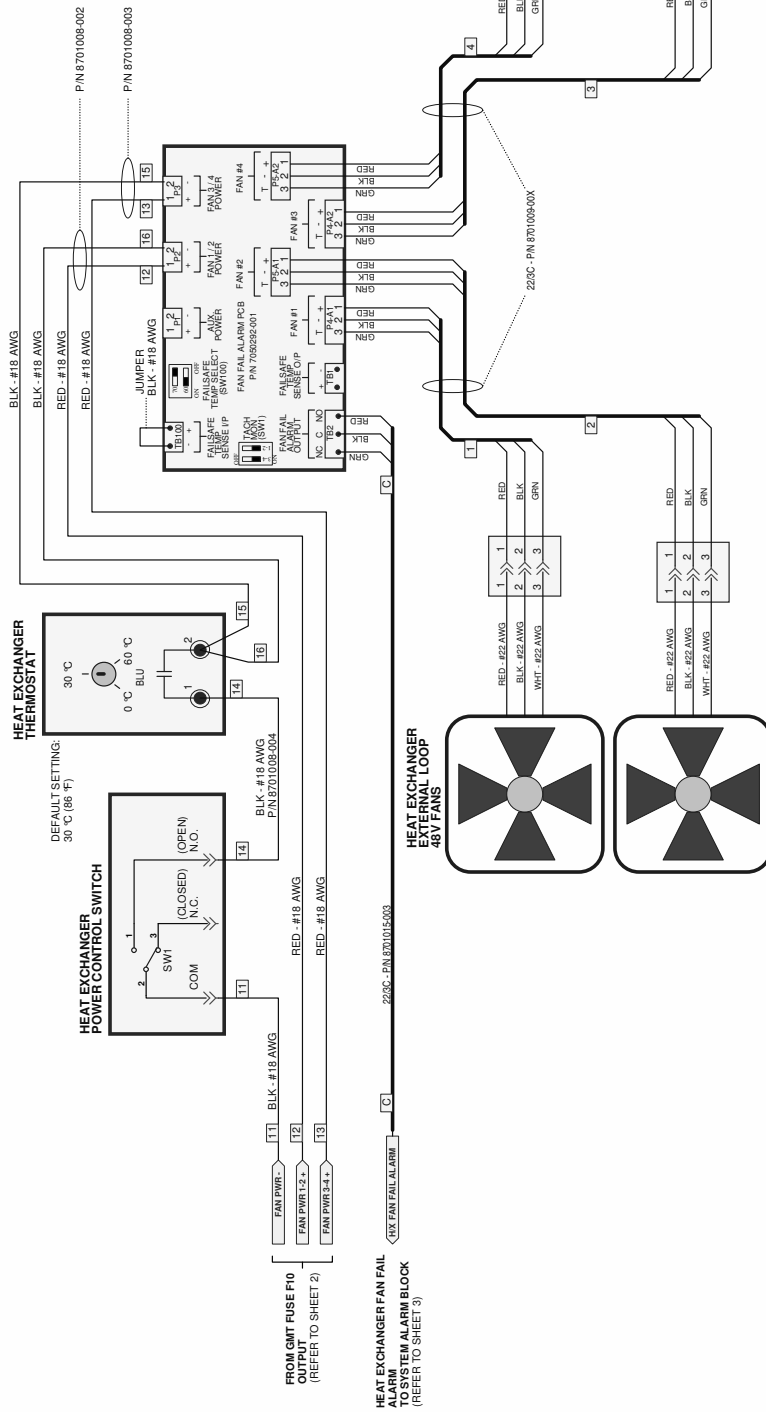

ENCLOSURE MASTER GROUND BAR TERMINATIONS:

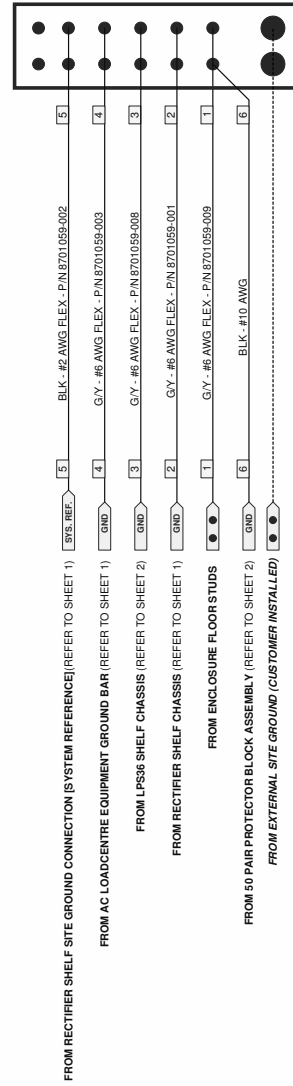



 TITLE SCHEMATIC, TES3-1820-H-CX1.2
 LPS36-TVSS-PBLK-CAP
 SCALE B
 NTS
 SHEET 4 of 5
 REV A
 0570203-002-05
 DWG NO.

ALPHACAP / ROUTER TO 1.2KW SHELF DISTRIBUTION WIRING:

(P/N 0370516-001)

CORDEX 48V-1.2KW RECTIFIER SHELF DISTRIBUTION

LOAD BREAKER OUTPUT AND BATTERY POWER TERMINALS

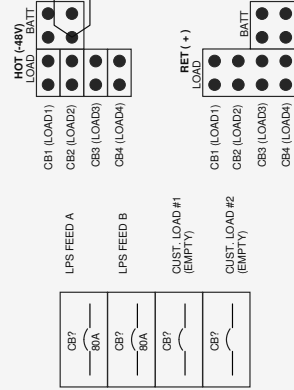

LOAD GMT FUSE OUTPUT POWER TERMINAL BLOCKS

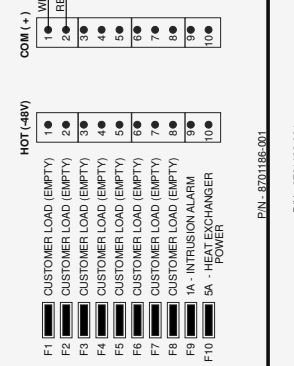

ALPHACAP - 665W SHORT DURATION BACK UP MODULE

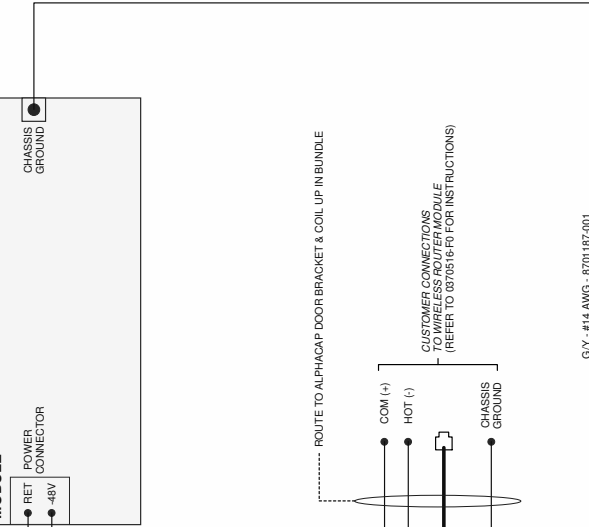

PN-8701188-001
PN-8701188-001

ROUTE TO ALPHACAP DOOR BRACKET & COIL UP IN BUNDLE

FROM NETWORK PORT ON CXCOM1
TO WIRELESS ROUTER MODULE
(REFER TO SHEET 1)

PN-8720981

GY. #14 AWG - P.N.8701189-001

RED. #18 AWG
BLK. #18 AWG

COM (+)
HOT (-)
CHASSIS GROUND

GY. #14 AWG - 8701187-001

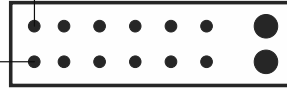

ENCLOSURE MASTER GROUND BAR



TITLE SCHEMATIC: TE93-1820-H-CX1.2
LPS36-TVSS-FBLK-CAP

SIZE	DWG NO.	REV
B	0570203-002-05	A
SCALE	NTS	SHEET
		5 of 5



Alpha Technologies Ltd. | 7700 Riverfront Gate, Burnaby, BC V5J 5M4 CANADA
Toll Free North America: +1.800.667.8743 | Outside North America +1.604.436.5547 | Technical Support +1.888.462.7487
For more information visit our website at: www.alpha.com
© 2021 Alpha Technologies Ltd. All Rights Reserved. Trademarks and logos are the property of Alpha Technologies Ltd. and its affiliates unless otherwise noted. Subject to revisions without prior notice. E. & O.E.

www.alpha.com
0570203-J0 REV B (04/2021)