



an EnerSys company

# Alpha iDAS Aggregator

## Models:

8-Port iDAS Aggregator

4-Port iDAS Aggregator

User Guide ID: 0120046-J0

Effective: 07/2021



**Read this manual carefully.**

Learn how to protect your equipment from damage and fully understand its functions.



# Alpha iDAS Aggregator

8-Port iDAS Aggregator

4-Port iDAS Aggregator

## NOTE

---

Photographs contained in this manual are for illustrative purposes only. These photographs may not match your installation.

## NOTE

---

Operator is cautioned to review the drawings and illustrations contained in this manual before proceeding. If there are questions regarding the safe operation of this powering system, contact Alpha Technologies or your nearest Alpha representative.

## NOTE

---

Alpha shall not be held liable for any damage or injury involving its enclosures, power supplies, generators, batteries, or other hardware if used or operated in any manner or subject to any condition inconsistent with its intended purpose, or if installed or operated in an unapproved manner, or improperly maintained.

## For technical support, contact Alpha Technologies:

Canada and US: +1 888 462 7487

International: +1 604 436 5547

Email: [support@alpha.ca](mailto:support@alpha.ca)

## Copyright

Copyright © 2021 Alpha Technologies Ltd. All rights reserved. Alpha is a registered trademark of Alpha Technologies.

No part of this documentation shall be reproduced, stored in a retrieval system, translated, transcribed, or transmitted in any form or by any means manual, electric, electronic, electromechanical, chemical, optical, or otherwise without prior explicit written permission from Alpha Technologies.

This document, the software it describes, and the information and know-how they contain constitute the proprietary, confidential and valuable trade secret information of Alpha Technologies, and may not be used for any unauthorized purpose, or disclosed to others without the prior written permission of Alpha Technologies.

The material contained in this document is for information only and is subject to change without notice. While reasonable efforts have been made in the preparation of this document to assure its accuracy, Alpha Technologies assumes no liability resulting from errors or omissions in this document, or from the use of the information contained herein. Alpha Technologies reserves the right to make changes in the product design without reservation and without notification to its users.

# Contents

- 1. Safety..... 6**
  - 1.1 Safety symbols..... 6
  - 1.2 General safety..... 6
  - 1.3 Mechanical safety ..... 6
  - 1.4 Electrical safety..... 7
  - 1.5 Battery safety ..... 7
  
- 2. Product overview ..... 8**
  - 2.1 Introduction ..... 8
  - 2.2 Features and benefits ..... 8
  - 2.3 Features and benefits ..... 9
  - 2.4 Part numbers ..... 10
  
- 3. Specifications..... 11**
  - 3.1 8-Port iDAS Aggregator specifications..... 11
  - 3.2 4-Port iDAS Aggregator specifications..... 13
  
- 4. Features..... 15**
  - 4.1 iDAS Aggregator modules..... 15
  - 4.2 iDAS Aggregator alarms ..... 15
  - 4.3 Mounting options..... 15
  
- 5. Site evaluation and pre-installation..... 16**
  - 5.1 Packing materials..... 16
  - 5.2 Returns for service..... 16
  - 5.3 Check for damage..... 16
  - 5.4 General receipt of shipment..... 16
  
- 6. Installation..... 17**
  - 6.1 General instructions ..... 17
  - 6.2 Safety precautions ..... 17
  - 6.3 Installation tools ..... 17
  - 6.4 Materials included in the package..... 17
  - 6.5 Mounting options..... 19

6.6	Thermal management.....	22
6.7	Wiring the 8-Port iDAS Aggregator .....	23
6.8	Installing the wire cover and securing the wires .....	26
6.9	Wiring the 4-Port iDAS Aggregator .....	28
6.10	Troubleshooting .....	29
6.11	Service parts .....	30
<b>7.</b>	<b>Wiring.....</b>	<b>31</b>
7.1	Calculating output wire size requirements .....	31
<b>8.</b>	<b>Warranty statement and service information .....</b>	<b>32</b>
8.1	Technical support .....	32
8.2	Warranty statement.....	32
8.3	Product warranty.....	32
8.4	Battery warranty .....	32
8.5	Warranty claims .....	32
8.6	Service information .....	32
<b>9.</b>	<b>Certification .....</b>	<b>33</b>

# Figures

- Figure 1: 8-Port iDAS Aggregator (front view) ..... 8
- Figure 2: 4-Port iDAS Aggregator (front view) ..... 8
- Figure 3: 8-Port iDAS Aggregator, with cover kit installed (front view) ..... 9
- Figure 4: Bracket installation, flush rack mount..... 19
- Figure 5: Installation flush rack mount..... 19
- Figure 6: Bracket installation, offset rack mount..... 20
- Figure 7: Installation, offset rack mount..... 20
- Figure 10: Bracket installation, rear wall mount..... 21
- Figure 8: Bracket installation, wall mount..... 21
- Figure 9: Installation, wall mount ..... 21
- Figure 11: Installation, Rear Wall Mount..... 22
- Figure 12: Input and output wiring ..... 23
- Figure 13: Alarm positions ..... 25
- Figure 14: Wire cover, normal installation ..... 26
- Figure 15: Wire cover, complete..... 26
- Figure 16: Channel designation label ..... 27
- Figure 17: Channel label install front ..... 27
- Figure 18: Channel label install top ..... 27
- Figure 19: Wiring connections ..... 28

# 1. Safety

---

## Save these instructions

This manual contains important safety instructions that must be followed during the installation, servicing, and maintenance of the product. Keep it in a safe place. Review the drawings and illustrations contained in this manual before proceeding. If there are any questions regarding the safe installation or operation of this product, contact Alpha Technologies or the nearest Alpha representative. Save this document for future reference.

### 1.1 Safety symbols

To reduce the risk of injury or death, and to ensure the continued safe operation of this product, the following symbols have been placed throughout this manual. Where these symbols appear, use extra care and attention.

The use of ATTENTION indicates specific regulatory/code requirements that may affect the placement of equipment or installation procedures.

 **NOTE**  
A NOTE provides additional information to help complete a specific task or procedure. Notes are designated with a check mark, the word NOTE, and a rule beneath which the information appears.

 **CAUTION!**  
CAUTION indicates safety information intended to PREVENT DAMAGE to material or equipment. Cautions are designated with a yellow warning triangle, the word CAUTION, and a rule beneath which the information appears.

 **WARNING!**  
WARNING presents safety information to PREVENT INJURY OR DEATH to personnel. Warnings are indicated by a shock hazard icon, the word WARNING, and a rule beneath which the information appears.

 **HOT!**  
The use of HOT presents safety information to PREVENT BURNS to the technician or user.

### 1.2 General safety

 **WARNING!**  
This system is designed to be installed in a restricted access location that is inaccessible to the general public.

### 1.3 Mechanical safety

- Keep hands and tools clear of fans. Fans are thermostatically controlled and switch on automatically.
- Power supplies can reach extreme temperatures under load.
- Use caution around sheet metal components and sharp edges.

## 1.4 Electrical safety



### WARNING!

**Hazardous voltages are present at the input of power systems. The DC output from rectifiers and batteries, though not dangerous in voltage, has a high short-circuit current capacity that may cause severe burns and electrical arcing.**

Before working with any live battery or power system, follow these precautions:

- Remove all metallic jewelry, such as watches, rings, metal rimmed glasses, or necklaces.
- Wear safety glasses with side shields at all times during the installation.
- Use OSHA approved insulated hand tools.



### WARNING!

**Lethal voltages are present within the power system. Always assume that an electrical connection or conductor is energized. Check the circuit with a voltmeter with respect to the grounded portion of the enclosure (both AC and DC) before performing any installation or removal procedure.**

- Do not work alone under hazardous conditions.
- A licensed electrician is required to install permanently wired equipment. Input voltages can range up to 277Vac nominal. Ensure that the utility power is disconnected and locked out before performing any installation or removal procedure.
- Ensure that no liquids or wet clothes come into contact with internal components.
- Hazardous electrically live parts inside this unit are energized from the batteries even when the AC input power is disconnected.

## 1.5 Battery safety

- Servicing and connection of batteries must be performed by, or under the direct supervision of, personnel knowledgeable of batteries and the required safety precautions.
- Always wear eye protection, rubber gloves, and a protective vest when working near batteries. Remove all metallic objects from your hands and neck.
- Use OSHA approved insulated hand tools. Do not rest tools on top of batteries.
- Batteries contain or emit chemicals known to cause cancer and birth defects or other reproductive harm. Battery post terminals and related accessories contain lead and lead compounds. Wash your hands after handling batteries.



### WARNING!

**Follow battery manufacturer's safety recommendations when working around battery systems. Do not smoke or introduce an open flame when batteries (especially vented batteries) are charging. When charging, batteries vent hydrogen gas, which can explode.**

**Batteries are hazardous to the environment and shall be disposed at a recycling facility. Consult the battery manufacturer for recommended local authorized recyclers.**



## 2. Product overview

---

### 2.1 Introduction

Alpha iDAS Aggregator modules are Class 2 circuit aggregation devices. For iDAS, indoor small cell, and WiFi network equipment that consume more than 100 watts of power, Alpha's iDAS Aggregators enable the remote line powering over copper cable. By combining the unit with products from Alpha's eLimiter™ family, the iDAS Aggregator meets the requirements for NEC Class 2 safety, enabling service providers to use conventional cable to remotely power the equipment. Class 2 compliance eliminates the need for conduit, licensed electricians, and remote batteries, significantly improving the business case for the service provider.

The 8-Port iDAS Aggregator can terminate up to eight NEC Class 2 circuits, combining them into a single 48V nominal bulk output of up to 800 watts. The unit is extremely compact, and can be either rack or wall mounted. It is a front access device with all the user connections residing on the front face plate of the unit.



Figure 1: 8-Port iDAS Aggregator (front view)

The 4-Port iDAS Aggregator can terminate up to four NEC Class 2 circuits, combining them into a single 48V nominal bulk output of up to 400 watts. The unit is even more compact, and can be either shelf or wall mounted. It is a front access device with all the user connections residing on the front face plate of the unit.



Figure 2: 4-Port iDAS Aggregator (front view)

## 2.3 Features and benefits

- Aggregates up to eight NEC Class 2 inputs (8-Port iDAS Aggregator) or up to four NEC Class 2 inputs (4-Port iDAS Aggregator) into a single, 48Vdc nominal bulk output
- When deployed in conjunction with Alpha's eLimiter™ product family, meets the requirements for Class 2 circuits, even for remote devices that consume more than 100 watts of power
- Enables remote powering of iDAS, indoor small cells, and WiFi networks
- Dramatically reduces CAPEX by eliminating the need for conduit and certified installations
- Results in lower OPEX by eliminating the requirements for batteries at the remote sites
- Additional protection to cable termination terminal blocks can be achieved by using a cover kit



Figure 3: 8-Port iDAS Aggregator, with cover kit installed (front view)

## 2.4 Part numbers

The product, options, and accessories can be ordered by using the part numbers in the following tables.

### 2.4.1 8-Port iDAS Aggregator

Description	Part number
8-Port iDAS Aggregator module	0120046-001
8-Port iDAS Aggregator module, with cover kit	0120046-100
8 channel aggregator cover kit	0370270-001
Additional input terminal block	5350120
Additional output terminal block	5350124
Additional alarm terminal block	5350054

### 2.4.2 4-Port iDAS Aggregator

Description	Part number
4-Port iDAS Aggregator module	0120081-001
Additional input terminal block	5350120
Additional output terminal block	5350124
Additional alarm terminal block	5350054

## 3. Specifications

### 3.1 8-Port iDAS Aggregator

Electrical	
<b>Input voltage</b>	48Vdc nominal range: 35Vdc to 60Vdc (× 8 Class 2 inputs)
<b>Input power</b>	8 × 100VA Class 2 inputs: 800VA maximum
<b>Output voltage</b>	48Vdc nominal
<b>Output power</b>	≤800W
<b>Efficiency</b>	>98.5%
<b>Voltage drop IO</b>	200mV/A nominal
<b>Line insertion loss (per channel)</b>	<ul style="list-style-type: none"> <li>• 2 channels active: 1.8W per channel</li> <li>• 4 channels active: 1.6W per channel</li> <li>• 8 channels active: 1.5W per channel</li> </ul>
Connections	
<b>Input</b>	8 × 2-position plug-in TB, 0.05 mm <sup>2</sup> to 4.0 mm <sup>2</sup> (30 AWG to 12 AWG)
<b>Output</b>	2-position plug-in TB, 0.05 mm <sup>2</sup> to 6.0 mm <sup>2</sup> (30 AWG to 10 AWG)
<b>Alarm</b>	3-position plug-in TB, 0.08 mm <sup>2</sup> to 1.5 mm <sup>2</sup> (28 AWG to 16 AWG)
<b>Chassis ground</b>	Accept ¼ in. to ⅝ in. center to center, dual hole terminal lug, maximum width 18 mm (0.7 in.)
Mechanical	
<b>Dimensions (H × W × D)</b>	43.6 mm × 275 mm × 224.8 mm (1.72 in. × 10.83 in. × 8.85 in.)
<b>Weight</b>	2.7 kg (6 lb)
Environmental	
<b>Operating temperature</b>	
<b>Forced air cooling</b>	−40°C to 65°C (−40°F to 149°F) using fan tray or minimum cabinet air flow at 8.24 l/s (200 LFM)
<b>Convection cooling</b>	−40°C to 45°C (−40°F to 122°F) single shelf operation only or separated by 4.5 cm (1.75 in.) spacing
<b>Storage temperature</b>	−40°C to 85°C (−40°F to 185°F)
<b>Relative humidity</b>	0 to 95% non-condensing
<b>Elevation</b>	−500 m to 2800 m (1640 ft. to 9186 ft.)
<b>Heat dissipation</b>	<10.9 W (<37.5 BTU/hr)
<b>NEBS/Telcordia</b>	Class 3 - Protected Equipment in Severe Outside Environment
Features	
<b>Alarm relays</b>	1 × Form C contact (triggered if any channel opens)
<b>Alarm indicating LEDs</b>	<ul style="list-style-type: none"> <li>• System OK (green)</li> <li>• Minor alarm (yellow)</li> <li>• Major alarm (red)</li> </ul>
Reliability	
<b>MTBF</b>	>400,000 hours at 30°C (86°F) ambient, test model Telcordia SR-332, Issue 2 (2006)
Agency compliance	
<b>Safety</b>	CSA/UL/IEC 62368-1 Edition 2.0 (2014)
<b>EMC</b>	ETSI EN 300 386

<b>Emissions</b>	FCC CFR 47, Part 15, Class A
<b>Immunity</b>	<ul style="list-style-type: none"> <li>• EN 61000-4-2</li> <li>• EN 61000-4-3</li> <li>• EN 61000-4-4</li> <li>• EN 61000-4-5</li> <li>• EN 61000-4-6</li> <li>• EN 61000-4-8</li> </ul>
<b>NEBS/Telcordia</b>	<ul style="list-style-type: none"> <li>• GR-1089-CORE</li> <li>• GR-63-CORE</li> </ul>
<b>NEC</b>	Input circuits need to be compliant to NEC article 725 (CEC article 16-200) requirements for Class 2 power limited circuits) and need to be from the eLimiter product family
<b>Isolation</b>	2250Vdc electrical isolation between output and earth chassis (compliant with IEEE 802.3at standard to meet PoE+ isolation requirement)

## 3.2 4-Port iDAS Aggregator

Electrical	
<b>Input voltage</b>	48Vdc nominal range: 35Vdc to 60Vdc (× 4 Class 2 inputs)
<b>Input power</b>	4 × 100VA Class 2 inputs: 400VA maximum
<b>Output voltage</b>	48Vdc nominal
<b>Output power</b>	≤400W
<b>Efficiency</b>	>98.5%
<b>Voltage drop IO</b>	200mV/A nominal
<b>Line insertion loss (per channel)</b>	<ul style="list-style-type: none"> <li>• 2 channels active: 1.8W per channel</li> <li>• 4 channels active: 1.6W per channel</li> </ul>
Connections	
<b>Input</b>	4 × 2-position plug-in TB, 0.05 mm <sup>2</sup> to 4.0 mm <sup>2</sup> (30 AWG to 12 AWG)
<b>Output</b>	2-position plug-in TB, 0.05 mm <sup>2</sup> to 6.0 mm <sup>2</sup> (30 AWG to 10 AWG)
<b>Alarm</b>	3-position plug-in TB, 0.08 mm <sup>2</sup> to 1.5 mm <sup>2</sup> (28 AWG to 16 AWG)
<b>Chassis ground</b>	Accept ¼ in. to ⅝ in. center to center, dual hole terminal lug, maximum width 18 mm (0.7 in.)
Mechanical	
<b>Dimensions (H × W × D)</b>	43.2 mm × 167 mm × 224.8 mm (1.7 in. × 6.57 in. × 8.85 in.)
<b>Weight</b>	1.2 kg (2.6 lb)
Environmental	
<b>Operating temperature</b>	
<b>Forced air cooling</b>	−40°C to 65°C (−40°F to 149°F) with minimum cabinet air flow at 8.24 l/s (200 LFM)
<b>Convection cooling</b>	−40°C to 45°C (−40°F to 122°F) single shelf operation only or separated by 7.62 cm (3 in.) spacing
<b>Storage temperature</b>	−40°C to 85°C (−40°F to 185°F)
<b>Relative humidity</b>	0 to 95% non-condensing
<b>Elevation</b>	−500 m to 2800 m (1640 ft. to 9186 ft.)
<b>Heat dissipation</b>	<7.03 W (<24 BTU/hr)
Performance/features	
<b>Alarm indicating LEDs</b>	<ul style="list-style-type: none"> <li>• System OK (green)</li> <li>• Minor alarm (yellow)</li> <li>• Major alarm (red)</li> </ul>
<b>Alarm relays</b>	1 × Form C contact (triggered if any channel opens)
<b>Alarm relay states</b>	Contact state
<b>Energized</b>	<ul style="list-style-type: none"> <li>• C-NC: Open</li> <li>• C-NO: Closed</li> </ul>
<b>De-energized</b>	<ul style="list-style-type: none"> <li>• C-NC: Closed</li> <li>• C-NO: Open</li> </ul>
Reliability	
<b>MTBF</b>	>400,000 hours at 30°C (86°F) ambient, test model Telcordia SR-332, Issue 2 (2006)

Agency compliance	
<b>Safety</b>	CSA/UL/IEC 62368-1 Edition 2.0 (2014)
<b>EMC</b>	ETSI EN 300 386
<b>Emissions</b>	FCC CFR 47, Part 15, Class A
<b>Immunity</b>	<ul style="list-style-type: none"> <li>• EN 61000-4-2</li> <li>• EN 61000-4-3</li> <li>• EN 61000-4-4</li> <li>• EN 61000-4-5</li> <li>• EN 61000-4-6</li> <li>• EN 61000-4-8</li> </ul>
<b>NEC</b>	Input circuits need to be compliant to NEC article 725 (CEC article 16-200) requirements for Class 2 power limited circuits) and need to be from the eLimiter+ product family
<b>Isolation</b>	2250Vdc electrical isolation between output and earth chassis (compliant with IEEE 802.3at standard to meet PoE+ isolation requirement)

## 4. Features

---

### 4.1 iDAS Aggregator modules

Alpha iDAS Aggregator modules are Class 2 circuit aggregation devices. The 8-Port iDAS Aggregator can terminate up to eight NEC Class 2 circuits from an eLimiter+ system, combining them into a single 48V bulk output of up to 800 watts. The 4-Port iDAS Aggregator can terminate up to four NEC Class 2 inputs into a single 48V bulk output of up to 400 watts. Both the 8-Port and 4-Port iDAS Aggregator are wall mountable (front, bottom, or rear mount) while only the 8-Port iDAS Aggregator is rack mountable. Both the 8-Port and 4-Port iDAS Aggregators are front access devices with all the user connections residing on the front of the unit.

### 4.2 Status indicators

iDAS Aggregator modules have one LED per channel. LEDs are color coded to indicate aggregator status as follows:

LED state	Channel status
Off	Inputs are not powered
Green	Channel voltage present and current flowing to aggregator (normal behavior)
Blinking green	Channel voltage present and ready to supply current
Yellow	Internal ambient over temperature (>95°C; >203°F)
Blinking yellow	Channel input voltage out of range (>60V or <35V)
Red	100VA limitation exceeded or over current protection (>2.4A)
Blinking red	Channel high side and low side current imbalance (>0.7A)

### 4.3 Alarms

Alarms are activated for the following conditions:

- 100VA limitation exceeded or Over Current Protection (>2.4A)
- Channel high side and low side current imbalance (>0.7A)
- Internal ambient over temperature (>95°C; >203°F)
- Input voltage exceeds 60V

### 4.4 Mounting options

Depending on the site, there are different ways to mount the iDAS Aggregator. The units can be mounted in a rack or on the wall. The mounting brackets provided can be attached in different positions depending on the mounting needs of your specific site. Refer to "[Installation](#)" for details. The outline drawings at the back of this manual also provide the exact dimensions for each mounting option.









## 5. Site evaluation and pre-installation

### 5.1 Packing materials

We are committed to providing products and services that meet our customers' needs and expectations in a sustainable manner, while complying with all relevant regulatory requirements. As such, we strive to follow our quality and environmental objectives from product supply and development through to the packaging for our products.

Rectifiers and batteries are shipped on individual pallets and are packaged according to the manufacturer's guidelines.

Almost all of our packaging material is from sustainable resources and or is recyclable. See the following table for the material and its environmental codes.

 PAP/PCB	 PET	 PE-LD	 PS	 FE	 ALU	 NW
Cardboard	Polyethylene Terephthalate	Low Density Polyethylene	Polystyrene	Steel	Aluminum	Wood
Packing boxes Caps	Flexible film Packaging	Bubble wrap Shrink wrap Plastic bags	Foam	Strapping on pallets	Strapping on pallets	Pallets Lumber

### 5.2 Returns for service

Save the original shipping container. If the product needs to be returned for service, it should be packaged in its original shipping container. If the original container is unavailable, make sure that the product is packed with at least three inches of shock-absorbing material to prevent shipping damage.

Alpha Technologies is not responsible for damage caused by improper packaging of returned products.

### 5.3 Check for damage

Prior to unpacking the product, note any damage to the shipping container. Unpack the product and inspect the exterior for damage. If any damage is observed contact the carrier immediately.

Continue the inspection for any internal damage. In the unlikely event of internal damage, inform the carrier and contact us for advice on the impact of any damage.

### 5.4 General receipt of shipment

The inventory included with your shipment is dependant upon the options you have ordered. The options are clearly marked on the shipping container labels and bill of materials.

Call us if you have any questions before you proceed: +1 888 462 7487.

## 6. Installation

This chapter is provided for qualified personnel to install the system and provides cabling details and notes on cable sizing for DC applications.

### 6.1 General instructions

Connections to the iDAS Aggregator system must comply with all local codes and ordinances.



#### WARNING!

**The DC output of the iDAS Aggregator; though not dangerous in voltage; has a high short circuit current capacity that may cause severe burns and electrical arcing.**

### 6.2 Safety precautions

Refer to ["Safety" on page 6](#) before beginning this installation.

### 6.3 Installation tools

Various insulated tools are essential for product installation. Use the following as a guide:

- Phillips head screwdriver, #2 (tip size 3/16")
- Slot head screwdriver (blade size 1/8")
- Digital voltmeter equipped with test leads
- Cutters, crimpers, and wire strippers 0.25 mm<sup>2</sup> to 16 mm<sup>2</sup> (24 AWG to 6 AWG)

### 6.4 Materials included in the package

#### 6.4.1 8-Port iDAS Aggregator

Description	Quantity
8-Port iDAS Aggregator module	1
2-position plug-in input terminal block	8
2-position plug-in output terminal block	1
3-position plug-in alarm terminal block	1
Mounting bracket	2
#8-32 pan head screw for mounting bracket	4
Front terminal block cover	1
Male-female stand-off, M3-0.5 × 52 mm	4
M3-0.5 pan head screw for terminal block	4
Channel label	2

## 6.4.2 4-Port iDAS Aggregator

Description	Quantity
4-Port iDAS Aggregator module	1
2-position plug-in input terminal block	4
2-position plug-in output terminal block	1
3-position plug-in alarm terminal block	1
Front terminal block cover	1
Male-female stand-off, M3-0.5 × 52 mm	4
M3-0.5 pan head screw for terminal block	4
Channel label	2

## 6.5 Mounting options

### 6.5.1 19-inch flush rack mount (use an Alpha adaptor for 23-inch rack)

#### ✓ NOTE

The 4-Port iDAS Aggregator is a shelf or wall mount system. This section was written for the 8-Port iDAS Aggregator although content can be referenced for the 4-Port iDAS Aggregator.

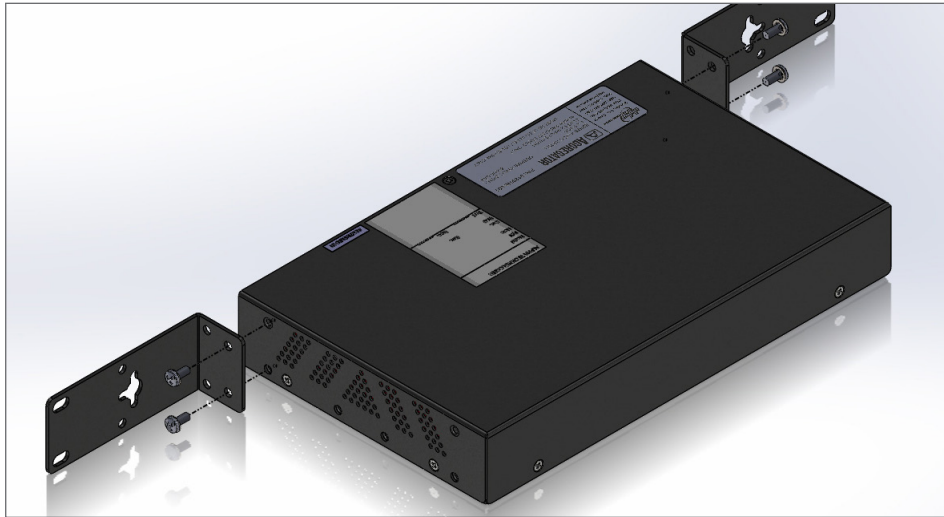

Figure 4: Bracket installation, flush rack mount

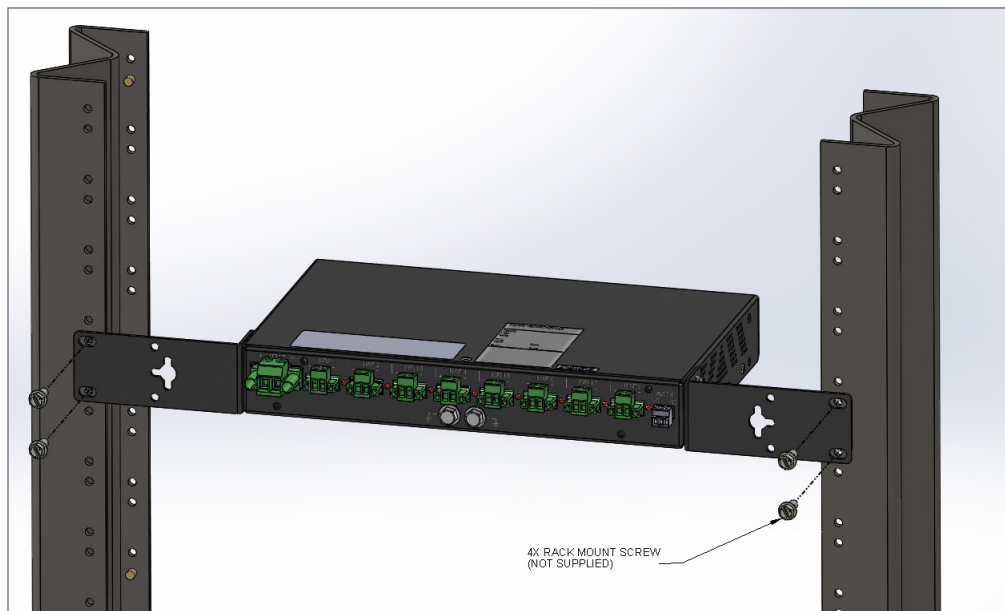

Figure 5: Installation flush rack mount

### 6.5.2 19-inch offset rack mount (use an Alpha adaptor for 23-inch rack)

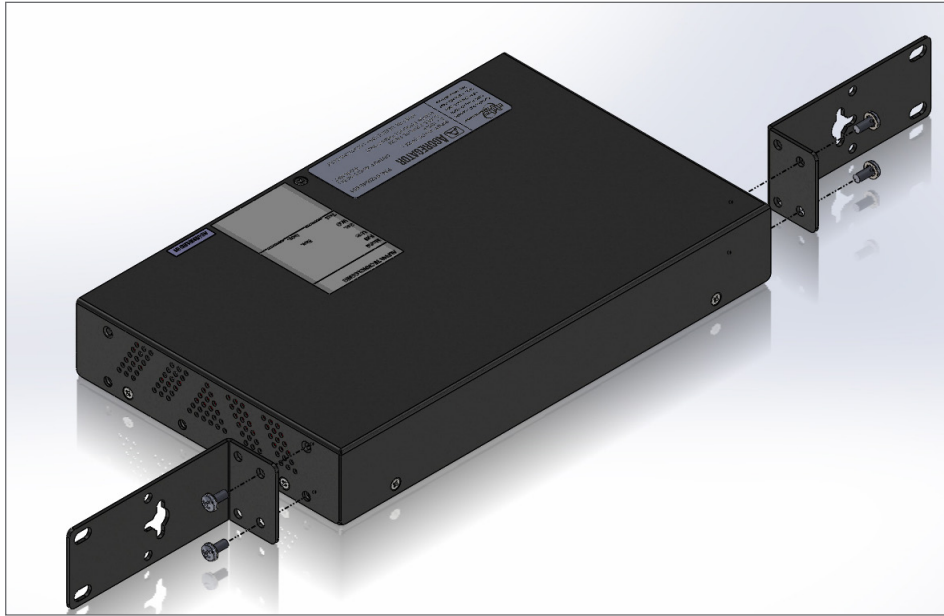

Figure 6: Bracket installation, offset rack mount

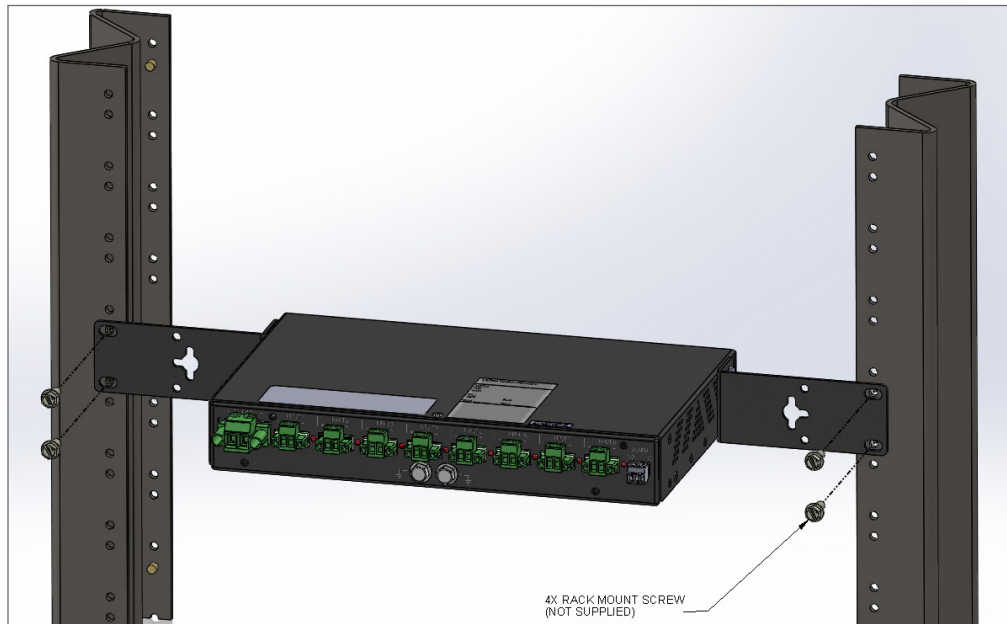

Figure 7: Installation, offset rack mount

### 6.5.3 Wall mount

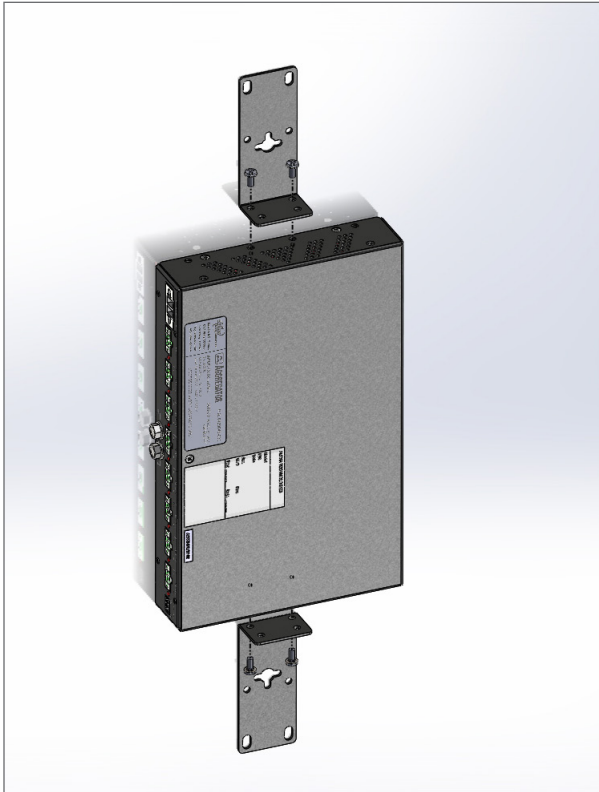

Figure 8: Bracket installation, wall mount

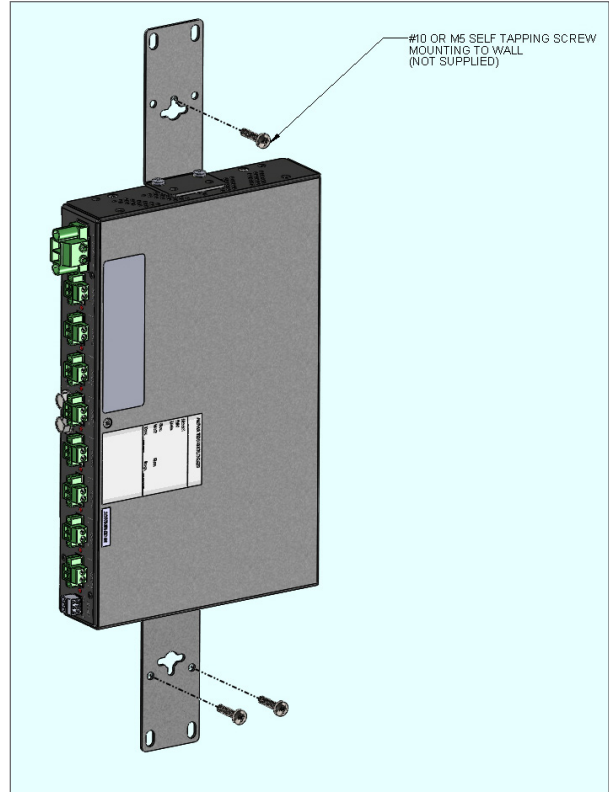

Figure 9: Installation, wall mount

### 6.5.4 Rear (wall) mount

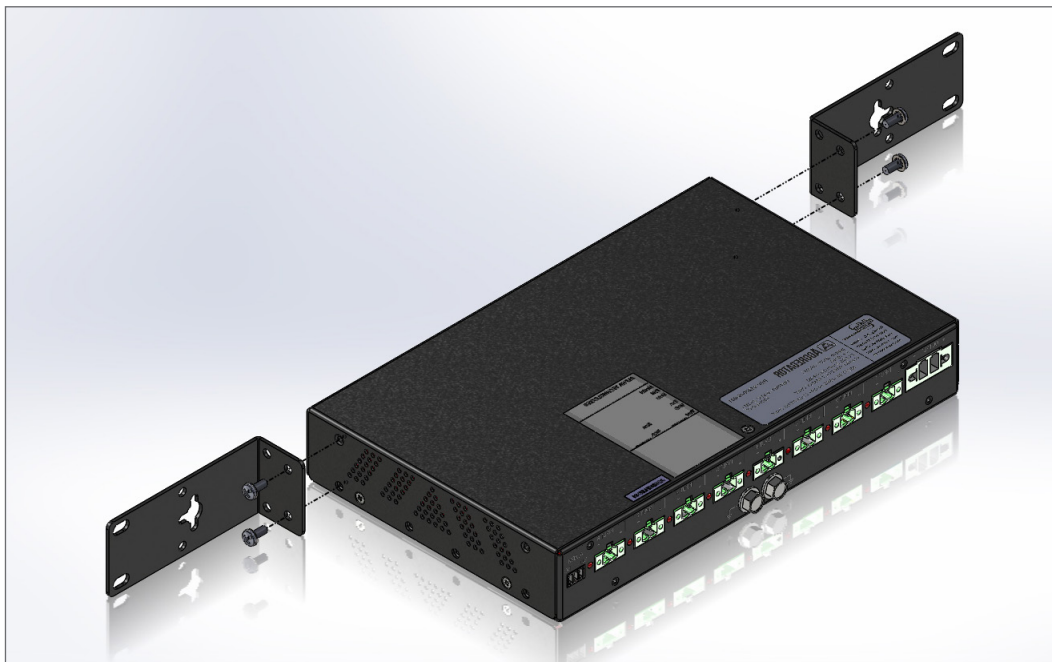

Figure 10: Bracket installation, rear wall mount

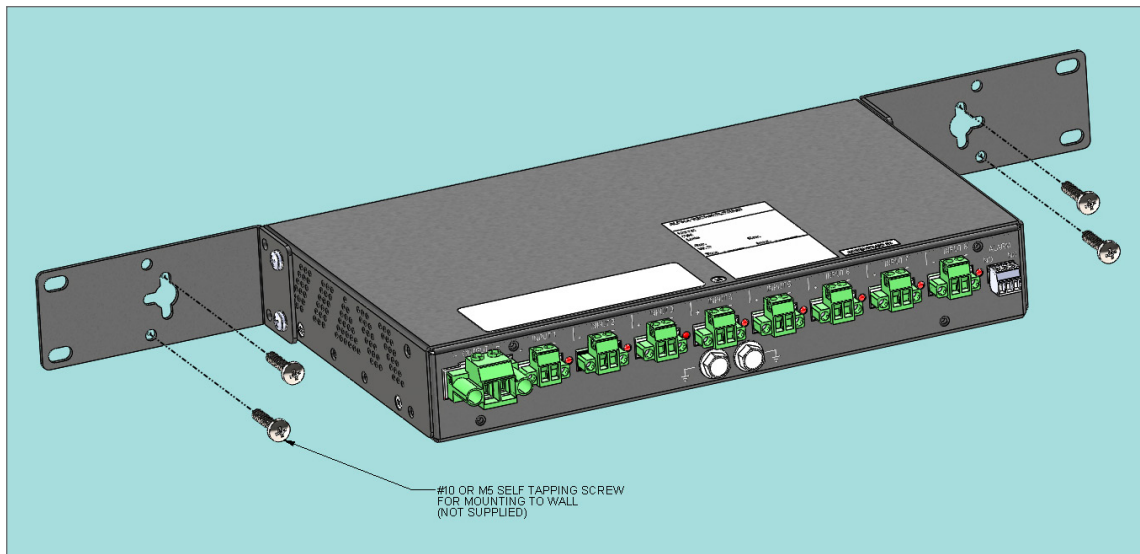

Figure 11: Installation, rear wall mount

## 6.6 Thermal management

The 8-Port iDAS Aggregator can be mounted in different orientations. No matter how the aggregator is orientated, vent holes shall not be blocked and aggregator shall not be stacked over or right next to another aggregator or any other heat generating equipment. Leave at least a 4.5 cm (1.75 in.) air gap for proper cooling.

### WARNING!

**If the unit is installed in an environment that exceeds 46°C (115°F) ambient temperature, forced air cooling is required from an external source providing a minimum of 8.24 l/s (200 LFM) air flow.**

## 6.7 Wiring the 8-Port iDAS Aggregator

This power system is suitable for installation as part of a Common Bonding Network (CBN) and is intended to be used in a DC-I configuration (isolated from frame ground).

The 8-Port iDAS Aggregator can be used on both the eLimiter classic and the eLimiter+.

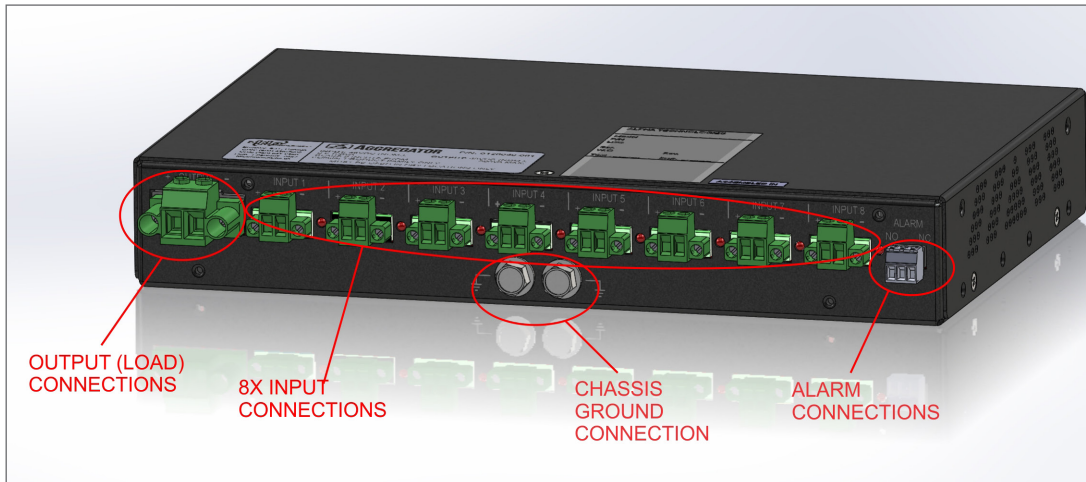

Figure 12: Input and output wiring

Chassis ground connection is provided on the front panel for protective earthing terminals.

Connect the 8-Port iDAS Aggregator to the building master ground bus (MGB). This connection is necessary for personnel safety and to meet many Telco-grounding requirements.

1. Use minimum 16 mm<sup>2</sup> (6 AWG) copper wire and standard two hole crimp lug for ¼ inch holes on ⅝ inch centers.
2. Remove the two flange bolts from unit front panel.
3. Secure the lug with the two flange bolts removed, torque to recommended values.

Table A — Torque values	
Recommended torque values	
¼" - 20	11.86 Nm (105 in-lbs.)



## NOTE

eLimiter+ (PN: 0300156-001) Group Reset switch must be enabled as well as all input channels must be supplied from the same group. Refer to eLimiter+ manual (User Guide ID: 0120028-J0).

## WARNING!

Only use Alpha eLimiter Classic or eLimiter+ Class 2 power sources for the 8-Port iDAS Aggregator.

The 8-Port iDAS Aggregator shall not be used to connect Class 2 power inputs from more than one eLimiter Classic or eLimiter+ shelf.

## WARNING!

Before powering up the module, ensure that all Class 2 power inputs to the 8-Port iDAS Aggregator module are wired properly and there shall not be cross-wiring with two or more input channels (see the following example diagram).

Failure to observe this precaution will trip the internal fuse as a protection and make the module permanently inoperational.

### Proper method:

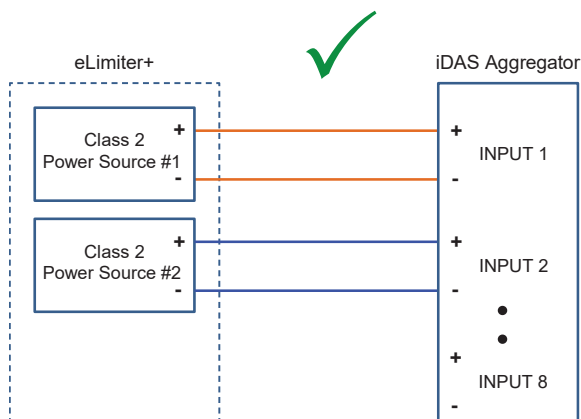

### Incorrect method:

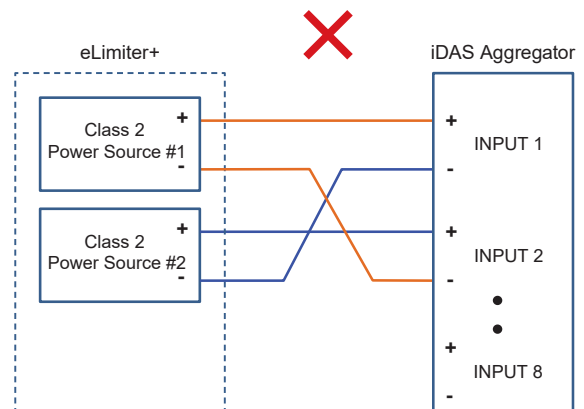

Note 1: Different wire colors are used for reference purpose only.

Note 2: Cross-wiring could EITHER be on the Positive or Negative terminal.

## 6.7.1 Making load connections

Load connections are made with a two-position plug-in terminal blocks (provided with the unit).

- Wire size range: 0.05 mm<sup>2</sup> to 6.0 mm<sup>2</sup> (30 AWG to 10 AWG)
- Wire strip length: 7 mm (0.27 in.)
- Terminal screw torque: 0.5 Nm (4.4 in-lb)

## 6.7.2 Wiring the alarm relays

One Form C relay contact is available for general alarm (located on the front-right side of the unit).

Connect the relay contacts via the three-position plug-in terminal block (provided with the unit) to the local alarm-sending circuit using appropriate wire gauges from 0.08 mm<sup>2</sup> to 1.5 mm<sup>2</sup> (28 AWG to 16 AWG). The NO/C/NC positions for each alarm are shown in [Figure 12](#) and [Figure 13](#).

Alarm wire connections:

- Wire size range: 0.08 mm<sup>2</sup> to 1.5mm<sup>2</sup> (28 AWG to 16 AWG)
- Wire strip length: 7 mm (0.27 in.)
- Terminal screw torque: 0.19 Nm (1.7 in-lb)

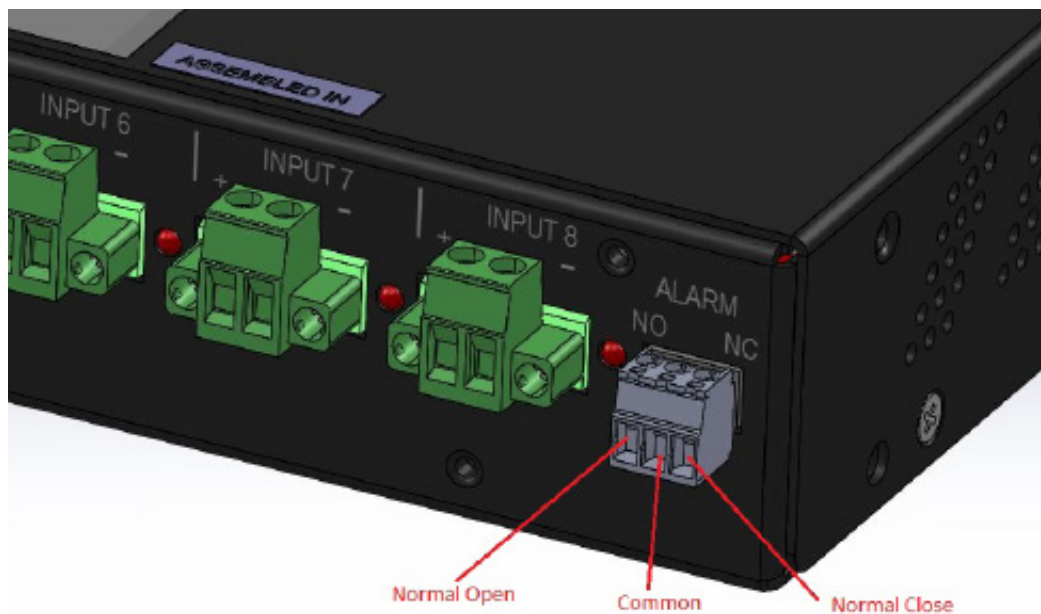

Figure 13: Alarm positions

## 6.8 Installing the wire cover and securing the wires

The wire cover can be installed in the normal way with the cover on the top or turned 180 degrees. See the following images.

Once the load and input wiring connections are complete and secured with cable ties, install the wire cover.

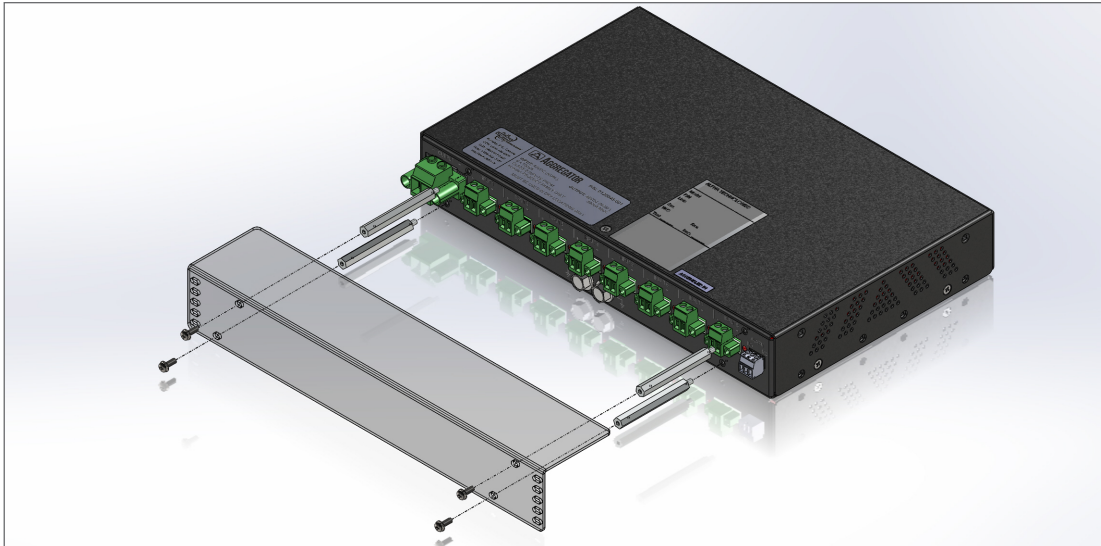

Figure 14: Wire cover, normal installation



Figure 15: Wire cover, complete

### 6.8.1 Channel designation label

The iDAS Aggregator comes with a blank Channel designation label to physically label each input channel. No special pen is required to write on this card. Fill in the label and attach to the front or top of the wire cover.



 	CH	DESCRIPTION	CH	DESCRIPTION	CH	DESCRIPTION	CH	DESCRIPTION
	1		3		5		7	
	2		4		6		8	

Figure 16: Channel designation label

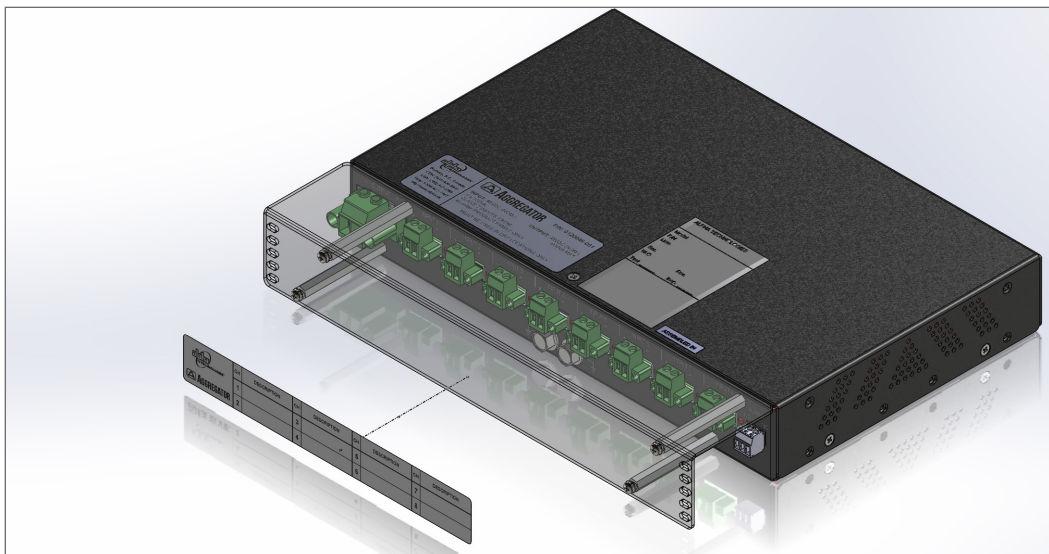

Figure 17: Channel label install front

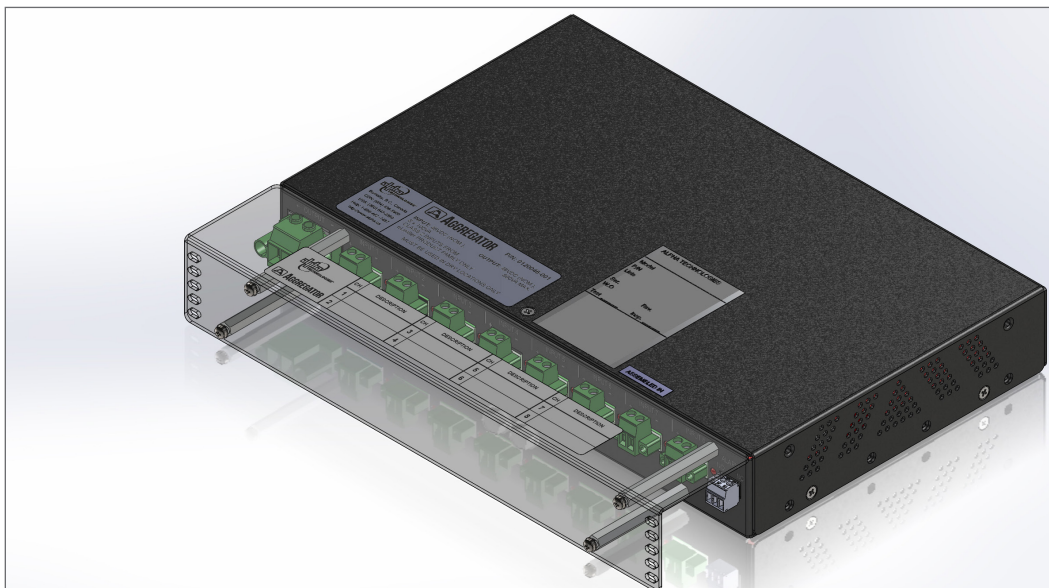

Figure 18: Channel label install top

## 6.9 Wiring the 4-Port iDAS Aggregator

### NOTE

- All inputs of a 4-Port iDAS Aggregator must be powered by one or two eLimiter+ modules installed in the same shelf.
  - If two eLimiter+ modules are used, refer to the eLimiter+ manual (User Guide ID: 0120028-J0) for the correct group reset configuration.
  - Make sure to remove the screw terminal block from the rear of the eLimiter+ shelf before beginning the wiring process.
  - 4-Port iDAS Aggregator must be powered from an eLimiter+ shelf only.
1. Connect the 4-Port iDAS Aggregator to the building master ground bus (MGB) via the ground screws on the front of the unit. Use minimum 16 mm<sup>2</sup> (6 AWG) cable and standard two-hole crimp lug for ¼ inch holes on ⅝ inch centers.
  2. Connect the 4-Port iDAS Aggregator output to the load.

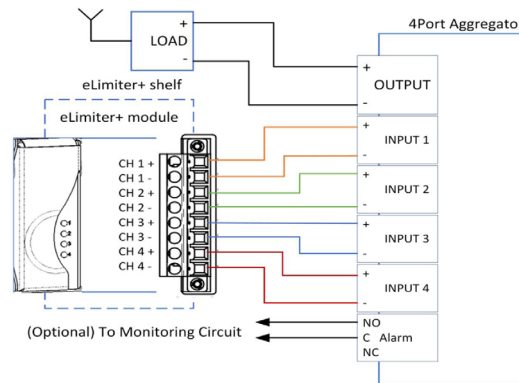

Figure 19: Wiring connections

3. Wire the connections between the 4-Port iDAS Aggregator and the eLimiter+ shelf according to [Figure 20](#).
4. (Optional) Wire the alarm relays to a monitoring circuit if applicable:
  - The relay is energized when the unit is powered and no error is present.
  - Ensure the fusing and gauge of signal wire is according to local and national codes.

### 6.9.1 Startup

1. Remove the eLimiter+ modules powering the 4-Port iDAS Aggregator from the shelf socket.
2. Connect the screw terminal block to the respective output socket at the rear of the eLimiter+ shelf and re-insert the eLimiter+ modules into the shelf.
3. The 4-Port iDAS Aggregator unit should display a green or blinking green LED for each channel connected to an eLimiter+ module which indicates the load is energized. If a green or blinking green LED is not detected, refer to "[6.10 Troubleshooting](#)".



### WARNING!

**Only use Alpha eLimiter+ Class 2 power sources for the 4-Port iDAS Aggregator.**

**The 4-Port iDAS Aggregator shall not be used to connect Class 2 power inputs from more than one eLimiter+ shelf.**

## 6.10 Troubleshooting

### 6.10.1 iDAS Aggregator LED states and recommended action

LED state	Alarm relay state	Aggregator status	Load status	Action
Green	Energized	Channel voltage present and current flowing to aggregator.	Load is powered	None
Blinking green	Energized	Channel voltage present and ready to supply current. <b>Note:</b> Blinking green indicates that the channel is active, but is not sensing current. This is the expected case if the inherent drop current sharing had not kicked in yet, especially if: <ul style="list-style-type: none"> <li>The total output power is less than 70% of the total capacity of the input sources, or</li> <li>The span distance is shorter. In this specific case, this is normal operation.</li> </ul>	Load is powered	None
Yellow	De-energized	Internal ambient over temperature (>95°C; >203°F)	Load is not powered until internal ambient temperature is below 95°C (203°F)	Unit resets automatically when internal ambient temperature of the module reduces to approximately 85°C (185°F) or below.
Blinking yellow	De-energized	Channel input voltage out of range (>60V or <35V)	Load is not powered until voltage returns to range (>60V or <35V).	Channel is disabled if input voltage exceeds 60V.
Red	De-energized	100VA limitation exceeded or over current protection (>2.4A)	Load is not powered until overload or short on the aggregator is removed. The aggregator attempts a restart every 2-seconds.	<ul style="list-style-type: none"> <li>Check if all active channels share nearly equal current.</li> <li>Ensure that the line impedance per channel is identical (similar wire gauge, length). Check if there is an overload on the system.</li> </ul>
Blinking red	De-energized	Channel high side and low side current imbalance (>0.7A)	Load is not powered until error is removed. The aggregator attempts a restart every 2-seconds.	<ul style="list-style-type: none"> <li>Check the input connections to ensure that there is no faulty wiring or cross-connection between channels.</li> <li>Current sensor may be faulty. Replace with new module.</li> </ul>
Off	De-energized	<ul style="list-style-type: none"> <li>No power</li> <li>Input voltage is less than 20V</li> <li>Channel fuse input fuse cut off</li> </ul>	Load is not powered	<ul style="list-style-type: none"> <li>Check the input wiring and voltage</li> <li>If voltage is higher than 20Vdc. Potential component failure. Replace with a new module.</li> </ul>

## 6.11 Service parts

Description	Part number
Input terminal block	5350120
Output terminal block	5350124
Alarm terminal block	5350054

## 7. Wiring

This chapter provides cabling details and notes on cable sizing for DC applications with respect to the product.

### 7.1 Calculating output wire size requirements

Although DC power wiring and cabling in telecommunication applications tend to exceed electrical code requirements, mostly due to the voltage drop requirements, all applicable electrical codes take precedence over the guidelines and procedures wherever applicable.

Wire size is calculated by first determining the appropriate maximum voltage drop requirement. Use the formula below to calculate the circular mil area (CMA) wire size requirement. Determine the size and number of conductors required to satisfy the CMA requirement.

$$\text{CMA} = (\text{A} \times \text{LF} \times \text{K}) / \text{AVD}$$

**A = Ultimate drain in amps**

**LF = Conductor loop feet**

**K = 11.1 constant factor for commercial (TW type) copper wire**

**AVD = Allowable voltage drop**

Check again that the ampacity rating of the cable meets the requirement for the installation application. Consult local electrical codes (for example, NEC or CEC) for guidelines. If required, increase the size of the cable to meet the code.

The following table provides cable size equivalents.

Cable size	Circular mils	Square millimeters	Equivalent metric cable
20 AWG	1020	0.519	1
18 AWG	1624	0.8232	1
16 AWG	2583	1.309	1.5
14 AWG	4107	2.081	2.5
12 AWG	6530	3.309	4
10 AWG	10380	5.261	6
8 AWG	16510	8.368	10
6 AWG	26250	13.30	16
4 AWG	41740	21.15	25
2 AWG	66370	33.63	35
0 AWG (or 1/0)	105600	53.48	50 or 70
00 AWG (or 2/0)	133100	67.42	70
0000 AWG (or 4/0)	211600	107.2	120
313 MCM (or kcmil)	313600	159	150 or 185
350 MCM (or kcmil)	350000	177.36	185
373 MCM (or kcmil)	373700	189	185 or 240
500 MCM (or kcmil)	500000	253.36	300
535 MCM (or kcmil)	535300	271	300
750 MCM (or kcmil)	750000	380.00	400
777 MCM (or kcmil)	777700	394	400



## 8. Warranty statement and service information

---

### 8.1 Technical support

In Canada and the US, call toll free **+1 888 462 7487**

Customers outside Canada and the US, call **+1 604 436 5547**

### 8.2 Warranty statement

For full information details review Alpha's online Warranty statement at [www.alpha.ca/support](http://www.alpha.ca/support).

### 8.3 Product warranty

Alpha warrants that for a period of two years from the date of shipment its products shall be free from defects under normal authorized use consistent with the product specifications and Alpha's instructions, the terms of the manual will take precedence.

The warranty provides for repairing, replacing or issuing credit (at Alpha's discretion) for any equipment manufactured by it and returned by the customer to the factory or other authorized location during the warranty period.

There are limitations to this warranty coverage. The warranty does not provide to the customer or other parties any remedies other than the above. It does not provide coverage for any loss of profits, loss of use, costs for removal or installation of defective equipment, damages or consequential damages based upon equipment failure during or after the warranty period. No other obligations are expressed or implied. Warranty also does not cover damage or equipment failure due to causes external to the unit including, but not limited to, environmental conditions, water damage, power surges or any other external influence.

The customer is responsible for all shipping and handling charges. Where products are covered under warranty Alpha will pay the cost of shipping the repaired or replacement unit back to the customer.

### 8.4 Battery warranty

Note that battery warranty terms and conditions vary by battery and by intended use. Contact your Alpha sales representative or the Technical Support team at the above number to understand your entitlements under Battery Warranty.

### 8.5 Warranty claims

Any claim under this Limited Warranty must be made in writing to Alpha **before** sending material back. Alpha will provide Product return instructions upon approval of return request. A Service Repair Order (SRO) or Return Authorization (RA) number will be issued ensuring that your service needs are handled promptly and efficiently.

Claims must be made online at: [www.alpha.ca](http://www.alpha.ca).

### 8.6 Service information

For a list of international service centers, refer to the Alpha website: [www.alpha.ca](http://www.alpha.ca).

# 9. Certification

## About CSA and NRTL

CSA (Canadian Standards Association also known as CSA International) was established in 1919 as an independent testing laboratory in Canada. CSA received its recognition as an NRTL (Nationally Recognized Testing Laboratory) in 1992 from OSHA (Occupational Safety and Health Administration) in the United States of America (Docket No. NRTL-2-92). This was expanded and renewed in 1997, 1999, and 2001. The specific notifications were posted on OSHA's official website as follows:

- Federal Register #: 59:40602 - 40609 [08/09/1994]
- Federal Register #: 64:60240 - 60241 [11/04/1999]
- Federal Register #: 66:35271 - 35278 [07/03/2001]

When these marks appear with the indicator “C and US” or “NRTL/C” it means that the product is certified for both the US and Canadian markets, to the applicable US and Canadian standards. (1)

Alpha rectifier and power system products, bearing the aforementioned CSA marks, are certified to CSA C22.2 No. 60950-01 and UL 60950-01. Alpha UPS products, bearing the aforementioned CSA marks, are certified to CSA C22.2 No. 107.3 and UL 1778.

As part of the reciprocal, US/Canada agreement regarding testing laboratories, the Standards Council of Canada (Canada's national accreditation body) granted Underwriters Laboratories (UL) authority to certify products for sale in Canada. (2)

Only Underwriters Laboratories may grant a licence for the use of this mark, which indicates compliance with both Canadian and US requirements. (3)



## NRTLs capabilities

NRTLs are third party organizations recognized by OSHA, US Department of Labor, under the NRTL program.

The testing and certifications are based on product safety standards developed by US based standards developing organizations and are often issued by the American National Standards Institute (ANSI). (4)

The NRTL determines that a product meets the requirements of an appropriate consensus-based product safety standard either by successfully testing the product itself, or by verifying that a contract laboratory has done so, and the NRTL certifies that the product meets the requirements of the product safety standard. (4)

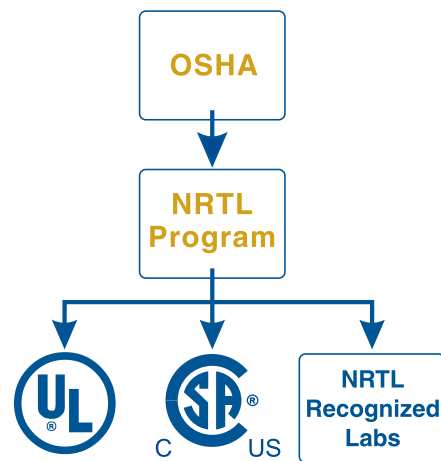

## Governance of NRTL

The NRTL Program is both national and international in scope with foreign labs permitted.

- (1) [www.csagroup.org](http://www.csagroup.org)
- (2) [www.scc.ca](http://www.scc.ca)
- (3) [www.ulc.ca](http://www.ulc.ca)
- (4) [www.osha.gov](http://www.osha.gov)

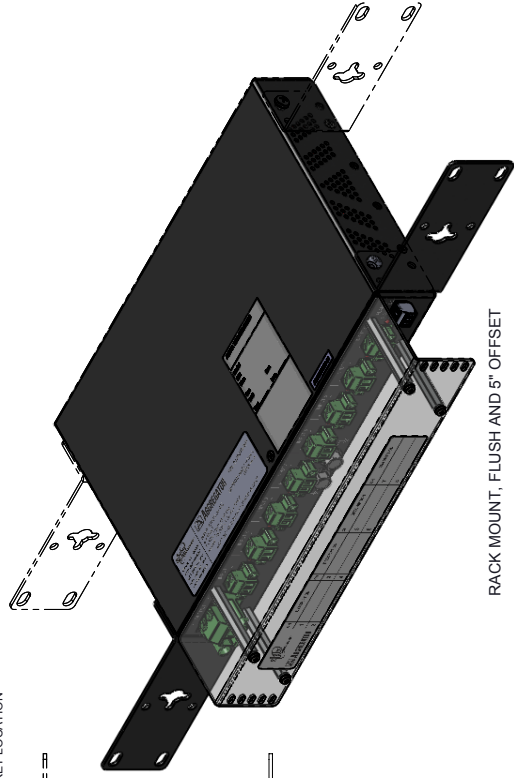
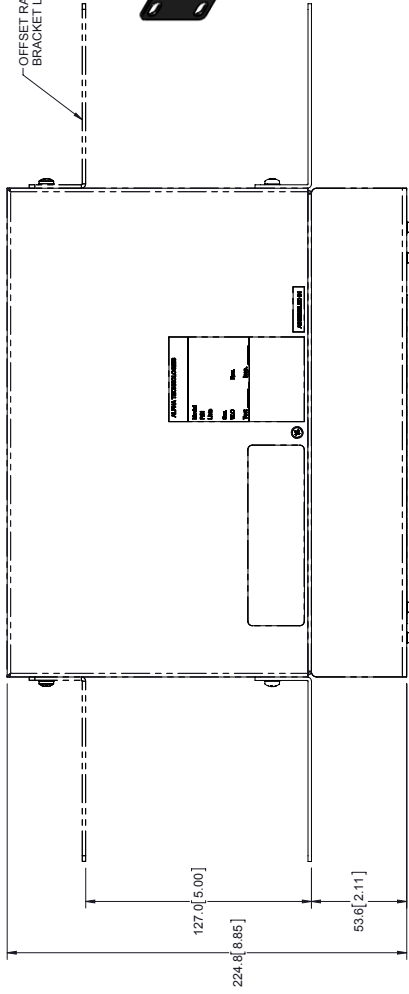

RAK MOUNT, FLUSH AND 5" OFFSET

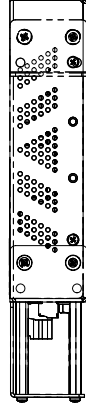
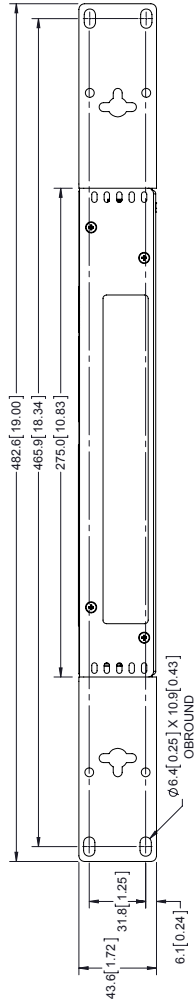

 an EnergySys company	
TITLE: OUTLINE, IDAS AGGREGATOR	
SIZE: DWG NO. 0120046-06	REV: A
SCALE: 1:1	SHEET: 1 OF 3

NOTES UNLESS OTHERWISE SPECIFIED:  
1. DIMENSIONS IN MM [INCH].

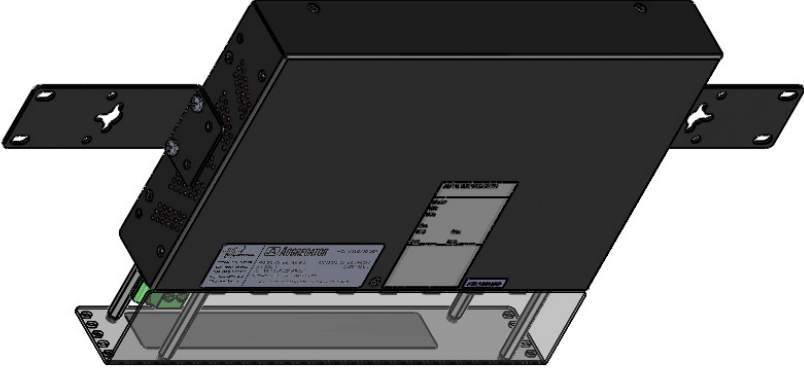
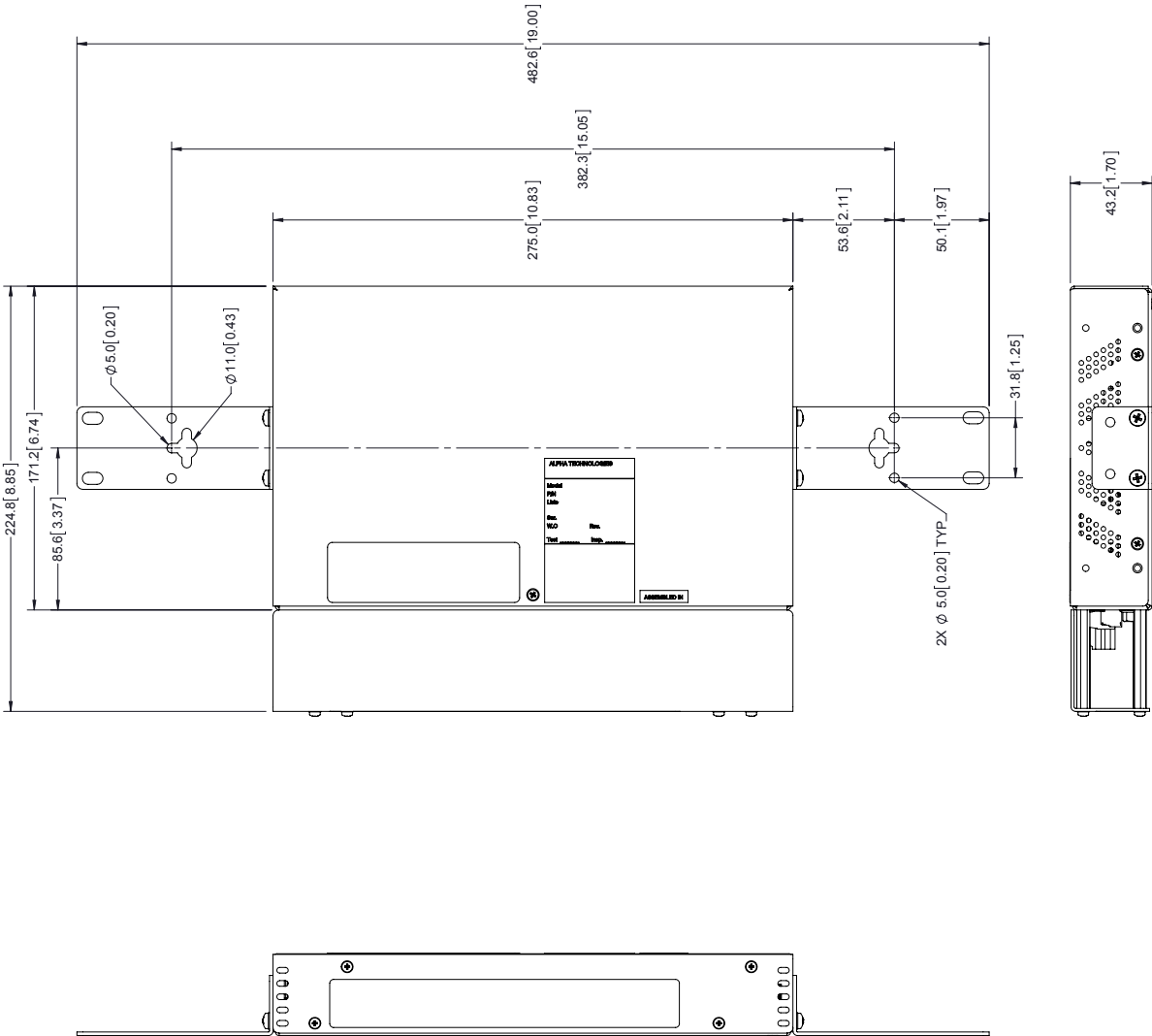

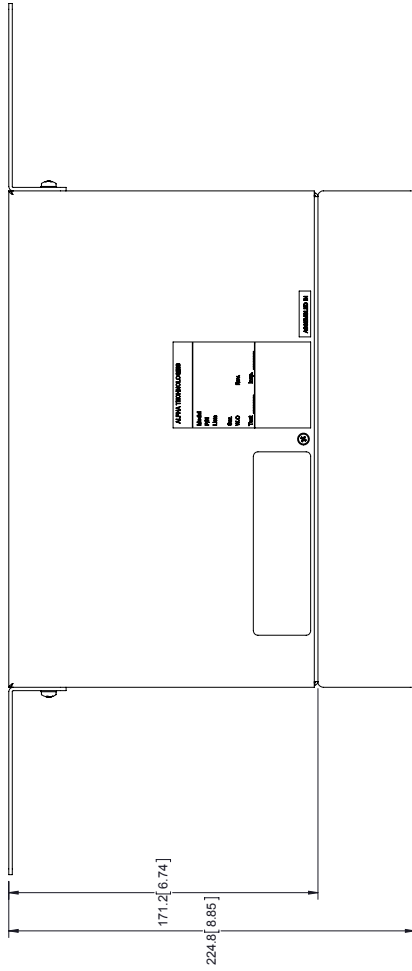
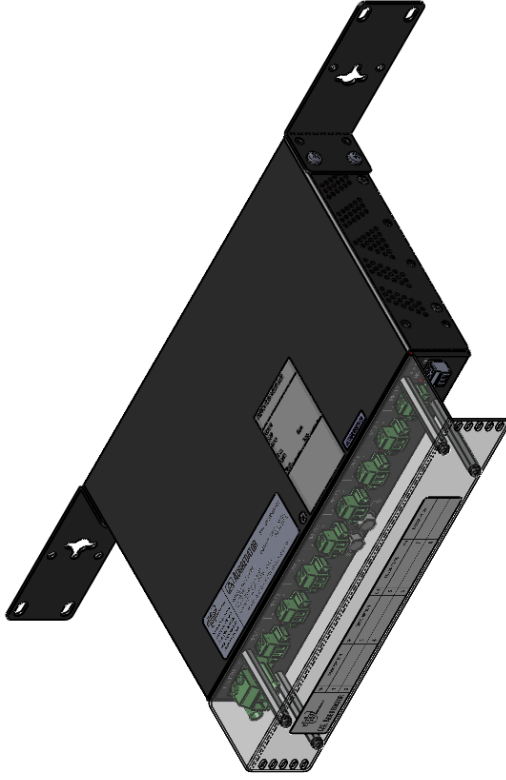

WALL MOUNT

 an EnergySyst company	
TITLE:	OUTLINE, IDAS AGGREGATOR
SIZE DWGNO.	B 0120046-06
SCALE:	1:2.5
SHEET	2 OF 3
REV	A

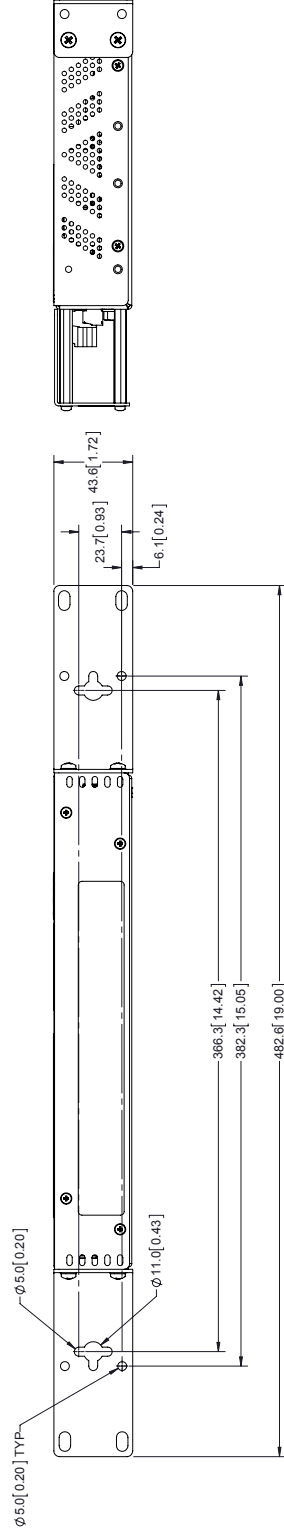

REAR SIDE WALL MOUNT



   on EnerSys company	
TITLE:	OUTLINE, IDAS AGGREGATOR
SIZE DWG NO.	0120046-06
REV	A
SCALE:	1:2.5   SHEET 3 OF 3

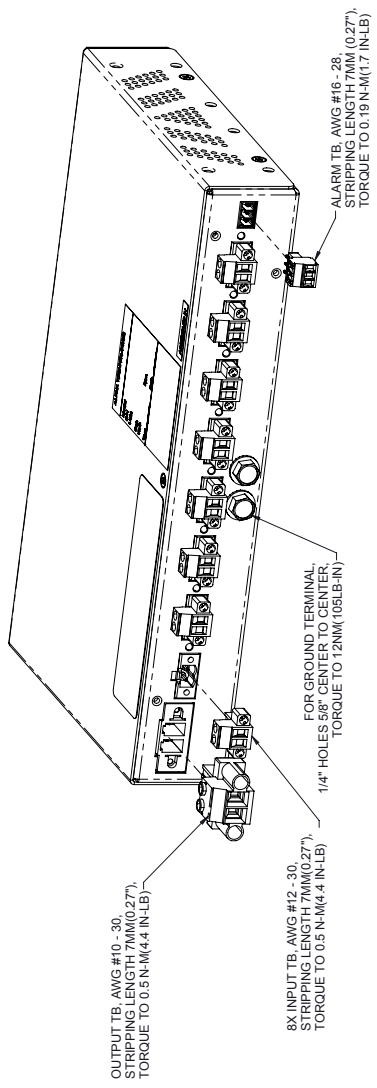

 | an EnergySys company

TITLE: CUSTOMER CONNECTIONS		REV
IDAS AGGREGATOR		A
SIZE	DWG NO.	REV
B	0120046-08	A
SCALE:	1:2	SHEET 1 OF 1

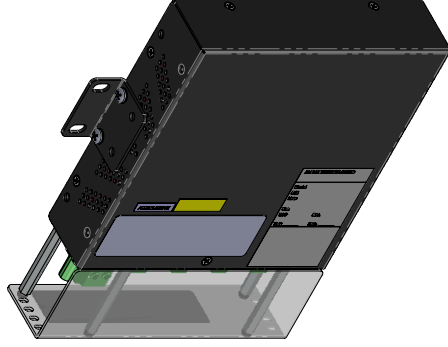
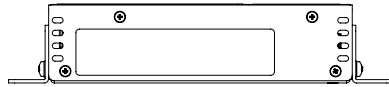
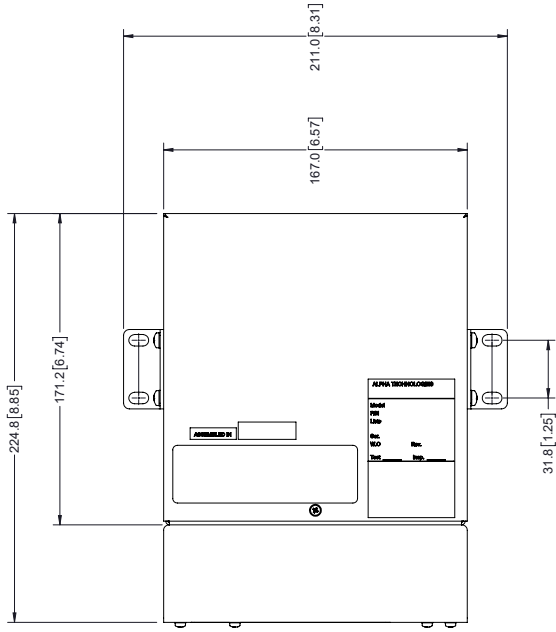

WALL MOUNT

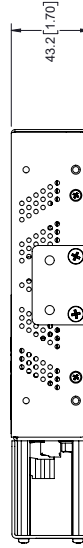

NOTES UNLESS OTHERWISE SPECIFIED:  
 1. DIMENSIONS IN MM (INCH).

 an Ericsson company	
TITLE:	OUTLINE: iDAS 4 PORT AGGREGATOR
SIZE:	DWG NO. 0120081-06
REV	REV A
SCALE:	1:2.5 SHEET 1 OF 2

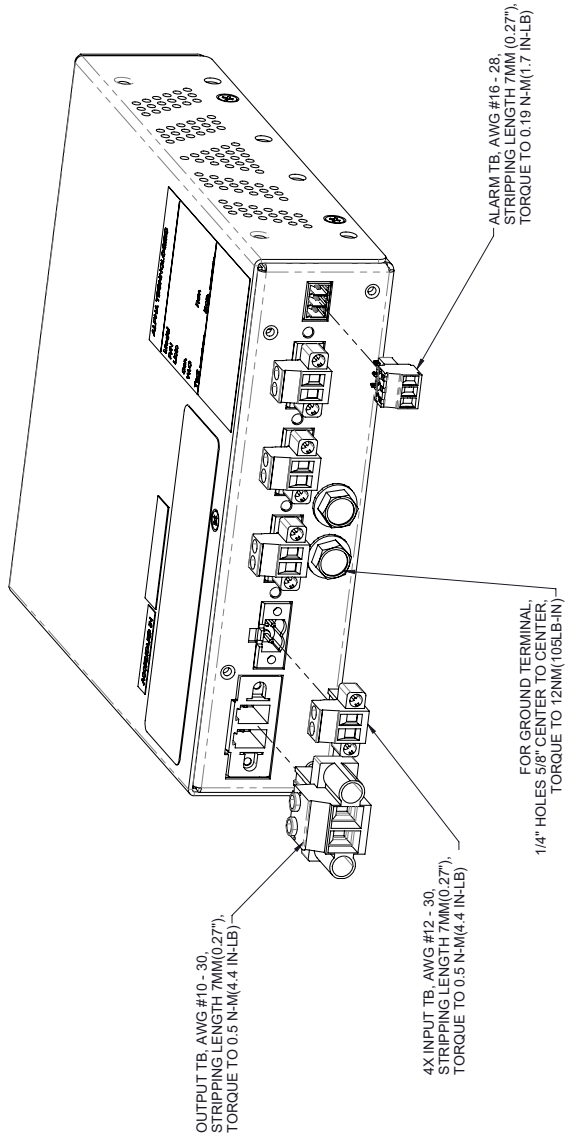

TITLE: CUSTOMER CONNECTIONS  
IDAS 4 PORT AGGREGATOR

SIZE	DWG NO.	REV
B	0120081-08	A
SCALE:	1:2	SHEET 1 OF 1









